

# PROGRESSIVE REHABILITATION AND CLOSURE PLAN

## DUGALD RIVER MINE

MINERALS AND METALS GROUP PTY LTD

May 2024

PREPARED FOR: DEPARTMENT OF ENVIRONMENT  
SCIENCE AND INNOVATION

PREPARED BY: WULGURU TECHNICAL SERVICES

DOCUMENT ID: 2023.07002

VERSION: 5.0

DATE OF SUBMISSION: 24/05/2024

EA HOLDER CONTACT DETAILS: LEVEL 23, 28

FRESHWATER PLACE SOUTHBANK VIC 3006



**WULGURU TECHNICAL  
SERVICES**

## Contact Details

<b>Company</b>	Wulguru Technical Services Pty Ltd
<b>Project Manager</b>	Madison Jackson
<b>Email</b>	<a href="mailto:madison@wulgurutechservices.com.au">madison@wulgurutechservices.com.au</a>
<b>Mail</b>	PO Box 2553 IDALIA QLD 4810
<b>ABN</b>	79 644 301 655



## Disclaimer

This report has been prepared by Wulguru Technical Services Pty Ltd for and on behalf of Wulguru Technical Services Pty Ltd's Client and is subject to and issued in connection with the agreement between Wulguru Technical Services Pty Ltd.

Wulguru Technical Services Pty Ltd cannot be held liable for third party reliance on this document. This report is based on information available to Wulguru Technical Services Pty Ltd and could be different if the information on which this report is based upon is inaccurate or incomplete.

Whilst all reasonable effort has been made to ensure that the contents of this publication are factually correct, Wulguru Technical Services Pty Ltd does not accept responsibility for the accuracy or completeness of the contents and shall not be liable for any loss or damage that may be occasioned directly or indirectly through the use of, or reliance on, the contents of this publication.

This report may utilise the results of work carried out by others. These results have been used in good faith by Wulguru Technical Services Pty Ltd and Wulguru Technical Services Pty Ltd cannot be held responsible for their accuracy.

## Document Control and History

Version	Date	Description	Prepared By	Reviewed By
0.1	9/08/2022	Draft – Client Review	Madison Jackson	Matthew Ayre
0.2	30/09/2022	Draft – Client Review	Madison Jackson	Scott Hayes-Stanley
1.0	2/10/2022	Final	Madison Jackson	Scott Hayes-Stanley
2.0	26/07/2023	Final - Revision, July 2023 EA amendment	Madison Jackson	Nathan Goodwin
V3.0	5/12/2023	Final – NPM Response	Madison Jackson	Madison Jackson
V4.0	10/05/2024	Response to Information Request Notice	Madison Jackson	Madison Jackson

## Citation

Wulguru Technical Services, 2023, *Progressive Rehabilitation and Closure Plan*, Prepared by Wulguru Technical Services Pty Ltd for MMG Dugald River Pty Ltd.



# Contents

1.	Introduction.....	1
2.	Purpose of Plan.....	1
3.	Rehabilitation Planning .....	2
3.1.	Project Planning .....	2
3.1.1.	Project Description .....	2
3.1.2.	Mining Tenements.....	4
3.1.3.	Underlying Landholders .....	5
3.1.4.	Primary Mine Features and Infrastructure On-Site .....	5
3.1.5.	Pre-mining Land Use .....	8
3.1.6.	Communities .....	8
3.1.7.	Native Title .....	9
3.1.8.	Type of Operations.....	9
3.1.9.	Duration Of Operation .....	9
3.1.10.	Existing Environmental Context .....	9
3.1.10.1.	Climate .....	9
3.1.10.1.1.	Rainfall and Temperature.....	9
3.1.10.1.2.	Long-term Climate Projections.....	12
3.1.10.2.	Topography and Hydrology .....	13
3.1.10.2.1.	Topography .....	13
3.1.10.2.2.	Hydrology .....	13
3.1.11.	Surface Water .....	15
3.1.11.1.	Environmental Values .....	15
3.1.11.2.	Water Quality Trigger Limits.....	16
3.1.11.3.	Receiving Environment Monitoring Program .....	18
3.1.11.4.	Surface Water Quality .....	18
3.1.12.	Groundwaters.....	22
3.1.12.1.	Environmental Values .....	22
3.1.12.2.	Groundwater Monitoring Network .....	22
3.1.12.3.	Groundwater Trigger Limits.....	23
3.1.12.4.	Groundwater Quality .....	24

3.1.13. Hydrogeology .....	29
3.1.14. Soils.....	30
3.1.14.1. Soil types.....	30
3.1.14.2. Soil properties .....	31
3.1.14.3. Agricultural Land Classes .....	33
3.1.14.4. Land Suitability Assessment .....	34
3.1.15. Land Stability.....	35
3.1.15.1. Soil Erosion Susceptibility .....	35
3.1.15.2. Erosion Hazard (Average Rainfall).....	36
3.1.16. Geology .....	37
3.1.17. Vegetation Communities and Ecological Data .....	38
3.1.17.1. Matters of National Environmental Significance (MNES).....	38
3.1.17.2. Matters of State Environmental Significance .....	38
3.1.17.3. Environmentally Sensitive Areas.....	38
3.1.17.4. Regional Ecosystems.....	38
3.1.17.5. Regulated Vegetation.....	39
3.1.17.6. Threatened Flora.....	39
3.1.17.7. Threatened Fauna.....	40
3.2. Community .....	43
3.2.1. Community Profile .....	43
3.2.2. Community Consultation Plan.....	43
3.3. Post Mining Land Use .....	44
3.3.1. Rehabilitation Areas .....	44
3.3.2. Existing Rehabilitation .....	48
3.3.3. Assessment of PMLU Options .....	48
3.3.3.1. Community Consultation .....	50
3.3.3.2. Regional Planning Integration .....	51
3.3.3.2.1. Cloncurry Shire Planning Scheme .....	51
3.3.3.2.2. Regional Strategies .....	51
3.3.4. Proposed PMLU.....	54
3.3.4.1. RA1 – Ancillary infrastructure and services .....	54

3.3.4.1.1.	Overview .....	54
3.3.4.1.2.	Outcome .....	54
3.3.4.1.3.	Environmental Benefit .....	54
3.3.4.1.4.	Economic Benefit .....	54
3.3.4.1.5.	Social Benefit .....	54
3.3.4.2.	RA2 – Borrow Pits and Stockpiles .....	54
3.3.4.2.1.	Overview .....	54
3.3.4.2.2.	Outcome .....	54
3.3.4.2.3.	Environmental Benefit .....	55
3.3.4.2.4.	Economic Benefit .....	55
3.3.4.2.5.	Social Benefit .....	55
3.3.4.3.	RA3 – Dams and Diversion Structures .....	55
3.3.4.3.1.	Outcome .....	55
3.3.4.3.2.	Environmental Benefit .....	55
3.3.4.3.3.	Economic Benefit .....	56
3.3.4.3.4.	Social Benefit .....	56
3.3.4.4.	RA4 – Mineralised Waste Dumps .....	56
3.3.4.4.1.	Outcome .....	56
3.3.4.4.2.	Environmental Benefit .....	56
3.3.4.4.3.	Economic Benefit .....	57
3.3.4.4.4.	Social Benefit .....	57
3.3.4.5.	RA5 – Mining and Processing Areas .....	57
3.3.4.5.1.	Outcome .....	57
3.3.4.5.2.	Environmental Benefit .....	57
3.3.4.5.3.	Economic Benefit .....	57
3.3.4.5.4.	Social Benefit .....	58
3.3.4.6.	RA6 – TSF .....	58
3.3.4.6.1.	Outcome .....	58
3.3.4.6.2.	Design .....	58
3.3.4.6.3.	Environmental Benefits .....	58
3.3.4.6.4.	Economic Benefit .....	58

3.3.4.6.5.	Social Benefit .....	58
3.3.4.7.	RA7 – Renewable Energy Infrastructure .....	59
3.3.4.7.1.	Outcome .....	59
3.3.4.7.2.	Economic Benefit .....	59
3.3.4.7.3.	Social Benefit .....	59
3.3.5.	Rehabilitation Milestones .....	59
3.4.	Non-use management areas.....	78
3.5.	Rehabilitation and Management Methodologies.....	78
3.5.1.	Voids in Floodplains .....	78
3.5.2.	General rehabilitation principles.....	78
3.5.2.1.	Site Services .....	78
3.5.2.2.	Contaminated land assessment.....	78
3.5.2.3.	Site Preparation.....	78
3.5.2.4.	Soil Capping and Material Assessment .....	78
3.5.2.5.	Topsoil Management.....	81
3.5.2.5.1.	Topsoil Striping.....	81
3.5.2.5.2.	Topsoil Stockpiling .....	81
3.5.2.5.3.	Topsoil Application .....	81
3.5.2.6.	Erosion and Sediment Control .....	82
3.5.2.7.	Revegetation .....	82
3.5.2.8.	Weed Management.....	83
3.5.2.9.	Water management.....	83
3.5.2.10.	Flooding.....	84
3.5.2.11.	Subsidence management .....	84
3.5.2.12.	Waste characterisation.....	85
3.5.2.12.1.	Methodology.....	85
3.5.2.12.2.	ARD Classification.....	85
3.5.2.12.3.	Elemental Analysis .....	86
3.5.2.12.4.	Identification of waste rock.....	86
3.5.2.12.5.	Waste Rock Dump Design .....	86
3.5.2.12.6.	Implications for Closure.....	87



3.5.2.13.	Final Landform Design .....	87
3.5.2.14.	TSF Closure Design Objectives .....	87
3.5.2.14.1.	Conceptual Tailings Cover System .....	87
3.5.2.14.2.	TSF Embankment and Spillway .....	88
3.5.2.14.3.	TSF Vegetation .....	88
3.5.2.14.4.	Quality Assurance .....	89
3.5.2.14.5.	Rehabilitation Trials.....	89
3.5.3.	Voids .....	90
3.5.4.	Rehabilitation Maintenance .....	91
3.5.5.	Summary of Key Rehabilitation Milestones .....	91
3.6.	Risk Assessment.....	96
3.6.1.	Risk Identification .....	96
3.6.2.	Risk Analysis and Evaluation .....	96
3.7.	Monitoring and Maintenance.....	115
3.7.1.	Rehabilitation Monitoring Phases.....	115
3.7.2.	Establishment of Reference Sites .....	116
3.7.3.	Monitoring Program.....	116
3.7.4.	Initial Monitoring Program .....	117
3.7.4.1.	Desktop Monitoring .....	117
3.7.4.2.	Landform and Erosion .....	117
3.7.4.3.	Soil .....	117
3.7.4.4.	Vegetation .....	118
3.7.4.5.	Fauna .....	119
3.7.4.6.	Surface Waters.....	119
3.7.4.7.	TSF Seepage .....	119
3.7.4.8.	Groundwater.....	119
3.7.5.	Minor Monitoring Methods.....	119
3.7.5.1.	Desktop Monitoring .....	120
3.7.5.2.	Landform and Erosion .....	120
3.7.5.3.	Vegetation .....	120
3.7.5.4.	Surface Water .....	121

3.7.5.5.	TSF Seepage .....	121
3.7.5.6.	Groundwater.....	121
3.7.6.	Major Monitoring Methods.....	121
3.7.6.1.	Desktop Monitoring .....	122
3.7.6.2.	Landform and Erosion.....	122
3.7.6.3.	Soil .....	122
3.7.6.4.	Vegetation .....	122
3.7.6.5.	Grazing Land Suitability Assessment .....	122
3.7.6.6.	Surface Water .....	122
3.7.6.7.	TSF Seepage .....	122
3.7.6.8.	Groundwater.....	122
3.7.7.	Opportunistic Monitoring .....	123
3.7.8.	Maintenance.....	123
3.7.9.	Analysis, Recording, and Reporting.....	123
3.7.10.	Quality Assurance .....	123
3.7.11.	Review.....	124
3.7.12.	EA Relinquishment.....	124
4.	References .....	125
	Appendix A: PRCP Schedule.....	127
	Appendix B: Dugald River TSF Revised Concept Design .....	128
	Appendix C: Surface Subsidence Risk .....	129
	Appendix D: Assessment of the Geochemical Characteristics and ARD Potential of Waste Rock for the Dugald River Zinc, Lead & Silver Deposit.....	130
	Appendix E: Column Cover Trials .....	131
	Appendix F: TSF and Process Area Hydraulic Impact Assessment (ATC Williams, 2021) .....	132
	Appendix G: DRM Community and Social Performance Standard.....	133
	Appendix H: DRM Community Engagement Plan .....	134
	Appendix I: Minutes MMG/Kalkadoon July 2023 .....	135
	Appendix J: Minutes MMG/McMillians October 2023 .....	136

## Tables

Table 1. Granted Tenures for the Dugald River Mine .....	4
Table 2. Underlying Landholder .....	5
Table 3. Mine Features .....	6
Table 4. Temperature Statistics for The Cloncurry Airport (BOM 2023).....	10
Table 5. Rainfall Statistics for the Cloncurry Airport Adapted from BOM 2023 .....	12
Table 6. Local Catchments and Their Mine Features .....	13
Table 7 Receiving Waters Trigger Levels and Contaminant Limits (Schedule C - Table 5 of the EA). 16	
Table 8: Surface Water Chemistry 2020-2021 .....	20
Table 9 Surface Water Chemistry (2020-2022) .....	20
Table 10. Groundwater Bore Details.....	23
Table 11. Groundwater Trigger Levels and Contaminant Limits (EPML00731213) .....	24
Table 12. Groundwater Chemistry (2009-2022) .....	26
Table 13. DRM Soil Types (AARC 2010a).....	30
Table 14 Rehabilitation Related Chemical Properties .....	31
Table 15 Agricultural Land Classes .....	33
Table 16 Agricultural Land Class of the Project soils from AARC (2010).....	33
Table 17 Land Suitability Classes.....	34
Table 18 Land Suitability Assessment for Project soils .....	35
Table 19. Soil Erosion Susceptibility .....	35
Table 20. Erosion Hazard (IECA, 2008) .....	36
Table 21. Mapped Geology for The Project Area .....	37
Table 22. Mapped Vegetation Communities and Their Current Conservation Status (Qld 2021).....	39
Table 24. Rehabilitation Areas and Rehabilitation Milestones.....	44
Table 25. Mine domains and agreed PLMU land classes .....	49
Table 26. Requirements of a PMLU.....	49
Table 27 Preliminary Materials Balance .....	79
Table 28. Stockpiles Topsoil Volumes .....	81
Table 29 Vegetation seed mix .....	83
Table 30. ARD Classification of DRM Waste Rock (EGi, 2010) .....	86
Table 31 Key Rehabilitation and Management Practices .....	92
Table 32. Key Rehabilitation Activities to Achieve Rehabilitation Milestones.....	93
Table 33. Risk Matrix .....	97
Table 34. Risk Evaluation .....	98
Table 35. Analysis Parameters for the Soil Monitoring Program .....	118
Table 36 Preliminary Completion Criteria Summary.....	121

# List of Figures

Figure 1. Project Location .....	3
Figure 2. Minimum and Maximum Monthly Mean Temperatures for the Cloncurry Airport (BOM 2023) .....	10
Figure 3. Monthly Mean Rainfall for the Cloncurry Airport (BOM 2023) .....	11
Figure 4. Cloncurry Airport 9am and 3pm Wind Rose (BOM 2022) .....	12
Figure 5. Topography and Drainage .....	14
Figure 6. Surface Water Monitoring .....	19
Figure 7. Project Groundwater Monitoring Network.....	25
Figure 8. Conceptual Hydrogeological Model for the Dugald River Mine (CGM Smith 2019).....	29
Figure 9. Soil Mapping .....	32
Figure 10. Matters of State Environmental Significance .....	41
Figure 11. Regional Ecosystems .....	42
Figure 12. Rehabilitation Areas.....	47
Figure 13. Proposed Post Mine Land Uses .....	53
Figure 14. Available materials.....	80
Figure 15. Rehabilitation Monitoring Phases .....	115



# 1. Introduction

Dugald River Mine (the Project) is owned and operated by Minerals and Metals Group Pty Ltd (MMG). The Project operates under Environmental Authority EPML00731213 (the EA) and Progressive Rehabilitation and Closure Plan (PRCP) schedule PRCP-EPML00731213-V1. Wulguru Technical Services Pty Ltd (WTS) was engaged by MMG to revise the existing PRCP for activities proposed by an EA amendment application, submitted for assessment in July 2023.

This document summarises the technical components and supporting information relating to the rehabilitation and closure of the Project and has considered the following Department of Environment and Science (DES) guideline:

- Guideline ESR/2019/4964 – *Progressive rehabilitation and closure plans (PRC plans)*, Version 2.00 – 17 March 2021.

The PRCP outlines the Project planning and post-closure requirements, community consultation, post-mining land use, rehabilitation methods, risk assessment, monitoring and maintenance, and rehabilitation schedule.

## 2. Purpose of Plan

The purpose of this document is to assess the existing environmental values and provide for rehabilitation and closure planning based on current disturbances. This PRCP will:

- Outline how MMG will meet landholder expectations for final land use;
- Outline how MMG will achieve a decommissioned site that is safe, fit for purpose, and non-polluting;
- Outline how MMG will minimise residual impact or liability for community and future land holders following rehabilitation; and
- Outline how MMG will return the landform to an agreed or pre-mine condition.

## **3.Rehabilitation Planning**

### **3.1. Project Planning**

#### **3.1.1. Project Description**

DRM is located approximately 63 km northwest of Cloncurry, in north-western Queensland (Figure 1).

The DRM ore body was discovered in the late 1900s following early small-scale mining and prospecting. The explorers identified gossanous zinc/ lead/ silver outcropping between two main drainage features on the plains below the Knapdale Range. Evidence of the outcropping is still visible within a demarcated area of the mines surface features. The surrounding area is littered with surficial copper oxide deposits as well as historic small scale mining features including waste dumps, collapsed shafts and rusted infrastructure (Wulguru Technical Services Pty Ltd, 2021).

Systematic exploration of the deposit began in the 1950s. Zinifex Australia Limited started the most recent phase of exploration in 2004 who subsequently began the process of gaining State and Federal approvals. During this period, the Project was purchased by Minerals and Metals Group (MMG) with approval being granted in 2012 and the first phase of construction (earth works, waste rock pads and dams and underground development) following in 2013. After a brief pause mid-construction to more thoroughly investigate the mining methodology, the Project was completed early 2017. MMG shipped the first parcel of zinc concentrate later that year (Wulguru Technical Services Pty Ltd, 2021).





Client: Minerals and Metals Group  
 Project number: 2023.07002  
 CRS: GDA2020 EPSG:7844  
 Date: 27 July 2023

Print as A3



**Figure 1. Project Location**

- Legend**
- Key Features
  - State Roads
  - Mine Lease
- ESRI Satellite

Disclaimer:  
 Whilst every effort and care has been taken to ensure the accuracy of this report, Wulguru Technical Services Pty Ltd makes no representations or warranties about its accuracy, reliability, completeness or suitability for any particular purpose and disclaims all responsibility and all liability (including without limitation, liability in negligence) for all expenses, losses, damages (including indirect or consequential damage) and costs which you might incur as a result of the product being inaccurate or incomplete in any way and for any reason.  
 Digital data for this report is available on the Queensland Government Spatial Portal at <https://qldspatial.information.qld.gov.au>.





### 3.1.2. Mining Tenements

The project encompasses 40 mining leases and one mineral development lease, as detailed in Table 1.

**Table 1. Granted Tenures for the Dugald River Mine**

Permit	Permit Name	Area (ha)	Land Tenure
MDL 79	NA	227.59	59TG40; 36AP23793; 92SP303378
ML 2467	DUGALD 1	16.21	27B15753; 36AP23793
ML 2468	DUGALD 2	16.21	27B15753; 35B15753; 36AP23793
ML 2469	DUGALD 3	16.2	35B15753; 36AP23793; 36B15753
ML 2470	DUGALD 4	16.19	36AP23793; 36B15753
ML 2471	DUGALD 5	16.19	36AP23793
ML 2477	DUGALD 6	32.51	36AP23793
ML 2478	DUGALD 7	129.49	36AP23793; 92SP303378
ML 2479	DUGALD 8	32.37	36AP23793; 92SP303378
ML 2480	DUGALD 9	32.37	36AP23793; 92SP303378
ML 2481	DUGALD 10	129.49	36AP23793; 92SP303378
ML 2482	DUGALD 11	32.37	36AP23793
ML 2496	DUGALD RIVER NO 6	129.49	36AP23793
ML 2497	DUGALD RIVER NO 7	8.09	36AP23793
ML 2498	DUGALD RIVER 8	29.06	36AP23793; 36B15753
ML 2499	DUGALD RIVER 9	28.08	36AP23793
ML 2500	DUGALD RIVER 10	28.35	36AP23793
ML 2501	DUGALD RIVER 11	30.4	36AP23793
ML 2502	DUGALD RIVER 12	31.63	36AP23793
ML 2556	CLANDESTINE 7	127.72	36AP23793; 92SP303378
ML 2557	CLANDESTINE 8	129.14	36AP23793
ML 2558	CLANDESTINE 13	128.5	36AP23793; 92SP303378
ML 2559	CLANDESTINE 14	98.7	36AP23793; 92SP303378
ML 2596	DUGALD RIVER 51	19	36AP23793
ML 2599	DUGALD RIVER 57	44.77	36AP23793; 92SP303378
ML 2601	DUGALD RIVER 61	28.5	36AP23793
ML 2638	KNAPDALE	122.51	36AP23793; 92SP303378
ML 2684	DUGALD NO 12	1.05	36AP23793
ML 2685	DUGALD NO 13	2.45	36AP23793
ML 7496	DUGULD	24.76	27B15753; 35B15753; 36AP23793
ML 90047	KNAPDALE NO 2	8.36	36AP23793
ML 90049	DUGALD SOUTH NO 7	0.31	36AP23793
ML 90050	DUGALD SOUTH NO 8	0.22	36AP23793
ML 90051	SCANLAN NO 6	9.59	36AP23793
ML 90211	DUGALD TSF	642.67	36AP23793; 92SP303378
ML 90212	DUGALD TXS1	100.48	36AP23793; 92SP303378
ML 90213	DUGALD TXS2	31.7	36AP23793; 92SP303378



ML 90218	DUGALD WPIPE	43.49	5AP23793; 36AP23793
ML 90220	DUGALD PLINE	507.93	2BD56; 3635SP274652; 36AP23793; 3AP23793; 4144SP256851; 521CP905413; 7CP905412; 91SP303378; 92SP303378
ML 90230	DACCESS	120.32	2577PH139; 36AP23793; 92SP303378; 211SP136468
ML 90237	DUGALD TXS3	20.5	36AP23793; 92SP303378

### 3.1.3. Underlying Landholders

The underlying landholders are shown in in Table 2.

**Table 2. Underlying Landholder**

Permit	Lot	Plan	Landholder
MDL 79, ML 2467, ML 2468, ML 2469, ML 2470, ML 2471, ML 2477, ML 2478, ML 2479, ML 2480, ML 2481, ML 2482, ML 2496, ML 2497, ML 2498, ML 2499, ML 2500, ML 2501, ML 2502, ML 2556, ML 2557, ML 2558, ML 2559, ML 2596, ML 2599, ML 2601, ML 2638, ML 2684, ML 2685, ML 7496, ML 90047, ML 90049, ML 90050, ML 90051, ML 90211, ML 90212, ML 90213, ML 90218, ML 90220, ML 90230, ML 90237	36	AP23793	Unallocated State Land
MDL 79, ML 2478, ML 2479, ML 2480, ML 2481, ML 2556, ML 2558, ML 2559, ML 2599, ML 2638, ML 90211, ML 90212, ML 90213, ML 90220, ML 90230, ML 90237	92	SP303378	Harold Henry McMillan
MDL 79, ML 90211	59	TG40	North Australian Pastoral Co Pty Ltd
ML 7496	27	B15753	MMG Australia Limited
ML 7496	35	B15753	MMG Australia Limited
ML 7496	36	B15753	MMG Australia Limited
ML 90230	211	SP136468	Queensland Rail
ML 90220	521	CP05413	Jersey Plains Pastoral Company
ML 90220	3635	PH2175	Cameron Creek Pastoral Co Pty Ltd

### 3.1.4. Primary Mine Features and Infrastructure On-Site

The approved mine features, including proposed additional disturbances, are defined in Table 3.

**Table 3. Mine Features**

Mine Domain	Mine Feature Name	Maximum Disturbance Area (hectares)
Ancillary Infrastructure and Services	Accommodation Village and sewage treatment plant	24.3
	Pipeline and Accommodation Village Road	6
	Communications tower	0.06
	Powerline	67
	Raw water pipeline	12.7
	Roads and Tracks	66.4
	Groundwater infrastructure	0.54
Borrow Pits & Stockpiles	Borrow Pit/Topsoil Stockpile, Borrow Pit A, and Topsoil Stockpile A	16.98
	Borrow Pit B	2.5
	Borrow Pit C1	1.1
	Borrow Pit C2	1.8
	Access Road Borrow Pit(s)	5
	TSF Borrow Pit A	8.3
	TSF Borrow Pit B	
	TSF Stockpile	
	Topsoil Stockpile B	9.7
	Spoil Stockpile 1	0.65
	Spoil Stockpile 2	1.5
Dams and Diversion Structures	Diversion Drains	2
	Stage 1 PAF PAD Run Off Dam	2.25
	Stage 2 PAF PAD Run Off Dam	11.7
	Underground Mine Water Collection Dam	0.65
	STP Dam Stage 1	0.9
	STP Dam Stage 2	4
	ROM Area Run Off Dam	3.7
	Raw Water Dam	1.8
	Sediment Dam A	1.1

	Process Plant Run Off Dam	1.5
	Containment Dam	0.6
	Mine Workshop Run Off Dam	0.6
	Sediment Dam C	4.5
	Sediment Dam D	3.5
	Sediment Dam F	1.4
	Sediment Dam G	1.4
Exploration	Drill Pads	10
Mineralised Waste	NAF waste rock dump	8
	NAF waste rock dump bund	
	PAF waste rock dump (Stage 1)	1.6
	PAF waste rock dump (Stage 1 Extension)	1.1
	PAF waste rock dump (Stage 2)	9.5
Mining and Processing Area	West Laydown Area	10.3
	Waste Transfer Station	0.25
	Explosives magazine	0.6
	Fuel Storage	0.2
	Temporary Waste Laydown	1
	Construction Laydown, Warehouse, Mobile Equipment Laydown and Core Shed	6.8
	North decline	1
	South decline	1
	Ventilation shaft 1	0.05
	Ventilation shaft 2	0.05
	Ventilation shaft 3	0.05
	Ventilation shaft 4	0.05
	Ventilation shaft 5	0.05
	Ventilation shaft 6	0.05
	Ventilation shaft 7	0.05
Ventilation shaft 8	0.05	
Ventilation shaft 9	0.54	

	Run of Mine (ROM) Pad	3.8
	ROM Haul Roads	3.6
	Processing Plant and Conveyor Area	14.3
	Switchyard 1	1.04
	Switchyard 2	0.99
	Exploration camp and Camp Expansion Works	2.8
	Sewage Treatment Plant	0.38
	Workshop, Vehicle Washdown and Maintenance Area	3.8
	Office & Administration Buildings	10.6
	Laydown east	6.47
Tailings Storage Facility (TSF)	TSF and Seepage Collection Pond	207
	TSF Pipelines and Roads	5.7
Renewables	Wind Farm and Ancillary Infrastructure	29.73
	Laydown west	6.30
	Access Roads	32.32

### 3.1.5. Pre-mining Land Use

The DRM is located on Roseby Station pastoral leases. Prior to the development of the operation, the area was used for cattle grazing. The site also contained several small, abandoned mine workings and previous exploration disturbance.

### 3.1.6. Communities

The nearest residential area is the McMillan family residence at Roseby Station, approximately 6 km from the operational area.

The DRM is located within the Mount Isa Mineral Province. This region is characterised by mineral exploration, mining and pastoral activities. Cloncurry is located 65 km southeast of the Project. Cloncurry's population is approximately 3,000 with the primary industries being cattle grazing and mining. The nearest regional centre is Mount Isa, located 80 km southwest of DRM. Mount Isa has a population of over 18,000 and is the administrative, commercial and industrial centre for north-western Queensland.

The Project ML area does not contain areas of regional interest (priority living areas, priority agricultural areas, strategic cropping land and strategic environmental areas) protected under the *Regional Planning Interests Act 2014* (QLD, 2021).



### **3.1.7. Native Title**

The Kalkadoon Native Title Aboriginal Corporation (the Kalkadoon People) are the Registered Native Title Claimants of the land in and surrounding the Project.

Part of the southern section of the powerline to site is in the Mitakoodi and Mayi People's Native Title claim. The Mitakoodi and Mayi people have not achieved formal Native Title determination, however they are generally recognised to have ties to the areas directly surrounding the Cloncurry township.

A Cultural Heritage Management Agreement is in place for each group.

### **3.1.8. Type of Operations**

The zinc/lead/silver ore is mined from underground by conventional mechanised methods (long hole open stoping and down hole benching methods). Ore and waste are drilled and blasted prior to excavation. The mine is accessed by twin declines that are also used to haul ore and waste from the mine.

The ore is processed onsite, then transported by rail to the Port of Townsville. Process tailings are pumped to the Tailings Storage Facility (TSF) with a portion to be reused as paste fill underground once operations have ceased.

Exploration drilling also occurs within the mining leases and on the mineral development lease. There is no other activity conducted on the mineral development lease.

### **3.1.9. Duration Of Operation**

The Project began in 2018 with a Life of Mine (LOM) estimated to be 29 years (i.e., 2047).

An approved rehabilitation schedule is provided in PRCP-EPML00731213-V1, with works scheduled to commence in 2048. Where land becomes available for rehabilitation earlier than the nominated date, progressive rehabilitation will commence as soon as practical.

Where progressive rehabilitation occurs, it is expected that at least one wet season will be needed to establish vegetation. As such each rehabilitation campaign is to be completed, at the latest, by October of each year to allow for vegetation establishment prior to the wet season and to minimise erosion potential.

### **3.1.10. Existing Environmental Context**

#### **3.1.10.1. Climate**

##### **3.1.10.1.1. Rainfall and Temperature**

Peel et al (2007), describes the regional climate as mid-latitude steppe and arid (BSh) using the updated Köppen-Geiger Climate Classification map. Typically, the region endures hot monsoonal summers and cold dry winters.

Statistics from the nearest Bureau of Meteorology weather station at the Cloncurry Airport (BOM 2021 - Station ID 29141 1978-current) generalise a 12°C spread of the mean monthly minimum and maximum

daily temperatures during summer while increasing to 14°C in winter (Figure 2). The highest mean monthly temperatures are recorded in December and the lowest in July (Table 4).

Most rainfall measured at the Cloncurry Airport is received between January and February (Figure 3) with an annual average rainfall of 501.1 mm. With only 35 days where rainfall is ≥ 1mm, short and intense storm events are common (Table 5).

The predominant wind direction is south-southeast (Figure 4).

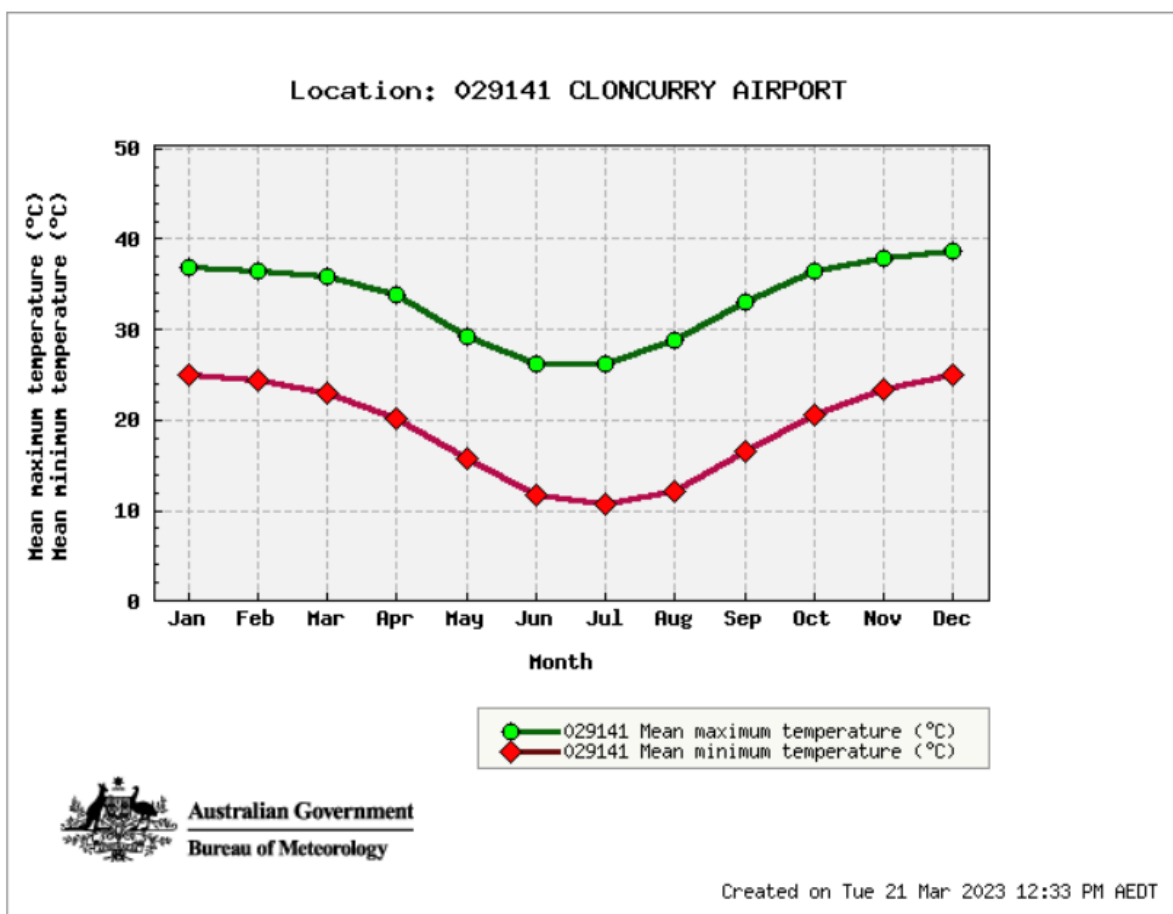


Figure 2. Minimum and Maximum Monthly Mean Temperatures for the Cloncurry Airport (BOM 2023)

Table 4. Temperature Statistics for The Cloncurry Airport (BOM 2023)

Statistic	Jan	Feb	Mar	Apr	May	Jun	Jul	Aug	Sep	Oct	Nov	Dec	Annual
Mean Temp max (°C)	36.9	36.4	35.9	33.8	29.3	26.2	26.3	28.8	33.1	36.5	37.9	38.7	33.3
Mean Temp min (°C)	25.1	24.3	23.0	20.2	15.7	11.8	10.8	12.2	16.6	20.6	23.3	25.0	19.0

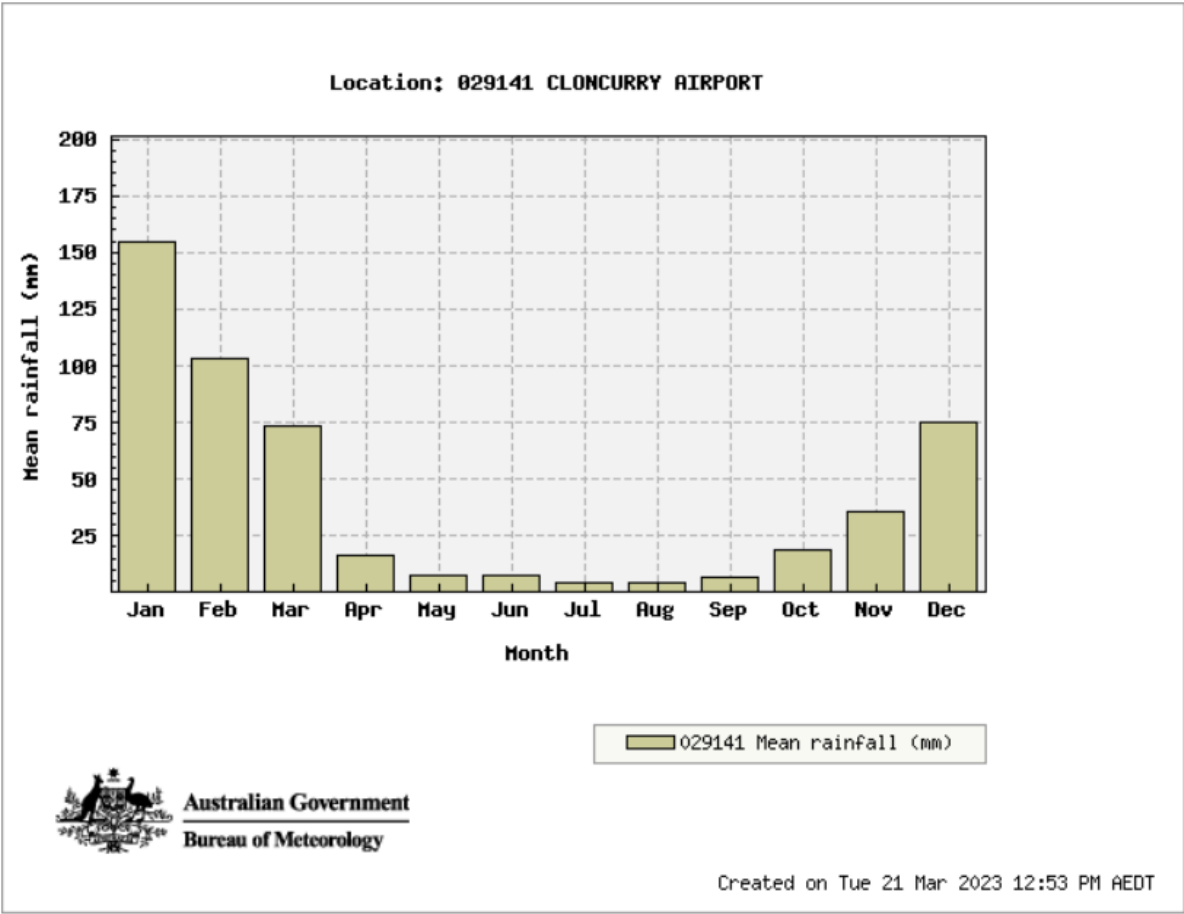
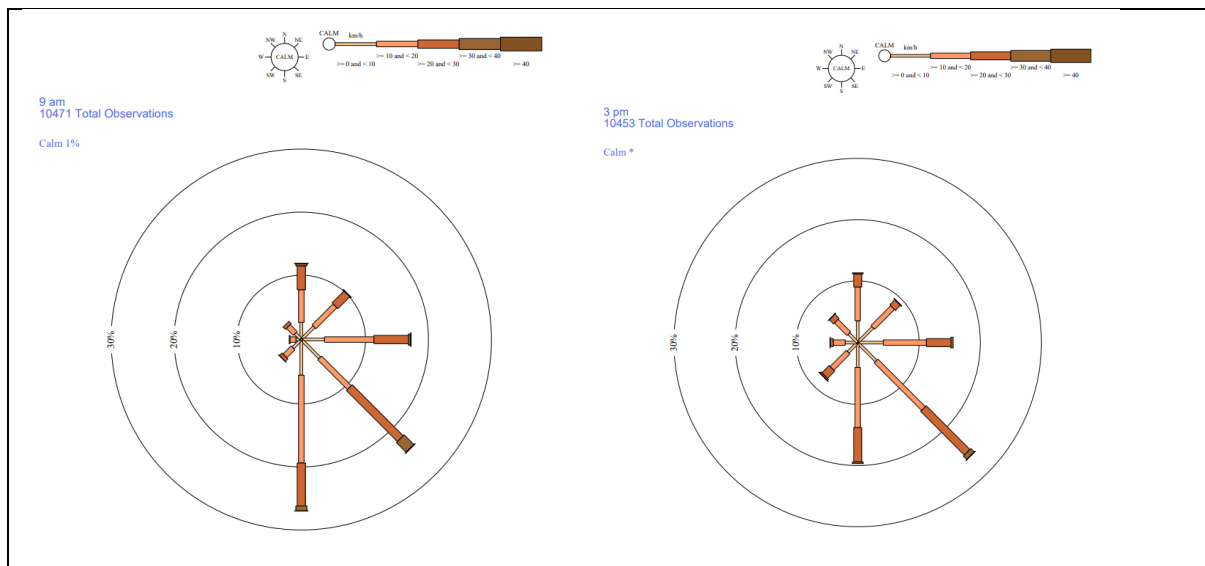


Figure 3. Monthly Mean Rainfall for the Cloncurry Airport (BOM 2023)

**Table 5. Rainfall Statistics for the Cloncurry Airport Adapted from BOM 2023**

Statistic	Jan	Feb	Mar	Apr	May	Jun	Jul	Aug	Sep	Oct	Nov	Dec	Annual
Mean rainfall (mm)	154.8	103.4	73.7	16.0	7.6	7.8	4.3	4.1	6.9	18.8	35.8	75.1	501.1
Days $\geq$ 1mm	8.3	6.2	4.2	1.4	0.8	0.7	0.5	0.4	1.2	2.0	3.8	5.4	34.9



**Figure 4. Cloncurry Airport 9am and 3pm Wind Rose (BOM 2022)**

### 3.1.10.1.2. Long-term Climate Projections

The 2020 State of the Climate Report (Commonwealth Scientific and Industrial Research Organisation and Bureau of Meteorology, 2020) has predicted a continued decrease in cool season rainfall across Eastern Australia, leading to prolonged periods of drought. Air temperature will continue to rise with increased occurrence of extreme heat days. Collectively, these two factors will increase bushfire risk indicated by the change in dangerous fire weather days. More intense short duration heavy rainfall events are predicted across the country, increasing flood risk in some areas.

### 3.1.10.2. Topography and Hydrology

#### 3.1.10.2.1. Topography

The topography of the DRM is dominated by the Knapdale Range (Knapdales) as the topographical high (~310mAHD). The Knapdales is a north south orientated formation ~14km long and ~2.5km wide sharply transitioning to undulating country east to the Dugald River and west to Cabbage Tree Creek at ~200mAHD (Figure 5)

The mining and processing infrastructure is located on the eastern slope of the Knapdale Range with the Tailings Storage Facility sited within the centre valley of the range, formerly draining to the west.

#### 3.1.10.2.2. Hydrology

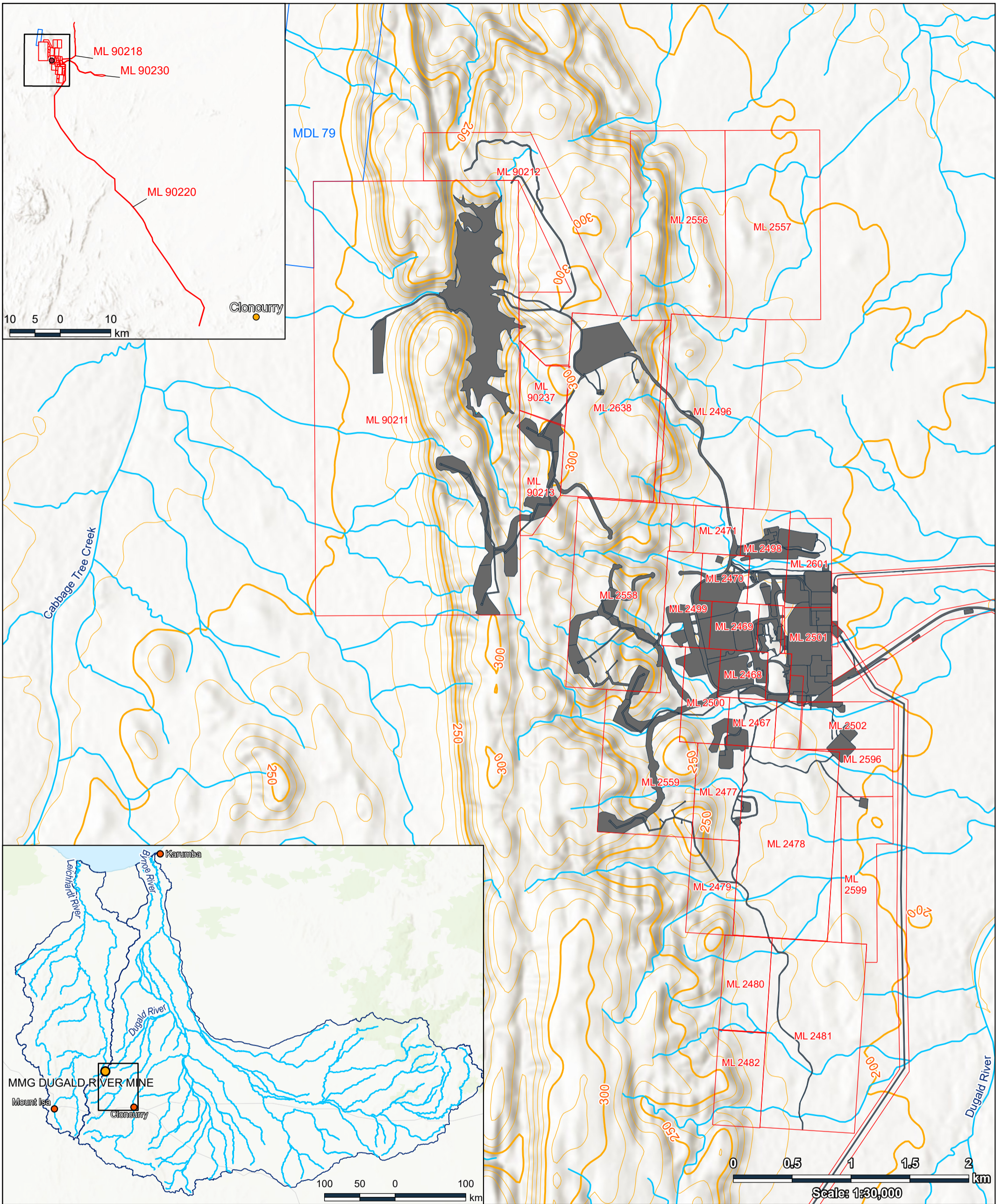
Regionally, DRM is situated in the Leichardt and Flinders drainage basins with the Knapdale Range providing the drainage divide between the two catchments (WRM, 2010). Both the Leichardt and Flinders Rivers drain north into the Gulf of Carpentaria ~400 km from the Project (Figure 5).

Locally, the Project area is dominated by stream order 1 and 2 ephemeral drainage features that only flow intermittently during wet season rains. To the north and west of the Knapdales, these features drain to Vieux Rose Creek and Cabbage Tree Creek which flow into Pinnacle Creek, a tributary of the Leichardt River. Drainage to the east and south of the Knapdales enters the Flinders River via Dugald River, a tributary of the Cloncurry River (Wulguru Technical Services, 2021). The catchments associated with the predominant mine features are listed in Table 6.

**Table 6. Local Catchments and Their Mine Features**

Local catchment	Mine features
Silvermine Creek	Mining, processing, mineral waste storage, administration, mine access, village, and logistics
Vieux Rose Creek	Village
Cabbage Tree Creek	Tailings storage facility





**Figure 5. Topography and Hydrology**

Client: MMG Dugald River Pty Ltd  
 Project Number: 2023.03002  
 Publication Date: 1/12/2023

Spatial Reference  
 PCS: GDA2020 MGA Zone 54  
 GCS: GDA2020  
 Datum: GDA2020

Print on A3

**Legend**

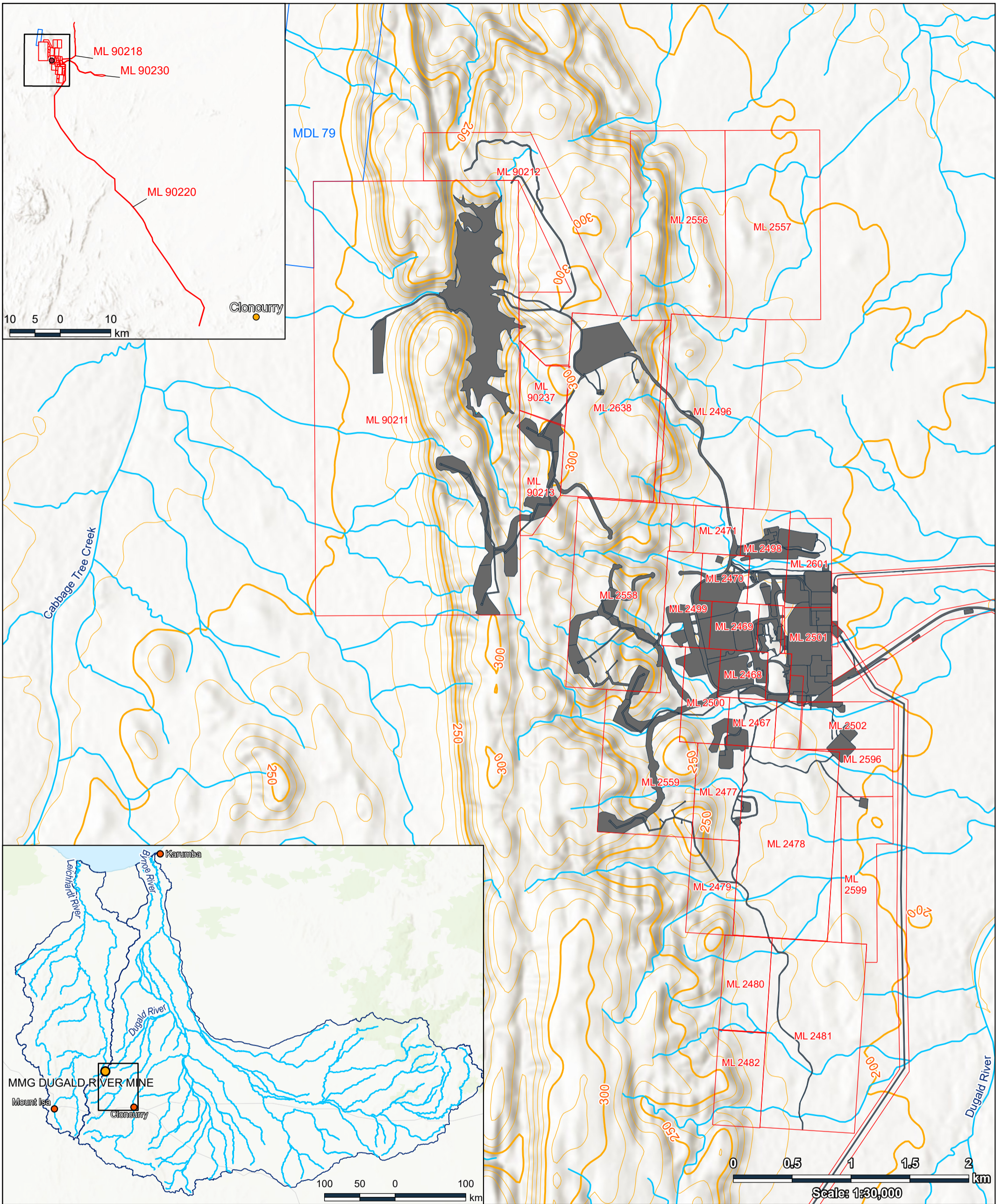
- Mining Lease
- Mineral Development License
- Footprint
- Contour (50m)
- Contour (10m)
- Watercourse

**Disclaimer:**  
 Whilst every effort and care has been taken to ensure the accuracy of this report, Wulguru Technical Services Pty Ltd makes no representations or warranties about its accuracy, reliability, completeness or suitability for any particular purpose and disclaims all responsibility and all liability (including without limitation, liability in negligence) for all expenses, losses, damages (including indirect or consequential damage) and costs which you might incur as a result of the product being inaccurate or incomplete in any way and for any reason. Digital data for this report is available on the Queensland Government Spatial Portal at <https://qldspatial.information.qld.gov.au>.



**WULGURU TECHNICAL SERVICES**





**Figure 5. Topography and Hydrology**

Client: MMG Dugald River Pty Ltd  
 Project Number: 2023.03002  
 Publication Date: 1/12/2023

Spatial Reference  
 PCS: GDA2020 MGA Zone 54  
 GCS: GDA2020  
 Datum: GDA2020

Print on A3

**Legend**

- Mining Lease
- Mineral Development License
- Footprint
- Contour (50m)
- Contour (10m)
- Watercourse

Disclaimer:  
 Whilst every effort and care has been taken to ensure the accuracy of this report, Wulguru Technical Services Pty Ltd makes no representations or warranties about its accuracy, reliability, completeness or suitability for any particular purpose and disclaims all responsibility and all liability (including without limitation, liability in negligence) for all expenses, losses, damages (including indirect or consequential damage) and costs which you might incur as a result of the product being inaccurate or incomplete in any way and for any reason. Digital data for this report is available on the Queensland Government Spatial Portal at <https://qldspatial.information.qld.gov.au>.



**WULGURU TECHNICAL SERVICES**



### **3.1.10.3. Surface Water**

#### **3.1.10.3.1. Environmental Values**

The Environmental Protection Policy (Water and Wetland Biodiversity) (EPP Water) details the scheduled water quality basins and their specific management intent. DRM is situated between the Leichardt and Flinders drainage basins with the Knapdale Range providing the drainage divide between the two catchments. No Environmental Values are listed in the EPP Water for either the Leichardt or Flinders drainage basins. In the absence of EVs for either catchment, the following EVs have been adopted from the EPP Water Part 3:

- For high ecological value waters—the biological integrity of an aquatic ecosystem that is effectively unmodified or highly valued; or
- For slightly disturbed waters—the biological integrity of an aquatic ecosystem that has effectively unmodified biological indicators, but slightly modified physical, chemical or other indicators; or
- For moderately disturbed waters—the biological integrity of an aquatic ecosystem that is adversely affected by human activity to a relatively small but measurable degree; or
- For highly disturbed waters—the biological integrity of an aquatic ecosystem that is measurably degraded and of lower ecological value than waters mentioned in paragraphs (a) to (c); or
- For waters from which aquatic foods intended for human consumption are taken—the suitability of the water for producing the foods for human consumption; or
- For waters that may be used for aquaculture—the suitability of the water for aquacultural use; or
- For waters that may be used for agricultural purposes—the suitability of the water for agricultural purposes; or
- For waters that may be used for recreation or aesthetic purposes—the suitability of the water for—
  - Primary recreational use; or
  - Secondary recreational use; or
  - Visual recreational use; or
- For waters that may be used for drinking water—the suitability of the water for supply as drinking water having regard to the level of treatment of the water; or
- For waters that may be used for industrial purposes—the suitability of the water for industrial use; or
- The cultural and spiritual values of the water (EPP Water, 2019).



### 3.1.10.3.2. Water Quality Trigger Limits

The EA provides receiving water reference sites and downstream monitoring locations (Schedule C – Table 4 of the EA) (Figure 6). Each site is monitored and sampled in accordance with Schedule C Table 5 of the EA, presented below in Table 7.

**Table 7 Receiving Waters Trigger Levels and Contaminant Limits (Schedule C - Table 5 of the EA)**

Quality Characteristic	Unit	Trigger Level	Contaminant Limit	Monitoring Frequency
Hardness (CaCO <sub>3</sub> )	mg/L	For interpretation purposes		<p><u>Sites on tributaries of Dugald River:</u></p> <p>Sample daily for the first two days when releases or stream flows commence at interpretative sites. If releases or flows at interpretative sites persist, sample weekly until flow ceases.</p> <p><u>Dugald River Sites:</u></p> <p>Sample Dugald River sites daily while there is flows at DR-14, and daily for one week after cessation of flows at SC-38 and SN-23.</p> <p>Sample monthly if flows are present in Dugald River during the wet season.</p> <p><u>Cabbage Tree Creek sites:</u></p> <p>Sample CT3-08, CC-05 and CC-15 daily when flows are present at CT3-08 and sample CC-05 and CC-15 daily for two days after flows at CT3-08 cease.</p>
pH	pH Units	6.0 (minimum) 8.6 (maximum)	5.5 (minimum) 9.0 (maximum)	
Electrical Conductivity	µS/cm	435 or 80 <sup>th</sup> percentile of reference whichever is higher	1000	
Total Suspended Solids	mg/L	For interpretation purposes		
Sulfate	mg/L	77 <sup>[Dugald River]</sup> or 80 <sup>th</sup> percentile of reference whichever is higher	400	
Fluoride	mg/L	80 <sup>th</sup> percentile of reference	2 or 95 <sup>th</sup> percentile of reference whichever is lower	
Aluminium (dissolved)	mg/L	0.055	0.8	
Aluminium (total)	mg/L	For interpretation purposes		
Arsenic (dissolved)	mg/L	0.013 or 80 <sup>th</sup> percentile of reference whichever is higher	95 <sup>th</sup> percentile of reference	
Arsenic (total)	mg/L	-	0.5	

Quality Characteristic	Unit	Trigger Level	Contaminant Limit	Monitoring Frequency
Cadmium (dissolved)	mg/L	0.0002 or 80 <sup>th</sup> percentile of reference whichever is higher	95 <sup>th</sup> percentile of reference	Sample CC-05 and CC-15 weekly if flows are present.
Cadmium (total)	mg/L	-	0.005	
Copper (dissolved)	mg/L	0.0014 or 80 <sup>th</sup> percentile of reference whichever is higher	95 <sup>th</sup> percentile of reference	
Copper (total)	mg/L	-	1	
Lead (dissolved)	mg/L	0.0034 or 80 <sup>th</sup> percentile of reference whichever is higher	95 <sup>th</sup> percentile of reference	
Lead (total)	mg/L	-	0.05	
Manganese (dissolved)	mg/L	1.9 or 80 <sup>th</sup> percentile of reference whichever is higher	95 <sup>th</sup> percentile of reference	
Manganese (total)	mg/L	For interpretation purposes		
Nickel (dissolved)	mg/L	0.011 or 80 <sup>th</sup> percentile of reference whichever is higher	95 <sup>th</sup> percentile of reference	
Nickel (total)	mg/L	-	1	
Zinc (dissolved)	mg/L	0.008 or 80 <sup>th</sup> percentile of reference whichever is higher	95 <sup>th</sup> percentile of reference	
Zinc (total)	mg/L	-	20	

#### **3.1.10.3.3. Receiving Environment Monitoring Program**

DRM implements a receiving environment monitoring program (REMP), that encompasses event-based surface water sampling, stream sediment sampling and macroinvertebrate and fish sampling.

REMP data collected to date indicates that the ephemeral sites on Silvermine Creek and Cabbage Tree Creek provide limited habitat opportunities for most aquatic organisms. Waterholes dry out too quickly to allow the establishment of sustained aquatic plant, macroinvertebrate or freshwater fish communities (TropWater, 2020). The ephemeral waterholes are also too small and transient to have recreational value or provide watering points for terrestrial fauna.

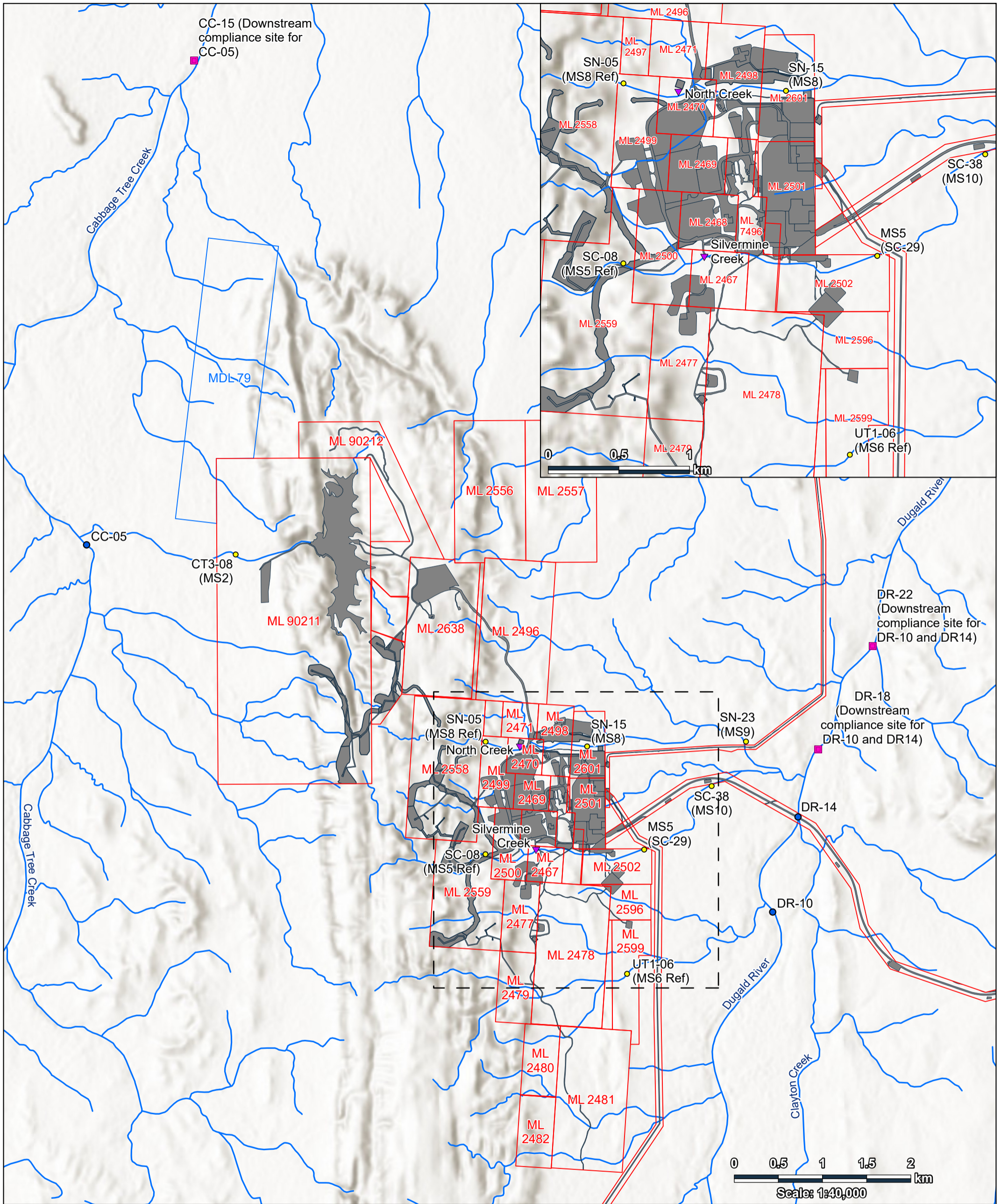
The waterholes that form along the main channel of Dugald River are larger and semi-permanent. The waterholes periodically provide refugia for freshwater biological communities and provide a drinking water source for livestock and terrestrial fauna.

Overall, the waterholes assessed in the REMP are defined as being slightly to moderately disturbed, typical of waterways in free grazing areas (TropWater, 2020).

#### **3.1.10.3.4. Surface Water Quality**

A summary of surface water chemistry is provided in Table 8.





**Figure 6. Surface Water Monitoring**

Client: MMG Dugald River Pty Ltd  
 Project Number: 2023.03002  
 Publication Date: 24/11/2023

Spatial Reference  
 PCS: GDA2020 MGA Zone 54  
 GCS: GDA2020  
 Datum: GDA2020

Print on A3

**Legend**

- Mining Lease
- Mineral Development License
- Existing Disturbance
- Watercourse (VM Act)

**SW Monitoring Type**

- Reference
- Downstream
- Interpretation
- ▼ Gauging

Disclaimer:  
 Whilst every effort and care has been taken to ensure the accuracy of this report, Wulguru Technical Services Pty Ltd makes no representations or warranties about its accuracy, reliability, completeness or suitability for any particular purpose and disclaims all responsibility and all liability (including without limitation, liability in negligence) for all expenses, losses, damages (including indirect or consequential damage) and costs which you might incur as a result of the product being inaccurate or incomplete in any way and for any reason. Digital data for this report is available on the Queensland Government Spatial Portal at <https://qldspatial.information.qld.gov.au>.





Table 9 Surface Water Chemistry (2020-2022)

		Hardness (mg/l)	pH	EC µS/cm	TSS (mg/l)	Sulphate (mg/l)	Fluoride (mg/l)	Total Metals (mg/l)						Filtered Metals (mg/l)										
								Al	As	Cd	Cu	Pb	Mn	Ni	Zn	Al	As	Cd	Cu	Pb	Mn	Ni	Zn	
SC-08	Count	20																						
	Minimum	0.50	6.21	28.00	2.50	0.50	<0.1	0.04	<0.001	<0.0001	0.0005	<0.001	0.0020	<0.001	0.0025	0.0400	0.0005	0.0001	0.0005	0.0005	0.0005	0.0005	0.0005	0.0025
	Maximum	13.00	7.29	73.00	11.00	3.00	<0.1	1.64	<0.001	<0.0001	0.0030	<0.001	0.0550	<0.001	0.0060	0.3900	0.0020	0.0003	0.0030	0.0010	0.0560	0.0010	0.0070	
	Mean	9.00	6.63	48.15	3.45	1.73	<0.1	0.37	<0.001	<0.0001	0.0012	<0.001	0.0100	<0.001	0.0030	0.1475	0.0006	0.0001	0.0008	0.0006	0.0076	0.0005	0.0027	
	Median	11.00	6.65	47.00	2.50	2.00	<0.1	0.18	<0.001	<0.0001	0.0008	<0.001	0.0055	<0.001	0.0025	0.1100	0.0005	0.0001	0.0005	0.0005	0.0035	0.0005	0.0025	
SN-05	Count	10																						
	Minimum	0.50	6.27	32.00	<5	2.00	<0.1	0.04	<0.001	<0.0001	0.0005	0.0005	0.0020	<0.001	0.0025	0.0400	<0.001	<0.0001	<0.001	<0.001	0.0020	<0.001	0.0025	
	Maximum	13.00	7.06	70.00	<5	7.00	<0.1	0.48	<0.001	<0.0001	0.0010	0.0020	0.0160	<0.001	0.0150	0.2700	<0.001	<0.0001	<0.001	<0.001	0.0150	<0.001	0.0140	
	Mean	8.40	6.70	50.50	<5	2.70	<0.1	0.16	<0.001	<0.0001	0.0006	0.0008	0.0061	<0.001	0.0081	0.1040	<0.001	<0.0001	<0.001	<0.001	0.0052	<0.001	0.0062	
	Median	10.0	6.70	51.00	<5	2.00	<0.1	0.09	<0.001	<0.0001	0.0005	0.0005	0.0035	<0.001	0.0070	0.0650	<0.001	<0.0001	<0.001	<0.001	0.0030	<0.001	0.0060	
CT3-08	Count	2																						
	Minimum	69.00	7.07	203.00	<5	3.00	0.20	0.13	<0.001	<0.0001	0.0010	<0.001	0.0160	<0.001	0.0025	0.0600	<0.001	<0.0001	0.001	<0.001	0.0180	<0.001	<0.005	
	Maximum	115.00	7.95	331.00	<5	120.00	0.20	0.27	<0.001	<0.0001	0.0020	<0.001	0.0380	<0.001	0.0050	0.0700	<0.001	<0.0001	0.001	<0.001	0.0220	<0.001	<0.005	
	Mean	92.00	7.51	267.00	<5	61.50	0.20	0.20	<0.001	<0.0001	0.0015	<0.001	0.0270	<0.001	0.0038	0.0650	<0.001	<0.0001	0.001	<0.001	0.0200	<0.001	<0.005	
	Median	92.00	7.51	267.00	<5	61.50	0.20	0.20	<0.001	<0.0001	0.0015	<0.001	0.0270	<0.001	0.0038	0.0650	<0.001	<0.0001	0.001	<0.001	0.0200	<0.001	<0.005	
MS5	Count	15																						
	Minimum	7.00	6.56	39.00	2.50	1.00	<0.1	0.09	0.0005	0.0001	0.0010	0.0005	0.0080	0.0005	0.0025	0.0600	0.0005	0.0001	0.0005	0.0005	0.0005	0.0005	0.0005	0.0025
	Maximum	45.00	7.66	126.00	107.00	20.00	<0.1	3.96	0.0040	0.0003	0.0360	0.0430	0.2030	0.0050	0.1590	0.6400	0.0020	0.0002	0.0110	0.0050	0.1490	0.0010	0.0350	
	Mean	27.60	6.99	88.20	19.23	10.00	<0.1	0.94	0.0013	0.0001	0.0079	0.0084	0.0542	0.0014	0.0438	0.2636	0.0007	0.0001	0.0032	0.0017	0.0316	0.0005	0.0149	
	Median	28.00	6.97	89.00	5.00	11.00	<0.1	0.49	0.0010	0.0001	0.0030	0.0040	0.0280	0.0005	0.0280	0.2100	0.0005	0.0001	0.0020	0.0010	0.0160	0.0005	0.0120	
UT1-06	Count	12			13																			
	Minimum	9.00	6.43	39.00	2.50	0.50	0.05	0.06	<0.001	<0.0001	0.0005	<0.001	0.0020	0.0005	0.0025	0.0400	0.0005	<0.0001	0.0010	0.0005	0.0010	<0.001	<0.005	
	Maximum	32.00	7.72	103.00	21.00	2.00	0.20	0.75	<0.001	<0.0001	0.0080	<0.001	0.0770	0.0010	0.0060	0.5000	0.0010	<0.0001	0.0060	0.0010	0.0700	<0.001	<0.005	
	Mean	17.33	7.02	61.83	4.92	0.92	0.06	0.30	<0.001	<0.0001	0.0037	<0.001	0.0145	0.0005	0.0028	0.2200	0.0006	<0.0001	0.0028	0.0005	0.0111	<0.001	<0.005	
	Median	17.00	7.04	56.50	2.50	1.00	0.05	0.19	<0.001	<0.0001	0.0030	<0.001	0.0070	0.0005	0.0025	0.2000	0.0005	<0.0001	0.0020	0.0005	0.0060	<0.001	<0.005	
SN-15	Count	8.00																						
	Minimum	23.00	7.07	71.00	2.50	5.00	<0.1	0.04	<0.001	0.0001	0.0005	0.0040	0.0040	0.0005	0.0210	0.0200	<0.001	0.0001	0.0005	0.0020	0.0030	<0.001	0.0140	
	Maximum	51.00	7.76	132.00	6.00	22.00	<0.1	0.50	<0.001	0.0003	0.0010	0.0140	0.0420	0.0005	0.1120	0.2000	<0.001	0.0001	0.0010	0.0070	0.0290	<0.001	0.0620	
	Mean	34.00	7.33	101.00	2.94	9.75	<0.1	0.14	<0.001	0.0001	0.0006	0.0071	0.0131	0.0005	0.0445	0.0713	<0.001	0.0001	0.0008	0.0041	0.0100	<0.001	0.0271	
	Median	35.00	7.26	102.00	2.50	7.00	<0.1	0.07	<0.001	0.0001	0.0005	0.0060	0.0095	0.0005	0.0245	0.0400	<0.001	0.0001	0.0010	0.0040	0.0080	<0.001	0.0235	
SN-23	Count	15																						
	Minimum	17.00	6.47	48.00	2.50	2.00	0.05	0.02	<0.1	0.0001	0.0020	0.0005	0.0160	0.0005	0.0025	0.0100	<0.001	<0.0001	0.0020	0.0005	0.0050	<0.001	0.0025	
	Maximum	73.00	8.28	179.00	30.00	32.00	0.10	1.28	<0.1	0.0002	0.0140	0.0350	0.1180	0.0010	0.1020	0.2900	<0.001	<0.0001	0.0090	0.0110	0.1000	<0.001	0.0130	
	Mean	44.47	7.18	114.27	11.77	10.33	0.05	0.45	<0.1	0.0001	0.0063	0.0054	0.0454	0.0006	0.0178	0.1423	<0.001	<0.0001	0.0033	0.0018	0.0343	<0.001	0.0049	
	Median	50.00	7.18	128.00	6.00	7.00	0.05	0.32	<0.1	0.0001	0.0050	0.0040	0.0320	0.0005	0.0100	0.1100	<0.001	<0.0001	0.0020	0.0010	0.0240	<0.001	0.0025	
SC-38	Count	14																						
	Minimum	7.00	6.57	39.00	2.50	0.50	0.05	0.08	0.0005	0.0001	0.0010	0.0005	0.0060	0.0005	0.0025	0.0400	0.0005	<0.0001	0.0005	0.0005	0.0005	<0.001	0.0025	
	Maximum	42.00	7.72	115.00	88.00	16.00	0.10	3.22	0.0040	0.0001	0.0280	0.0180	0.2190	0.0040	0.0770	0.7200	0.0020	<0.0001	0.0100	0.0050	0.1570	<0.001	0.0230	
	Mean	29.50	7.08	89.07	13.00	8.96	0.05	0.65	0.0010	0.0001	0.0061	0.0051	0.0400	0.0009	0.0249	0.2343	0.0007	<0.0001	0.0033	0.0015	0.0273	<0.001	0.0086	

		Hardness (mg/l)	pH	EC µS/cm	TSS (mg/l)	Sulphate (mg/l)	Fluoride (mg/l)	Total Metals (mg/l)							Filtered Metals (mg/l)								
								Al	As	Cd	Cu	Pb	Mn	Ni	Zn	Al	As	Cd	Cu	Pb	Mn	Ni	Zn
	Median	31.00	7.08	92.00	2.50	8.00	0.05	0.46	0.0005	0.0001	0.0030	0.0020	0.0210	0.0005	0.0115	0.1600	0.0005	<0.0001	0.0020	0.0005	0.0145	<0.001	0.0065
DR-10	Count	58	59			56	59									43	59						
	Minimum	0.50	5.89	1.00	2.50	0.50	0.05	0.01	0.0005	0.0001	0.0005	0.0005	0.0005	0.0005	0.0003	0.0050	0.0003	<0.0001	0.0005	0.0001	0.0005	0.0005	0.0014
	Maximum	108.00	8.23	296.00	702.00	6.00	0.24	38.40	0.0050	0.0002	0.1090	0.0220	1.8200	0.0390	0.2070	0.5700	0.0005	<0.0001	0.0060	0.0050	0.0460	0.0190	0.0310
	Mean	52.13	7.47	143.75	68.12	2.46	0.12	3.86	0.0008	0.0001	0.0105	0.0022	0.1505	0.0037	0.0112	0.2161	0.0005	<0.0001	0.0021	0.0006	0.0073	0.0010	0.0030
	Median	52.00	7.49	138.00	16.00	2.00	0.10	1.93	0.0005	0.0001	0.0060	0.0005	0.0840	0.0020	0.0025	0.1900	0.0005	<0.0001	0.0020	0.0005	0.0050	0.0005	0.0025
DR-14	Count	63	64			62	64																
	Minimum	10.00	6.72	37.00	2.50	0.15	0.05	0.20	0.0005	0.0001	0.0020	0.0005	0.0470	0.0005	0.0025	0.0025	0.0005	<0.0001	0.0010	0.0001	0.0005	0.0005	0.0025
	Maximum	129.00	8.26	298.00	654.00	21.00	0.21	41.90	0.0040	0.0007	0.1210	0.0180	1.9900	0.0430	0.0900	0.5500	0.0010	<0.0001	0.0060	0.0030	0.1370	0.0190	0.0130
	Mean	51.71	7.48	143.52	72.70	2.59	0.12	3.86	0.0008	0.0001	0.0103	0.0021	0.1856	0.0037	0.0079	0.1680	0.0005	<0.0001	0.0021	0.0005	0.0157	0.0008	0.0028
	Median	50.00	7.54	136.50	18.00	2.00	0.10	1.83	0.0005	0.0001	0.0060	0.0005	0.1115	0.0020	0.0025	0.1450	0.0005	<0.0001	0.0020	0.0005	0.0100	0.0005	0.0025
CC-05	Count	8																					
	Minimum	28.00	6.92	80.00	2.50	0.50	0.05	0.08	0.0005	<0.0001	0.0020	0.0005	0.0420	0.0005	0.0025	0.0300	<0.001	<0.0001	0.0010	<0.001	0.0070	<0.001	0.0025
	Maximum	95.00	8.19	223.00	108.00	4.00	0.20	3.97	0.0010	<0.0001	0.0080	0.0020	0.2260	0.0130	0.0300	0.3700	<0.001	<0.0001	0.0030	<0.001	0.0300	<0.001	0.0080
	Mean	56.25	7.65	145.50	34.56	1.75	0.15	1.65	0.0006	<0.0001	0.0045	0.0009	0.0820	0.0034	0.0065	0.1913	<0.001	<0.0001	0.0020	<0.001	0.0196	<0.001	0.0032
	Median	51.50	7.81	144.00	14.00	1.25	0.20	0.90	0.0005	<0.0001	0.0030	0.0005	0.0630	0.0025	0.0025	0.1800	<0.001	<0.0001	0.0020	<0.001	0.0210	<0.001	0.0025
DR-18	Count	64	65			63	65																
	Minimum	15.00	6.64	58.00	2.50	0.15	0.05	0.16	0.0005	<0.0001	0.0020	0.0003	0.0600	0.0005	0.0025	0.0025	0.0005	<0.0001	0.0005	0.0001	0.0005	0.0005	0.0025
	Maximum	186.00	8.48	1520.00	638.00	51.00	1.20	25.80	0.0050	<0.0001	0.0520	0.0260	0.9320	0.0170	0.2120	0.5400	0.0020	<0.0001	0.0040	0.0005	0.4700	0.0020	0.0420
	Mean	54.89	7.52	166.91	75.92	3.27	0.14	3.39	0.0009	<0.0001	0.0090	0.0020	0.1882	0.0033	0.0105	0.1521	0.0005	<0.0001	0.0021	0.0005	0.0287	0.0006	0.0035
	Median	54.00	7.64	141.00	30.00	2.00	0.10	1.74	0.0005	<0.0001	0.0060	0.0005	0.1200	0.0020	0.0025	0.1100	0.0005	<0.0001	0.0020	0.0005	0.0160	0.0005	0.0025
DR-22	Count	65.00	66.00			63.00	66.00																
	Minimum	19.00	6.64	58.00	2.50	0.15	0.05	0.32	0.0005	<0.0001	0.0030	0.0005	0.0590	0.0005	0.0025	0.0025	0.0005	0.0001	0.0005	0.0001	0.0005	0.0005	0.0005
	Maximum	190.00	8.14	833.00	435.00	8.00	0.50	16.10	0.0030	<0.0001	0.0450	0.0200	1.5300	0.0160	0.0650	0.5100	0.0020	0.0002	0.0040	0.0005	1.3400	0.0040	0.0260
	Mean	47.78	7.40	138.56	56.80	2.01	0.12	3.05	0.0008	<0.0001	0.0084	0.0021	0.1755	0.0032	0.0072	0.1643	0.0005	0.0001	0.0021	0.0005	0.0310	0.0006	0.0030
	Median	46.00	7.41	120.50	21.50	2.00	0.10	1.92	0.0005	<0.0001	0.0060	0.0010	0.1025	0.0020	0.0025	0.1300	0.0005	0.0001	0.0020	0.0005	0.0060	0.0005	0.0025
CC-15	Count	11.00																					
	Minimum	24.00	6.95	72.00	2.50	0.50	0.05	0.01	<0.001	<0.0001	0.0005	0.0005	0.0470	0.0005	0.0025	0.0050	<0.001	<0.0001	0.0005	0.0005	0.0140	0.0005	<0.005
	Maximum	179.00	8.07	507.00	94.00	10.00	0.30	3.31	<0.001	<0.0001	0.0080	0.0020	0.5840	0.0170	0.0070	0.3800	<0.001	<0.0001	0.0030	0.0005	0.5370	0.0010	<0.005
	Mean	87.82	7.75	236.18	22.32	3.14	0.17	1.06	<0.001	<0.0001	0.0037	0.0007	0.1663	0.0028	0.0031	0.1350	<0.001	<0.0001	0.0016	0.0005	0.1262	0.0005	<0.005
	Median	71.00	7.98	196.00	12.00	2.00	0.20	0.44	<0.001	<0.0001	0.0020	0.0005	0.0800	0.0005	0.0025	0.0700	<0.001	<0.0001	0.0020	0.0005	0.0320	0.0005	<0.005

### **3.1.10.4. Groundwaters**

#### **3.1.10.4.1. Environmental Values**

The most relevant EVs were derived from the EPP (Water and Wetland Biodiversity) 2019 which include:

- For waters that may be used for agricultural purposes – the suitability of the water for agricultural purposes;
- For waters that may be used for recreation or aesthetic purposes – the suitability of water for:
  - Primary recreational use; or
  - Secondary recreational use; or
  - Visual recreational use
- For water that may be used for drinking water – the suitability of the water for supply as drinking water having regard to the level of treatment of the water;
- For waters that may be used for industrial purposes – the suitability of the water for industrial use; or
- The cultural and spiritual values of the waters.

#### **3.1.10.4.2. Groundwater Monitoring Network**

The groundwater monitoring network is described in Table 10 and in Figure 7. The groundwater monitoring program focusses on risk associated with the mine infrastructure area. Several bores are located to the west of the Knapdale Range (MB5, MB6, MB9S and MB9D) to monitor for potential impacts from the TSF.

**Table 10. Groundwater Bore Details**

Bore	Formation	EA classification	Permeability
MB1	Mount Roseby Schist	Background	$7.53 \times 10^{-6}$
MB3	Mount Roseby Schist	Background	$2.60 \times 10^{-1}$
MB5	Mount Roseby Schist	Compliance	$9.21 \times 10^{-2}$
MB6	Mount Roseby Schist	Compliance	$2.23 \times 10^{-3}$
MB9S	Knapdale Quartzite	Compliance	No data
MB9D	Knapdale Quartzite	Compliance	No data
MB2	Mount Roseby Schist	Compliance	$4.08 \times 10^{-1}$
MB4	Mount Roseby Schist	Compliance	$7.52 \times 10^{-2}$
GWBFAB	Dugald River Slate	Interpretation	No data
MB1AB	Mount Roseby Schist	Interpretation	No data
MB2AB	Mount Roseby Schist	Interpretation	No data
MB3AB	Mount Roseby Schist	Interpretation	No data
MB4AB	Mount Roseby Schist	Interpretation	No data
SHALL6AB	Mount Roseby Schist	Interpretation	No data

#### 3.1.10.4.3. Groundwater Trigger Limits

Schedule C Table 36 specifies the groundwater quality trigger Limits for DRM. Trigger limits are detailed in Table 11.



**Table 11. Groundwater Trigger Levels and Contaminant Limits (EPML00731213)**

Quality Characteristic <sup>1</sup>	Unit	Trigger Level <sup>[1]</sup>	Contaminant limit <sup>[2]</sup>
pH	pH unit	6.0 (minimum) 8.0 (maximum)	6.0 (minimum) 9.0 (maximum)
Electrical Conductivity	µS/cm	1500 <sup>[6]</sup>	2000 <sup>[6]</sup>
Hardness (as CaCO <sub>3</sub> )	mg/L	For interpretation purposes	
Total Dissolved Solids (TDS)	mg/L	For interpretation purposes	
Major ions	mg/L	For interpretation purposes	
Sulphate (mg/L)	mg/L	150 <sup>[6]</sup>	1000 <sup>[5]</sup>
Fluoride (mg/L)	mg/L	-	2 <sup>[4]</sup>
Aluminium	mg/L	0.055 <sup>[3]</sup>	5 <sup>[4]</sup>
Arsenic <sup>[7]</sup>	mg/L	0.013 <sup>[3]</sup>	0.5 <sup>[4]</sup>
Cadmium (mg/L)	mg/L	0.0002 <sup>[3]</sup>	0.01 <sup>[4]</sup>
Copper (mg/L)	mg/L	0.0014 <sup>[3]</sup>	1 <sup>[4]</sup>
Lead (mg/L)	mg/L	0.0034 <sup>[3]</sup>	0.1 <sup>[4]</sup>
Manganese (mg/L)	mg/L	1.9 <sup>[3]</sup>	-
Nickel (mg/L)	mg/L	0.011 <sup>[3]</sup>	1 <sup>[4]</sup>
Zinc (mg/L)	mg/L	0.008 <sup>[3]</sup>	20 <sup>[4]</sup>

[1] All metals and metalloids must be measured as filtered with the exception of fluoride.

[2] All metals and metalloids must be measured as total (unfiltered).

[3] Based on ANZECC/ARMCANZ (2000) Table 3.4.1 (high reliability trigger values) and Section 8.3 moderate or low reliability trigger values if no value available in Table 3.4.1.

[4] Based on ANZECC/ARMCANZ (2000) Table 4.3.2 for livestock drinking water.

[5] Based on ANZECC/ARMCANZ (2000) Section 4.3.3.4;

[6] MMG Dugald River - site specific value

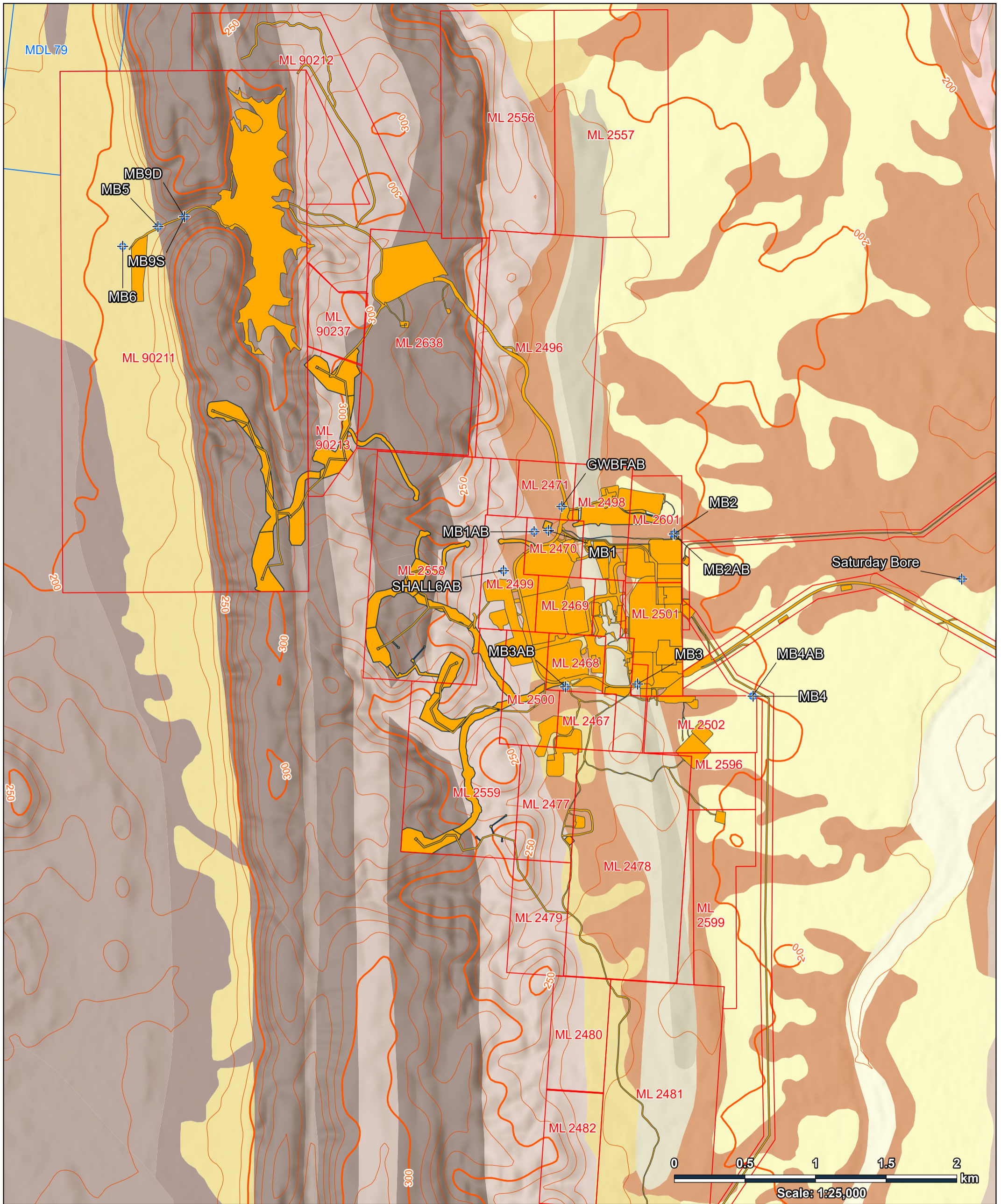
[7] Speciated arsenic concentrations for As (III) and As (V) only required if 13 mg/L is exceeded - note that the sample bottle requirements for As (total species) and As (speciated) may differ.

#### 3.1.10.4.4. Groundwater Quality

CDM Smith (2021) completed the most recent biennial review of the groundwater monitoring program. The review refers to the ionic composition as being bicarbonate dominant across the bores except for MB3 which is sulfate dominant, and the water quality is described as suitable for stock watering and marginally potable at some locations. CDM Smith (2021) summarised the compliance assessment for the Project as:

- Most analytes were below trigger levels, HMTVs or below background levels. Copper at MB2 should be assessed using control charting if exceedances of the HMTV are noted in future; and
- Most analytes were below contaminant limits with the exception of fluoride at MB2 (within natural variation) and aluminium at MB9D (potentially due to high suspended sediment in the bore).





Client: MMG Dugald River Pty Ltd  
 Project Number: 2023.03002  
 Publication Date: 24/11/2023

Spatial Reference  
 PCS: GDA2020 MGA Zone 54  
 GCS: GDA2020  
 Datum: GDA2020

Print on A3

**Legend**

- Mining Lease
- Mineral Development License
- Existing Disturbance
- Contour (50m)
- Contour (10m)
- + Monitoring Bore

**Surface Geology**

- Coocerina Formation (PLpc)
- Corella Formation-c (PLkc-c)
- Dugald River Shale Member (PLpod)
- Dugald River Shale Member/l (PLpod/l)

- Knapdale Quartzite (PLpk)
- Knapdale Quartzite/c (PLpk/c)
- Knapdale Quartzite/q (PLpk/q)
- Knapdale Quartzite/t (PLpk/t)
- Lady Clayre Formation/d (PLpy/d)

- Lady Clayre Formation/s (PLpy/s)
- Mount Roseby Schist (PLpo)
- Qa-QLD (Qa)
- TQa-QLD (TQa)
- TQf-QLD (TQf)
- q-MI (q)

**Figure 7. Ground Water Monitoring and Surface Geology**

**Disclaimer:**  
 Whilst every effort and care has been taken to ensure the accuracy of this report, Wulguru Technical Services Pty Ltd makes no representations or warranties about its accuracy, reliability, completeness or suitability for any particular purpose and disclaims all responsibility and all liability (including without limitation, liability in negligence) for all expenses, losses, damages (including indirect or consequential damage) and costs which you might incur as a result of the product being inaccurate or incomplete in any way and for any reason. Digital data for this report is available on the Queensland Government Spatial Portal at <https://qldspatial.information.qld.gov.au>.





Table 12. Groundwater Chemistry (2009-2022)

		SWL (m)	Hardness (mg/l)	pH	EC µS/cm	TSS (mg/l)	Sulphate (mg/l)	Fluoride (mg/l)	Total Metals (mg/l)							Filtered Metals (mg/l)								
									Al	As	Cd	Cu	Pb	Mn	Ni	Zn	Al	As	Cd	Cu	Pb	Mn	Ni	Zn
MB1	Count	62																						
	Minimum	196	382	0.01	930	2	24	0.800	0.010	0.0008	<0.0001	0.0010	0.0001	0.0130	0.0010	0.001	<0.01	0.0008	<0.0001		0.001	0.006	0.001	0.0047
	Maximum	206	547	8.00	1445	80	25	2.100	0.130	0.0020	0.0001	0.0150	0.0080	0.3040	0.0280	0.061	0.01	0.0020	0.0002		0.003	0.132	0.004	0.038
	Mean	203	491	7.00	1158	14	24.5	1.579	0.039	0.0012	<0.0001	0.0043	0.0037	0.0651	0.0049	0.021	0.01	0.0011	0.0002	0.002	0.002	0.054	0.002	0.013
	Median	203	496	7.08		9	24.5	1.600	0.030	0.0010	0.0001	0.0030	0.0035	0.0510	0.0020	0.015	0.01	0.0010	0.0002	0.002	0.002	0.042	0.0018	0.01
MB1AB	Count	19																						
	Minimum	198	291	6.20	160	7		1.600	0.040	0.0010	0.0003	0.0010	0.0010	0.0010	0.0010	0.006	0.03		0.0002	0.003	0.002	0.002	0.001	0.009
	Maximum	210	447	7.34	1479	372		4.600	2.930	0.0020	0.0007	0.0190	0.0420	0.1750	0.0040	0.556	0.03		0.0002	0.007	0.006	0.071	0.003	0.223
	Mean	203	408	6.98	1338	122		3.432	0.475	0.0013	0.0005	0.0072	0.0152	0.0384	0.0023	0.104	0.03		0.0002	0.005	0.004	0.013	0.002	0.071
	Median	202	429	7.01	1439	40		3.500	0.080	0.0010	0.0005	0.0035	0.0060	0.0060	0.0020	0.029	0.03		0.0002	0.005	0.004	0.006	0.002	0.0255
MB2	Count	113																						
	Minimum	188	282	6.20	691	1	400	0.600	0.010	0.0005	0.0001	0.0010	0.0001	0.0010	0.0006	0.006	0.01	0.0005	0.0001	0.001	0.000	0.001	0.001	0.001
	Maximum	197	539	8.00	2550	37	449	6.500	0.230	0.0020	0.0004	0.1020	0.0060	0.4220	0.0030	0.085	0.02	0.0020	0.0003	0.094	0.011	0.404	0.003	0.078
	Mean	193	407	7.07	1197	8	431	1.831	0.038	0.0009	0.0002	0.0287	0.0027	0.0557	0.0012	0.024	0.016	0.0009	0.0002	0.025	0.002	0.052	0.001	0.018
	Median	191	410	7.00	1203	6	444	1.700	0.020	0.0010	0.0002	0.0195	0.0021	0.0410	0.0010	0.020	0.02	0.0005	0.0002	0.019	0.002	0.04	0.001	0.01
MB2AB	Count	32																						
	Minimum	189	308	5.65	718	6		0.400	0.010	0.0010	0.0001	0.0010	0.0010	0.0020	0.0010	0.012	0.02	0.0010	0.0001	0.001	0.001	0.001	0.001	0.006
	Maximum	197	470	7.61	1394	270		1.200	3.340	0.0100	0.0013	0.0250	0.1640	0.1590	0.0060	0.383	0.04	0.0010	0.0005	0.003	0.008	0.142	0.002	0.168
	Mean	193	396	6.91	1026	41		0.843	0.449	0.0028	0.0005	0.0057	0.0258	0.0341	0.0033	0.114	0.03	0.0010	0.0003	0.002	0.003	0.015	0.002	0.047
	Median	192	408	6.89	1049	14		0.800	0.130	0.0020	0.0003	0.0020	0.0080	0.0130	0.0030	0.070	0.03	0.0010	0.0003	0.0015	0.0015	0.007	0.002	0.04
MB3	Count	68																						
	Minimum	200	315	6.82	1309	1	713	1.200	0.010	0.0010	0.0001	0.0010	0.0002	0.0010	0.0010	0.006	0.02	0.0010	0.0002	0.001	0.00011	0.001	0.001	0.005
	Maximum	210	2180	8.82	6314	21	904	4.100	0.260	0.0070	0.0014	0.0410	0.0230	0.0860	0.0300	0.186	0.05	0.0040	0.0011	0.028	0.059	0.032	0.021	0.11
	Mean	207	1025	7.19	2975	8	839	2.629	0.058	0.0014	0.0005	0.0073	0.0068	0.0132	0.0057	0.025	0.0325	0.0012	0.0005	0.0050	0.0093	0.0041	0.0034	0.0213
	Median	210	551	7.13	2018	6	901	2.700	0.020	0.0010	0.0001	0.0040	0.0060	0.0040	0.0020	0.012	0.03	0.0010	0.0003	0.003	0.004	0.002	0.002	0.0125
MB3AB	Count	28																						
	Minimum	200	303	6.92	1296	6	161	1.500	0.030	0.0010	0.0009	0.0010	0.0010	0.0040	0.0010	0.006	0.01	0.0010	0.0001	0.001	0.001	0.001	0.001	0.006
	Maximum	209	665	7.70	2883	736	392	3.500	20.500	0.0050	0.0009	0.0400	0.0450	1.1600	0.1300	0.297	0.01	0.0020	0.0001	0.004	0.002	0.04	0.01	0.034
	Mean	205	420	7.21	1699	91	277	2.668	2.833	0.0014	0.0009	0.0087	0.0069	0.2300	0.0143	0.043	0.01	0.0011	0.0001	0.002	0.002	0.005	0.005	0.021
	Median	204	418	7.16	1595	37	236	2.600	1.150	0.0010	0.0009	0.0050	0.0025	0.1235	0.0025	0.016	0.01	0.0010	0.0001	0.002	0.002	0.002	0.004	0.022
MB4	Count	69																						
	Minimum	185	152	5.50	505	1	71	0.400	0.010	0.0010	0.0001	0.0010	0.0010	0.0010	0.0010	0.005	0.03	0.0010	0.0002	0.001	0.001	0.001	0.001	0.004
	Maximum	196	594	8.20	1751	39	108	2.000	0.910	0.0020	0.0010	0.0140	0.0170	0.3320	0.0110	0.106	0.03	0.0020	0.0002	0.007	0.006	0.302	0.009	0.062
	Mean	191	366	7.18	1110	11	84	1.161	0.099	0.0012	0.0003	0.0046	0.0035	0.0648	0.0026	0.029	0.03	0.0012	0.0002	0.003	0.003	0.054	0.002	0.022
	Median	196	370	7.01	1184	7	72	1.050	0.030	0.0010	0.0002	0.0020	0.0020	0.0260	0.0020	0.019	0.03	0.0010	0.0002	0.0025	0.0025	0.0130	0.001	0.021
MB4AB	Count	69																						
	Minimum	186	604	5.86	279	15		0.700	1.280	0.0010	0.0004	0.0020	0.0010	0.1870	0.0030	0.010	<0.01	0.0020	<0.0001	0.0010	0.0010	0.0230	0.001	0.006
	Maximum	196	4320	7.23	13224	6890		1.400	154.000	0.0250	0.0008	0.1940	0.0620	6.9400	0.3130	0.477	<0.01	0.0030	<0.0001	0.0100	0.0030	1.4300	0.008	0.159
	Mean	190	2519	6.81	7094	927		1.036	20.366	0.0056	0.0006	0.0283	0.0124	1.5419	0.0418	0.084	<0.01	0.0023	<0.0001	0.0052	0.0020	0.6139	0.0039	0.038667

		SWL (m)	Hardness (mg/l)	pH	EC µS/cm	TSS (mg/l)	Sulphate (mg/l)	Fluoride (mg/l)	Total Metals (mg/l)							Filtered Metals (mg/l)								
									Al	As	Cd	Cu	Pb	Mn	Ni	Zn	Al	As	Cd	Cu	Pb	Mn	Ni	Zn
	Median	188	2355	6.82	5710	271		1.000	5.930	0.0030	0.0006	0.0085	0.0040	1.2000	0.0140	0.039	<0.01	0.0020	<0.0001	0.0050	0.0020	0.2420	0.004	0.016
MB5	Count	15																						
	Minimum	187	328	5.60	840	3	92	0.000	0.010	0.0008	0.0001	0.0010	0.0010	0.2020	0.0010	0.005	0.01	0.0008	0.0001	0.0010	0.0010	0.0130	0.001	0.0045
	Maximum	202	535	7.70	1585	793	100	1.400	3.500	0.0080	0.0002	0.0170	0.0160	2.6700	0.0200	0.354	0.03	0.0080	0.0002	0.0040	0.0070	0.7980	0.003	0.24
	Mean	196	463	6.88	1174	53	96	0.683	0.200	0.0027	0.0001	0.0049	0.0048	0.5824	0.0039	0.040	0.016667	0.0028	0.000167	0.0025	0.0026	0.4861	0.001883	0.0325
	Median	202	486	6.85	1218	8	96	0.500	0.050	0.0020	0.0001	0.0035	0.0040	0.5935	0.0020	0.016	0.01	0.0020	0.0002	0.0030	0.0020	0.5575	0.00165	0.011
MB6	Count	59																						
	Minimum	188	179	6.00	438	3	13	0.200	0.020	0.0010	0.0001	0.0010	0.0002	0.1460	0.0010	0.005	0.01	0.0010	0.0001	0.0010	0.0002	0.0700	0.001	0.007
	Maximum	201	526	8.15	1790	42	17	1.400	0.410	0.0060	0.0009	0.0520	0.0210	0.9730	0.0080	0.581	0.03	0.0050	0.0005	0.0170	0.0080	0.9160	0.003	0.485
	Mean	195	376	6.88	1056	15	15	0.896	0.099	0.0031	0.0003	0.0088	0.0054	0.4814	0.0023	0.061	0.02	0.0030	0.000233	0.0039	0.0028	0.4412	0.001986	0.044244
	Median	201	367	6.85	972	10	15	1.000	0.065	0.0030	0.0001	0.0060	0.0035	0.4810	0.0020	0.021	0.02	0.0030	0.0001	0.00205	0.002	0.444	0.002	0.021
MB9D	Count	33																						
	Minimum	188	473	5.71	3	5	45	0.200	0.010	0.0010	0.0002	0.0010	0.0010	0.2270	0.0010	0.005	0.01	<0.001	0.0001	0.001	0.002	0.003	0.001	0.0011
	Maximum	189	601	7.48	1491	886	47	0.700	10.200	0.0110	0.0017	0.1430	0.1250	14.6000	0.0380	0.492	0.01	<0.001	0.0002	0.004	0.002	1.12	0.004	0.053
	Mean	189	538	6.73	1184	116	46	0.450	0.997	0.0036	0.0006	0.0198	0.0252	1.3538	0.0068	0.115	0.01	<0.001	0.000175	0.002333	0.002	0.530042	0.001938	0.023675
	Median	189	539	6.74	1228	36	46	0.500	0.120	0.0010	0.0004	0.0080	0.0090	0.5510	0.0020	0.051	0.01	<0.001	0.0002	0.002	0.002	0.4985	0.00125	0.0215
MB9S	Count	6																						
	Minimum	190	18	5.08	109	68	2	0.100	2.570	0.0010		0.0160	0.0010	0.0220	0.0040	0.008	0.02			0.001		0.003		0.015
	Maximum	204	105	7.46	301	618	2	0.100	10.700	0.0020		0.0690	0.0050	0.3100	0.0140	0.044	0.21			0.001		0.028		0.015
	Mean	197	44	6.37	178	271	2	0.100	6.120	0.0015		0.0340	0.0033	0.1415	0.0065	0.024	0.09			0.001		0.01525		0.015
	Median	198	26	6.64	126	126	2	0.100	5.605	0.0015		0.0255	0.0035	0.1170	0.0040	0.022	0.04			0.001		0.015		0.015
Saturday Bore	Count	29																						
	Minimum	173	125	6.00	200	6	148	0.800	0.020	0.0008	<0.0001	0.0020	0.0010	0.2000	0.0010	0.006	<0.01	0.0007	<0.0001	0.002	<0.001	0.194	0.001	0.0012
	Maximum	182	447	8.19	2193	82	153	2.100	0.980	0.0020	<0.0001	0.0130	0.0080	1.8100	0.0030	0.106	<0.01	0.0010	<0.0001	0.002	<0.001	1.62	0.006	0.013
	Mean	177	387	7.10	1714	26	150.5	1.595	0.191	0.0012	<0.0001	0.0048	0.0043	0.7028	0.0020	0.024	<0.01	0.0010	<0.0001	0.002	<0.001	0.6766	0.0023	0.0068
	Median	176	403	7.00	1784	7	150.5	1.700	0.080	0.0010	<0.0001	0.0020	0.0040	0.5360	0.0020	0.011	<0.01	0.0010	<0.0001	0.002	<0.001	0.533	0.002	0.0065
SHALL 6AB	Count	5																						
	Minimum	182	541	6.90	1298	937		2.000	2.270	0.0040	<0.0001	0.0010	0.0080	1.1000	0.0050	0.075	<0.01	0.0020	<0.0001	<0.001	<0.001	0.082	0.001	0.007
	Maximum	211	619	7.32	1334	937		2.200	20.600	0.0040	<0.0001	0.0080	0.0080	1.1000	0.0460	0.075	<0.01	0.0020	<0.0001	<0.001	<0.001	0.082	0.005	0.01
	Mean	203	581	7.19	1323	937		2.100	11.435	0.0040	<0.0001	0.0045	0.0080	1.1000	0.0255	0.075	<0.01	0.0020	<0.0001	<0.001	<0.001	0.082	0.003	0.0085
	Median	207	583	7.26	1329	937		2.100	11.435	0.0040	<0.0001	0.0045	0.0080	1.1000	0.0255	0.075	<0.01	0.0020	<0.0001	<0.001	<0.001	0.082	0.003	0.0085
GWBFAB	Count	1																						
	Minimum	196	407	7.09	1240	124		1.300	1.580	0.0450	0.0076	0.0280	0.6170	0.2390	0.0060	4.490	<0.01	0.0100	0.003	<0.001	0.008	0.197	0.001	1.31
	Maximum	204	407	7.09	1240	124		1.300	1.580	0.0450	0.0076	0.0280	0.6170	0.2390	0.0060	4.490	<0.01	0.0100	0.003	<0.001	0.008	0.197	0.001	1.31
	Mean	201	407	7.09	1240	124		1.300	1.580	0.0450	0.0076	0.0280	0.6170	0.2390	0.0060	4.490	<0.01	0.0100	0.003	<0.001	0.008	0.197	0.001	1.31
	Median	201	407	7.09	1240	124		1.300	1.580	0.0450	0.0076	0.0280	0.6170	0.2390	0.0060	4.490	<0.01	0.0100	0.003	<0.001	0.008	0.197	0.001	1.31
MB10	Count	1																						
	Minimum	176	630	6.80	1627	544		2.700	0.530	4.9400	0.0780	0.0060	0.0380	1.4000	0.0150	89.900	<0.01	0.0240	0.0009	<0.001	<0.001	0.61	0.004	3.16
	Maximum	176	630	6.80	1627	544		2.700	0.530	4.9400	0.0780	0.0060	0.0380	1.4000	0.0150	89.900	<0.01	0.0240	0.0009	<0.001	<0.002	0.61	0.004	3.16
	Mean	176	630	6.80	1627	544		2.700	0.530	4.9400	0.0780	0.0060	0.0380	1.4000	0.0150	89.900	<0.01	0.0240	0.0009	<0.001	<0.003	0.61	0.004	3.16
	Median	176	630	6.80	1627	544		2.700	0.530	4.9400	0.0780	0.0060	0.0380	1.4000	0.0150	89.900	<0.01	0.0240	0.0009	<0.001	<0.004	0.61	0.004	3.16

	Count	SWL	Hardness	pH	EC	TSS	Sulphate	Fluoride	Total Metals (mg/l)							Filtered Metals (mg/l)								
		(m)	(mg/l)		µS/cm	(mg/l)	(mg/l)	(mg/l)	Al	As	Cd	Cu	Pb	Mn	Ni	Zn	Al	As	Cd	Cu	Pb	Mn	Ni	Zn
MB11	1																							
	Minimum	148	114	2.92	3325	40		3.000	21.100	1.4000	9.4500	2.8000	2.9200	13.9000	0.6530	469.000	17.8	1.2300	9	2.76	2.35	12.7	0.62	465
	Maximum	188	114	2.92	3325	40		3.000	21.100	1.4000	9.4500	2.8000	2.9200	13.9000	0.6530	469.000	17.8	1.2300	9	2.76	2.35	12.7	0.62	465
	Mean	158	114	2.92	3325	40		3.000	21.100	1.4000	9.4500	2.8000	2.9200	13.9000	0.6530	469.000	17.8	1.2300	9	2.76	2.35	12.7	0.62	465
	Median	152	114	2.92	3325	40		3.000	21.100	1.4000	9.4500	2.8000	2.9200	13.9000	0.6530	469.000	17.8	1.2300	9	2.76	2.35	12.7	0.62	465

### 3.1.10.5. Hydrogeology

A conceptual hydrogeological model for the Project has been refined by CDM Smith Australia Pty Ltd. CDM Smith (2019) describe the hydrogeology as being recharged predominately via diffuse infiltration from rainfall on the Knapdale Range. Information to date indicates that groundwater flows from west to east beneath the mining and processing areas (mine infrastructure area).

Groundwater movement is generally within the unweathered fracture zones of the Mount Roseby Schist with North and Silvermine Creeks acting as potential preferential flow paths. Basal flow contribution is unlikely given the depth to groundwater being > 4m. Groundwater discharge is seasonal with likely basal flow contribution to the Dugald River.

The permeability of the surrounding sedimentary rock is generally low which is thought to mitigate the potential for a cone of depression from dewatering activities.

An additional conceptual model will be developed closer to closure to account for underground mine development. The model will consider the placement of potentially acid forming (PAF) material underground, as well as the footprint of the TSF.

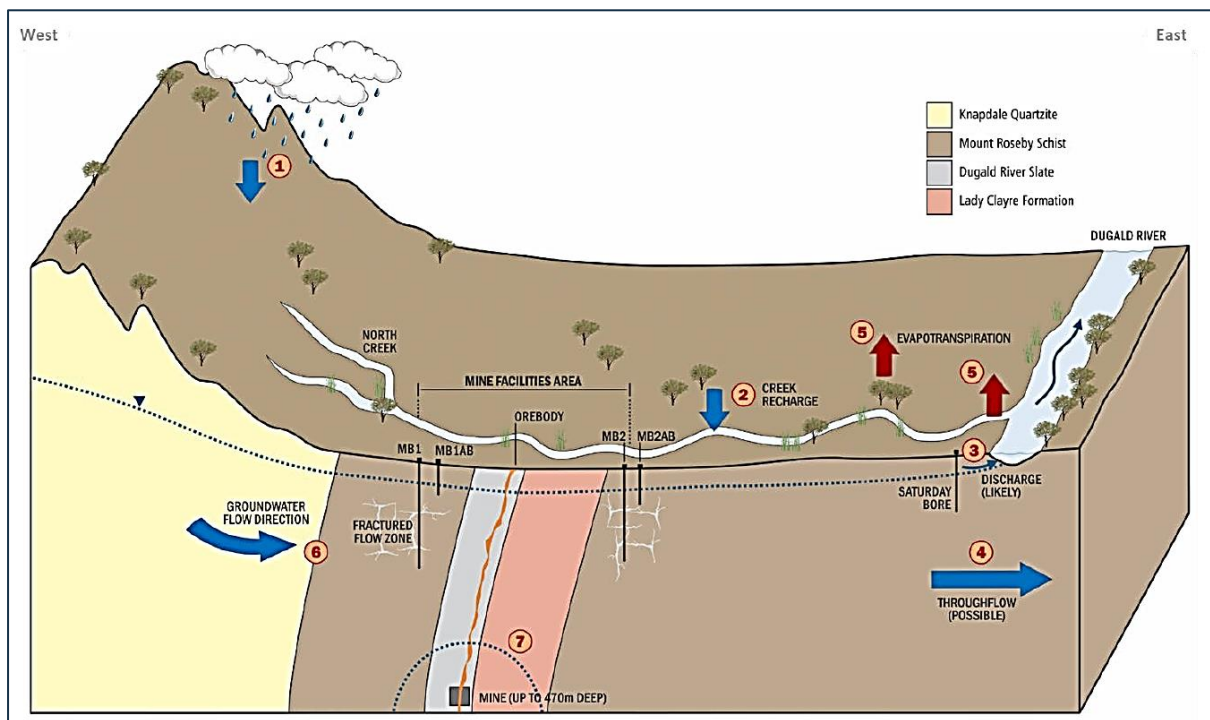


Figure 8. Conceptual Hydrogeological Model for the Dugald River Mine (CGM Smith 2019)

### 3.1.10.6. Soils

#### 3.1.10.6.1. Soil types

The soils of DRM area were described in AustralAsian Resource Consultants (AARC 2010a) and were dominated by Rudosols with minor areas of Calcarosols. The Australian Soil Classification (Isbell, 2016) define Rudosols as being soil with negligible pedology, minimal development of an A1 horizon or the presence of less than 10% of B horizon material (including pedogenic carbonate) in fissures in the parent rock or saprolite. The soils are apedal or only weakly structured in the A1 horizon and show no pedological colour changes apart from the darkening of an A1 horizon. There is little or no texture or colour change with depth unless stratified or buried soils are present.

Specifically, six soil types were described by AARC (2010a) in SGM Environmental Pty Limited (SGM (2021) (Table 13). All soil management units are dominated by features that severely limit their productive use in grazing or copping due to very low plant-available water, erosion potential and limited nutrient availability. Subsequent to the AARC (2010a) soil surveys, several pockets of dispersive red clays were identified during construction.

**Table 13. DRM Soil Types (AARC 2010a)**

Soil Type	Description
<b>Red Plains</b>	The Red Plains SMU consists of red sandy loams to sandy clay loams with a neutral to slightly acidic pH. These soils are Rudosols with weak pedality and a maximum depth of 0.5 m.
<b>Knapdale</b>	The Knapdale SMU consists of brown skeletal sandy clay loams with a neutral to slightly acidic pH. These soils are Rudosols and very shallow (less than (<)0.2 m thick). They are mostly found on the eastern and western slopes of the Knapdale Range.
<b>Dale</b>	The Dale SMU consists of brown to reddish sandy loams with a slightly acidic pH increasing down the profile. Pedality ranges from weak to moderate with a depth of between 0.5-0.7 m. These soils are Rudosols and are generally found in depressions such as valley floors or plateaus in the Knapdale Range.
<b>Miners</b>	The Miners SMU consists of dark yellowish-brown sandy clay loams to silty loams with a slightly alkaline pH. Pedality is weak with a maximum depth of 0.2 m. These soils are Rudosols and are found on and immediately supporting the outcropping of the Dugald River deposit lode on the eastern side of the Knapdale Range.
<b>Prospectors</b>	The Prospectors SMU consists of dark yellowish-brown clay loams with a slightly acidic pH. Pedality is weak with a maximum depth of 0.2 m. These soils are Rudosols and are found on the toe slope of the western side of the Knapdale Range.
<b>Pocket</b>	The Pocket SMU consists of brown-grey sandy clay loams with an alkaline pH due to elevated levels of calcium carbonate. Pedality is weak. These soils are Calcarosols and are found in small pockets on the eastern and northern side of the Knapdale Range.

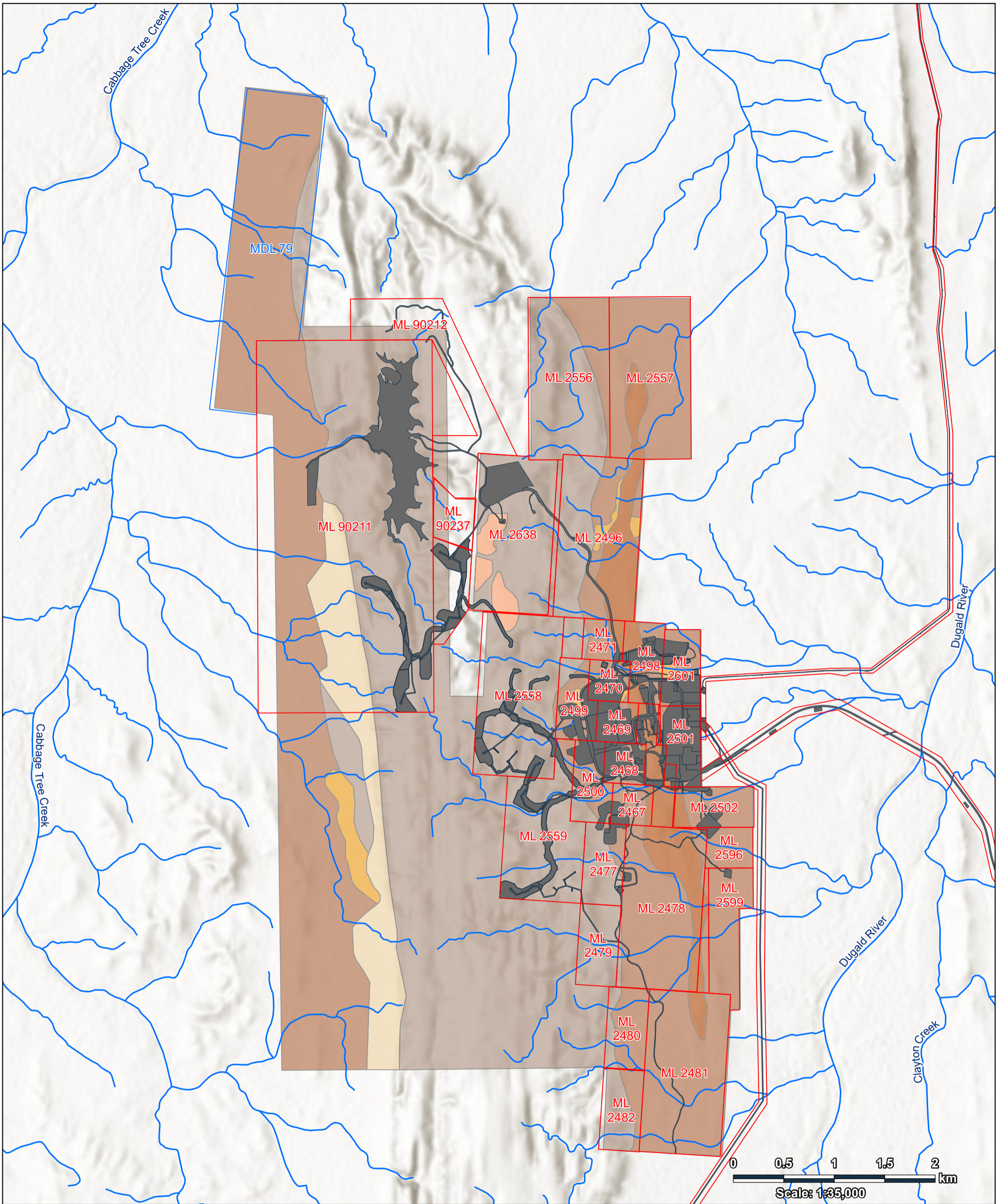
### 3.1.10.6.2. Soil properties

Laboratory analysis of several soil parameters is summarised in Table 14. The soil types currently support native vegetation communities and there are no detrimental elements in the soil expected to limit that capacity in future (AARC, 2010).

**Table 14. Rehabilitation Related Chemical Properties**

Soil Type	pH	EC (ds/cm)	Organic Carbon (%w/w)	CEC (meq/100mg)	ESP (%)
Red Plains	6.5	0.06	0.5	5.88	0.6
Knapdale	6.41	0.02	0.4	4.20	1.75
Dale	5.74	0.03	0.3	2.74	1.7
Miners	7.56	0.04	0.5	10.65	0.9
Prospectors	6.51	0.02	0.7	5.34	1.3
Pocket	8.8	0.08	0.5	22.89	0.5





**Figure 9. Soils**

Client: MMG Dugald River Pty Ltd  
 Project Number: 2023.03002  
 Publication Date: 24/11/2023

Spatial Reference  
 PCS: GDA2020 MGA Zone 54  
 GCS: GDA2020  
 Datum: GDA2020

Print on A3

**Legend**

- |                             |             |
|-----------------------------|-------------|
| Mining Lease                | Knapdale    |
| Mineral Development License | Miners      |
| Watercourse (VM Act)        | Pocket      |
| Existing Disturbance        | Prospectors |
| Soils                       | Red Plain   |
| Dale                        |             |

Disclaimer:  
 Whilst every effort and care has been taken to ensure the accuracy of this report, Wulguru Technical Services Pty Ltd makes no representations or warranties about its accuracy, reliability, completeness or suitability for any particular purpose and disclaims all responsibility and all liability (including without limitation, liability in negligence) for all expenses, losses, damages (including indirect or consequential damage) and costs which you might incur as a result of the product being inaccurate or incomplete in any way and for any reason. Digital data for this report is available on the Queensland Government Spatial Portal at <https://qldspatial.information.qld.gov.au>.



### 3.1.10.6.3. Agricultural Land Classes

The soil management units have been classified into land classes according to the *Planning Guideline -The Identification of Good Quality Agricultural Land* published by the Department of Infrastructure and Planning (DIP), 1993. Agricultural land classes are described in Table 15.

**Table 15. Agricultural Land Classes**

Class	Description	
A	Crop Land	Land that is suitable for current and potential crops with limitations to production which range from non to moderate levels.
B	Limited Crop Land	Land that is marginal for current and potential crops due to severe limitations: and suitable for pastures. Engineering and/or agronomic improvements may be required before the land is considered for cropping.
C	Pasture Land	Land that is suitable only for improved or native pastures due to limitations which preclude continuous cultivation for crop production; but some areas may tolerate short period of ground disturbance for pasture establishment.
D	Non-Agricultural Land	Land not suitable for agricultural uses due to extreme limitations. This may be undisturbed land with significant habitat, conservation and/or catchment values or land that may be unsuitable because of very steep slopes, shallow soils, rock outcrops and poor drainage.

Table 16 details the agricultural land class of each soil management unit based on the descriptions provided in Table 15. No soil management unit on the site was found to be good quality agricultural land due to limiting factors, such as water availability, low nutrient levels, shallow soils, steep slopes and rocky outcrops (AARC, 2010).

**Table 16. Agricultural Land Class of the Project soils from AARC (2010)**

Soil Management Unit	Limiting features	Agricultural Land Class
Red Plains	No available water, relatively shallow soil, low nutrient levels.	D
Knapdale	No available water, shallow rocky soil, low nutrient levels and steep slopes.	D
Dale	This soil type may be suitable as pasture land as it is found up to 50-70 cm however it still has low nutrient levels and it is very inaccessible as it is surrounded by steep slopes.	D
Miners	Shallow and rocky, high levels of lead, rocky outcrops, no available water and low nutrients.	D
Prospectors	No available water, shallow soil, low nutrient levels.	D
Pocket	No available water, relatively shallow soil, low nutrient levels, slightly alkaline.	D

#### 3.1.10.6.4. Land Suitability Assessment

AARC (2010) conducted a land suitability assessment during the initial EIS for the project. Land suitability was assessed using the methods and criteria provided in the *Planning Guideline – The Identification of Good Quality Agricultural Land* (Department of Infrastructure and Planning (DIP), 1993) and the Department of Minerals and Energy *Land Suitability Assessment Techniques Guideline* (Department of Minerals and Energy, 1995).

The Land Suitability assessment uses a five-class system, where Class 1 indicates that the land is most suitable for the enterprise and Class 5 the least suitable. The overall land suitability ranking for each specific soil unit is determined by the most severe limitation, or a combination of the varying limitations. Land is considered less suitable as the severity of limitations for a land use increase. The increasing limitations may reflect any combination of:

- Reduced potential for production;
- Increased inputs to achieve an acceptable level of production; and/or
- Increased inputs required to prevent land degradation.

The Land Suitability Classes are described in Table 17.

**Table 17. Land Suitability Classes**

Class	Suitability	Limitations	Description
1	Suitable	Negligible	Highly productive land requiring only simple management practices to maintain economic production.
2	Suitable	Minor	Land with limitations that either constrain production, or require more than the simple management practices of class 1 land to maintain economic production.
3	Suitable	Moderate	Land with limitations that either further constrain production, or require more than those management practices of class 2 land to maintain economic production.
4	Unsuitable	Severe	Currently unsuitable land. The limitations are so severe that the sustainable use of the land in the proposed manner is precluded. In some circumstances, the limitations may be surmountable with changes to knowledge, economics or technology.
5	Unsuitable	Extreme	Land with extreme limitations that preclude any possibility of successful sustained use of the land in the proposed manner.

The pre-mining land use suitability for these six soil types are summarised in Table 18.



**Table 18. Land Suitability Assessment for Project Soils**

Soil Type	Beef Cattle Grazing	Broadacre Cropping	Conservation	Limitations	Area (ha)
Red Plains	4	5	4	Severe to Extreme Limitations in plant available water capacity (PAWC). Extreme Limitation in Slope, Topography, Rockiness.	1327
Knapdale	5	5	4	Extreme Limitation in Slope, Rockiness, PAWC and Topography.	1623
Dale	4	5	4	Severe to Extreme Limitation in PAWC and access.	38
Miners	5	5	4	Extreme Limitation in Rockiness, and PAWC.	166
Prospectors	5	5	4	Extreme Limitation in Rockiness, and PAWC.	165
Pocket	4	5	4	Extreme Limitation in Rockiness, and PAWC.	48

### 3.1.10.7. Land Stability

#### 3.1.10.7.1. Soil Erosion Susceptibility

An assessment of soil erosion susceptibility is given in Table 19, which lists influencing factors for each soil type.

**Table 19. Soil Erosion Susceptibility**

Soil Type	Sodicity	Texture	Landform	Vegetation cover	Erosion Susceptibility
Red Plains	Non- Sodic	Sandy loam to sandy clay loam	Flatter plain areas	Cloncurry Box and Snappy Gum Open Woodland	Nondispersive
Knapdale	Non- Sodic	Sandy clay loam	Slopes of The Knapdale Range (30-40°)	Snappy Gum Open Woodland and Spinifex grass	Nondispersive
Dale	Non- Sodic	Sandy loam	Valley floors or plateaus in the Knapdale Range	Snappy Gum Open Woodland	Nondispersive
Miners	Non-Sodic	Sandy clay loam	Outcropping of the deposit lode	Cloncurry Box Open Woodland	Nondispersive
Prospectors	Non- Sodic	Clay loam	Toe slope of The Knapdale Range	Snappy Gum Open Woodland	Nondispersive



Pocket	Non- Sodic	Sandy clay loam	Areas of low relief pockets (<5°)	Snappy Gum and Cloncurry Box Open Woodland	Nondispersive
--------	------------	-----------------	-----------------------------------	--	---------------

### 3.1.10.7.2. Erosion Hazard (Average Rainfall)

The International Erosion Control Association's (IECA) Best Practice Erosion and Sediment Control Guidelines (IECA 2008) sets erosion hazard based on average rainfalls for regions around Australia. IECA erosion hazard for the Mt Isa region is detailed in Table 20.

**Table 20. Erosion Hazard (IECA, 2008)**

Jan	Feb	Mar	Apr	May	June	July	Aug	Sept	Oct	Nov	Dec
High	High	Medium	Very Low	Very Low	Very Low	Very Low	Very Low	Very Low	Very Low	Very Low	Medium

### 3.1.10.8. Geology

The DRM is located within a north to south trending feature named the Mt Roseby Corridor, within the Eastern Fold Belt of the Mount Isa Inlier. The Mount Roseby Corridor is bordered to the west by the Knapdale Quartzite and to the east by the Mt Rosebee Fault. The Knapdale Quartzite forms the Knapdale Range, a local topographic high. The Mount Roseby corridor is comprised of the Mount Roseby Schist Formation which includes the Dugald River Slate Sequence of hanging wall calc-silicates, Dugald River slate (host of the ore body) and the footwall limestone (SGM, 2021).

The geology of the rock units mined at the Project were described in EGi (2011). The units are calc-silicate, white mica schist, mafic feldspar porphyry, hanging wall slate, mineralized lode waste, footwall slate, and footwall limestone. Waste mined was found to be predominately non-acid forming (NAF) but areas of potentially acid forming (PAF) rock may be encountered proximal to the ore body and minor volumes within the hanging and foot wall slate. Table 21 describes the four dominant geological units at DRM.

**Table 21. Mapped Geology for The Project Area**

Geological Unit	Description	Age
Lady Clayre Dolomite	Dolomitic, locally pyrrhotitic siltstone, silty to sandy dolostone and fine-grained, variably dolomitic sandstone	Paleoproterozoic
Knapdale Quartzite	Pink, fine-grained, feldspathic to quartzose, locally micaceous sandstone	Paleoproterozoic
Dugald River Slate Sequence	Dark grey, carbonaceous shale and siltstone and grey mica schist; Ore body; and Dark grey silty, dolomitic limestone and siltstone	Paleoproterozoic
Mount Roseby Schist	Grey muscovite-biotite-quartz schist (psammopelite) and minor quartzite, calc-silicate granofels and limestone; commonly thin-bedded with abundant poikiloblastic scapolite porphyroblasts, particularly in the north	Paleoproterozoic

### **3.1.10.9. Vegetation Communities and Ecological Data**

#### **3.1.10.9.1. Matters of National Environmental Significance (MNES)**

There are no Matters of National Environmental Significance, including no World Heritage Properties, National Heritage Places, Wetlands of International Significance (Ramsar sites), Commonwealth Marine Areas or Threatened Ecological Communities mapped to occur within the Project area.

A number of avian species listed as Migratory and/or Marine under the EPBC Act have been identified within database searches and during field surveys of the initial EIS (AARC, 2010). However, no species is at the range of its distribution and no significant habitat or relevant bird flight paths for these species were identified within or immediately adjacent to the Project (AARC, 2010).

#### **3.1.10.9.2. Matters of State Environmental Significance**

The following Matters of State Environmental Significance are mapped (Queensland Government, 2022) to occur within the Project area:

- Wildlife habitat (endangered or vulnerable/ special least concern);
- Regulated vegetation (essential habitat); and
- Regulated vegetation (intersecting a watercourse).

Wildlife habitat and essential habitat within the Project area are associated with the presence of the *Petrogale purpureicollis* (purple-necked rock-wallaby) (Figure 10).

#### **3.1.10.9.3. Environmentally Sensitive Areas**

The Protected Matters Search Tool (PMST) (Department of Agriculture Water and the Environment DAWE, 2022) identified the following Category B Environmentally Sensitive Area within the Project:

- Endangered regional ecosystem 1.3.7– Red Gum (*Eucalyptus camaldulensis*) woodland on channels and levees.

#### **3.1.10.9.4. Regional Ecosystems**

The Project area was largely classed as remnant under the *Vegetation Management Act 1999* (VM Act) with the current footprint now classed as non-remnant. Mapped regional ecosystems (RE) were reviewed using the Queensland Globe interactive mapping tool (QLD, 2022). REs were identified and are described in Table 22 (Figure 11). Of the identified REs, *Eucalyptus camaldulensis* woodland on channels and levees (River Red Gum Riparian Woodland) was listed as endangered and *Acacia cambagei* low woodland on metamorphic hills (Gidgee woodland) as of concern under the Department of Environment and Science Biodiversity Status.

**Table 22. Mapped Vegetation Communities and Their Current Conservation Status (Qld 2021)**

Vegetation community	RE	VM Act (Qld)	Biodiversity status
<i>Eucalyptus leucophloia</i> low open woodland.	1.11.2	Least Concern	No Concern
<i>Corymbia terminalis</i> and / or <i>Eucalyptus leucophylla</i> low open woodland on metamorphics.	1.11.3	Least Concern	No Concern
<i>Acacia cambagei</i> low woodland on metamorphic hills.	1.11.7	Of concern	Of concern
<i>Terminalia aridicola</i> and / or <i>corymbia aspera</i> low open woodland to low woodland, usually with vine-scrub species, on rock outcrops.	1.11.8	Least Concern	No Concern
<i>Eucalyptus leucophloia</i> low open woodland on granites.	1.12.1	Least Concern	No Concern
<i>Eucalyptus leucophylla</i> woodland on levees and minor drainage lines.	1.3.13	Least Concern	No Concern
<i>Corymbia aparrerinja</i> , <i>Corymbia terminalis</i> woodland on sandy levees	1.3.6	Least Concern	No Concern
<i>Eucalyptus camaldulensis</i> woodland on channels and levees.	1.3.7	Least Concern	Endangered
<i>Eucalyptus pruinosa</i> low open woodland on older alluvial and residual soils.	1.5.13	Least Concern	No Concern
<i>Eucalyptus leucophylla</i> and / or <i>Corymbia terminalis</i> low open woodland on red earths.	1.5.4	Least Concern	No Concern
<i>Corymbia capricornia</i> and / or <i>eucalyptus leucophloia</i> or <i>Eucalyptus miniata</i> low open woodland on silcrete.	1.7.7	Least Concern	No Concern
Waterholes, bare sand and rock in the channels of major watercourses.	2.3.50	Least Concern	No Concern

#### 3.1.10.9.5. Regulated Vegetation

Regulated vegetation is vegetation managed through the VM Act. Vegetation classifications described by the VM Act as being Category A, Category B, Category C, Category R or Category X are required to meet certain criteria prior to impact.

The entire DRM ML is mapped as Category B.

#### 3.1.10.9.6. Threatened Flora

The Protected Matters Search Tool (PMST) (Department of Agriculture Water and the Environment DAWE, 2022) did not identify any threatened flora species within the project area.

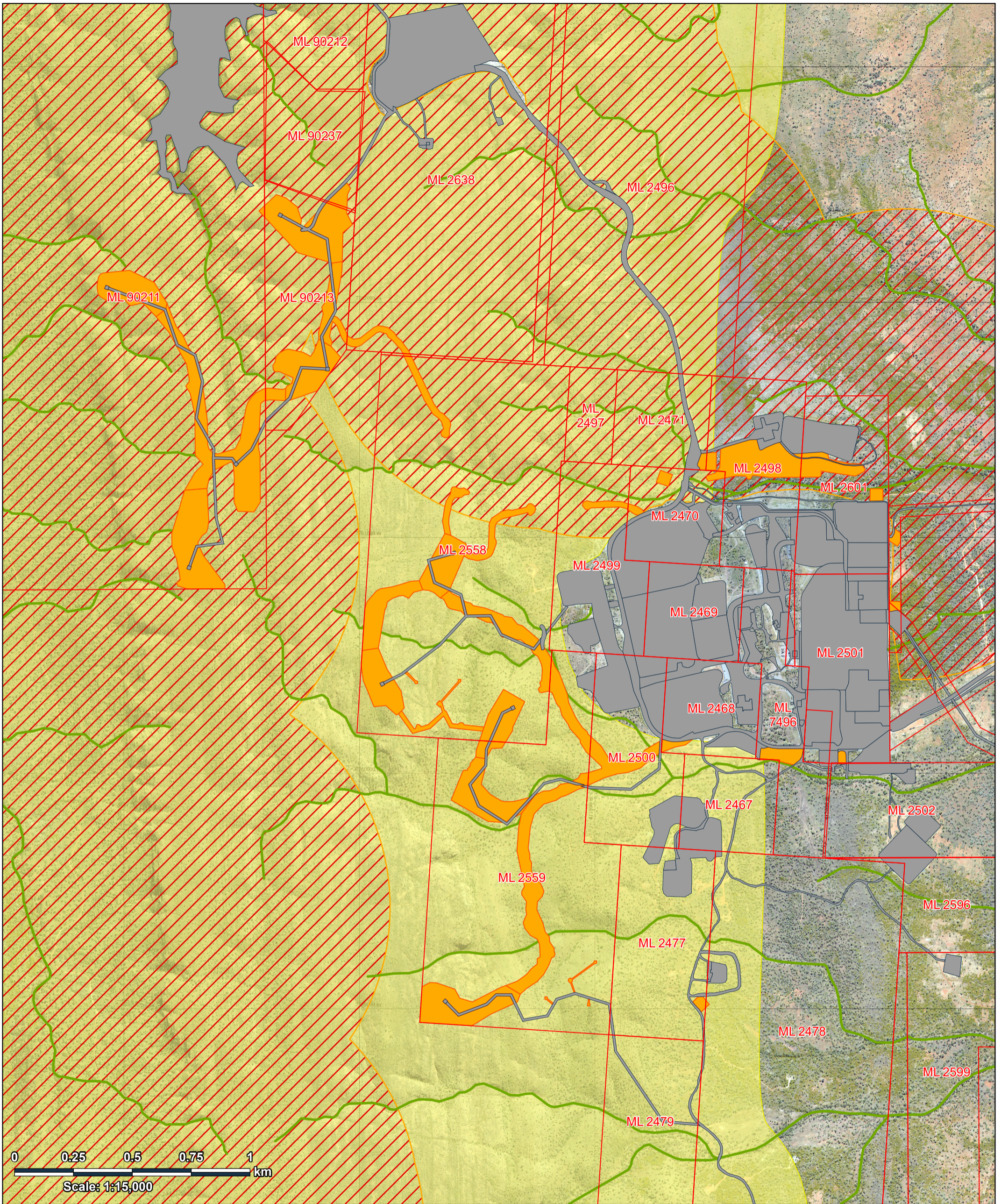


#### **3.1.10.9.7. Threatened Fauna**

One mammal species of conservation significance was identified during the 2011 surveys, *Petrogale purpureicollis* (purple-necked rock-wallaby). This species is listed as vulnerable under the *Nature Conservation Act 1992 (Qld)*. The purple-necked rock-wallaby (PNRW) is associated with the rocky scarps of the Knapdale Range and significant rocky outcrops of the plains. The rocky habitat provides refuge from predators and thermal extremes. Seasonal monitoring of the PNRW has identified little evidence of impacts from mining activities despite the existence of the TSF within known habitat (Ecosmart Ecology 2020a).

Monitoring of the purple-necked rock-wallaby in 2015 identified a second mammal of conservation significance, the mouse-like carnivorous *Pseudantechinus mimilus* (Carpentarian Pseudantechinus). The species was listed as vulnerable under the *Environmental Protection and Biodiversity Act 1999 (Cth)* at the time but has subsequently been delisted in 2019 (Threatened Species Scientific Committee 2019). Federal Government approvals led to the development of a species management plan to minimise, mitigate, and monitor for harm. The species habitat are rocky outcrops throughout the Project area and have been anecdotally identified in man-made rockpiles close to the site infrastructure.





Client: MMG Dugald River Pty Ltd  
 Project Number: 2023.03002  
 Publication Date: 28/11/2023

Spatial Reference  
 PCS: GDA2020 MGA Zone 54  
 GCS: GDA2020  
 Datum: GDA2020

Print on A3

### Legend

- |   |  |
|---|--|
|  Proposed Disturbance Extent |  WH - Endangered Vulnerable |
|  Existing Disturbance        |  RV - Watercourse           |
|  Mining Lease                |  RV - Essential Habitat     |

## Figure 10. Matters of State Environmental Significance

Disclaimer:  
 Whilst every effort and care has been taken to ensure the accuracy of this report, Wulguru Technical Services Pty Ltd makes no representations or warranties about its accuracy, reliability, completeness or suitability for any particular purpose and disclaims all responsibility and all liability (including without limitation, liability in negligence) for all expenses, losses, damages (including indirect or consequential damage) and costs which you might incur as a result of the product being inaccurate or incomplete in any way and for any reason. Digital data for this report is available on the Queensland Government Spatial Portal at <https://qldspatial.information.qld.gov.au>.



**WULGURU TECHNICAL SERVICES**



**Figure 11. Regional Ecosystems**

## 3.2. Community

### 3.2.1. Community Profile

Cloncurry is the closest township to the Project, located approximately 65 km southeast of the Project. The 2021 Census recorded 3644 people in the population, 56.6% male and 43.4 % female with a median age of 34. The labour force was recorded to be 1,904 people, with 64.9 % working full time. Technicians and Trades Workers was the largest employment industry (19.8%) followed by Machinery Operators and Drivers (17.9%) (ABS, 2021).

The nearest regional centre is Mount Isa, located 80 km southwest of DRM. Mount Isa has a population of over 18,000 and is the administrative, commercial, and industrial centre for north-western Queensland. As of the 2021 Census, the population was 18,727, with a median age of 31 with 51.6% male and 48.4 % female. The labour force was recorded to be 9,790 people, 70.4 % working full time. Technicians and Trades Workers was the largest employment industry at 20.8 % of the working population (ABS, 2021).

The Project employs approximately 500 employees and contractors with a mix of fly-in, fly-out workforce and local Cloncurry residents.

### 3.2.2. Community Consultation Plan

MMG has a Community and Social Performance Standard (Appendix G), which defines a range of programs that are implemented to meet community expectations. Within this, is a dedicated Community Engagement Plan (CEP) (Appendix H). This CEP documents the iterative consultation process to be followed to enable ongoing engagement with relevant stakeholders.

DRM has a dedicated Community and Stakeholder Advisor, to manage relationships with external stakeholders. In addition to the CEP, a Community Consultative Committee has been established and meets quarterly. The committee acts as a conduit between DRM and its key stakeholders, for sharing information and receiving feedback. The committee currently includes the following members:

- Commerce North West;
- Cloncurry Business Committee Representatives from the local Government;
- Representatives from the Kalkadoon, Mitakoodi and Mayi groups; and
- Pastoralists/landowners.

A community consultation register has been developed and will continue to be updated throughout the life of mine. In 2023, MMG consulted with the landholders and Kalkadoon People regarding the PRCP, post mining land uses and the addition of the wind farm. Both parties were supportive of the proposed post mining land uses across the entire Project. The minutes from recent consultation is provided in Appendix I and Appendix J.



### 3.3. Post Mining Land Use

Land must be rehabilitated to a stable condition as defined in section 11A of the EP Act. Land is in a stable condition if:

- the land is safe and structurally stable, and
- there is no environmental harm being caused by anything on or in the land, and
- the land can sustain a Post Mining Land Use (PMLU).

A PMLU is defined under the EP Act as the purpose for which the land will be used after all relevant activities have ceased. The PMLU must be consistent with the outcome of consultation with the community and any strategies for the land of a local government, the State or Commonwealth (Department of Environment and Science, 2021).

#### 3.3.1. Rehabilitation Areas

Project activities are grouped in this PRCP by Rehabilitation Areas (RAs), defined under the Progressive Rehabilitation and Closure Plans guideline as “an area of land in the PMLU to which a rehabilitation milestone for the post-mining use relates”.

The RAs for the Dugald River Mine are detailed in Table 23 and mapped in Figure 12.

**Table 23. Rehabilitation Areas and Rehabilitation Milestones**

Rehabilitation Area	Area (ha)
<b>RA1 – Ancillary infrastructure and services</b>	<b>30.3</b>
Accommodation village	
Pipeline and accommodation village road	
<b>RA2 – Borrow pits and stockpiles</b>	<b>43.34</b>
Borrow Pit/Topsoil Stockpile, Borrow Pit A, and Topsoil Stockpile A	
Borrow Pit B	
Borrow Pit C1	
Borrow Pit C2	
Access Road Borrow Pit(s)	
TSF Borrow Pit A	
Topsoil Stockpile B	
Spoil Stockpile 1	
Spoil Stockpile 2	
<b>RA3 – Dams and diversion structures</b>	<b>41.6</b>
Diversion Drains	
Stage 1 PAF PAD Run Off Dam	
Stage 2 PAF PAD Run Off Dam	
Underground Mine Water Collection Dam	
STP Dam Stage 1	
STP Dam Stage 2	
ROM Area Run Off Dam	

<b>Rehabilitation Area</b>	<b>Area (ha)</b>
Raw Water Dam	
Sediment Dam A	
Process Plant Run Off Dam	
Containment Dam	
Mine Workshop Run Off Dam	
Sediment Dam C	
Sediment Dam D	
Sediment Dam F	
Sediment Dam G	
<b>RA4 - Mineralised waste</b>	<b>20.2</b>
PAF WRD	
NAF WRD	
<b>RA5 – Mining and processing area</b>	<b>201.59</b>
ROM pad	
ROM haul road	
Processing plant and conveyor area	
Underground portal and support infrastructure	
Switchyard 1 and 2	
Construction Laydown, Warehouse, Mobile Equipment Laydown and Core Shed	
Office and administration services	
Exploration camp	
Sewage treatment plant	
Workshop and vehicle maintenance	
Raw water pipeline	
Emergency response training	
Explosives magazine	
Communication tower	
Powerlines	
Roads and tracks	
Groundwater infrastructure	
Fuel storage	
West laydown area	
Waste transfer station	
Temporary waste laydown	
Laydown	
<b>RA6 - TSF</b>	<b>216.9</b>
TSF and seepage collection pond	
TSF pipelines and roads	
TSF Borrow Pit B/TSF Stockpile	
<b>RA7 – Renewable Energy Infrastructure</b>	<b>68.35</b>
Wind farm pads and ancillary infrastructure	

Rehabilitation Area	Area (ha)
Roads and tracks (Knapdale Range)	
Laydown west	

**Figure 12. Reference Map**

**Legend**

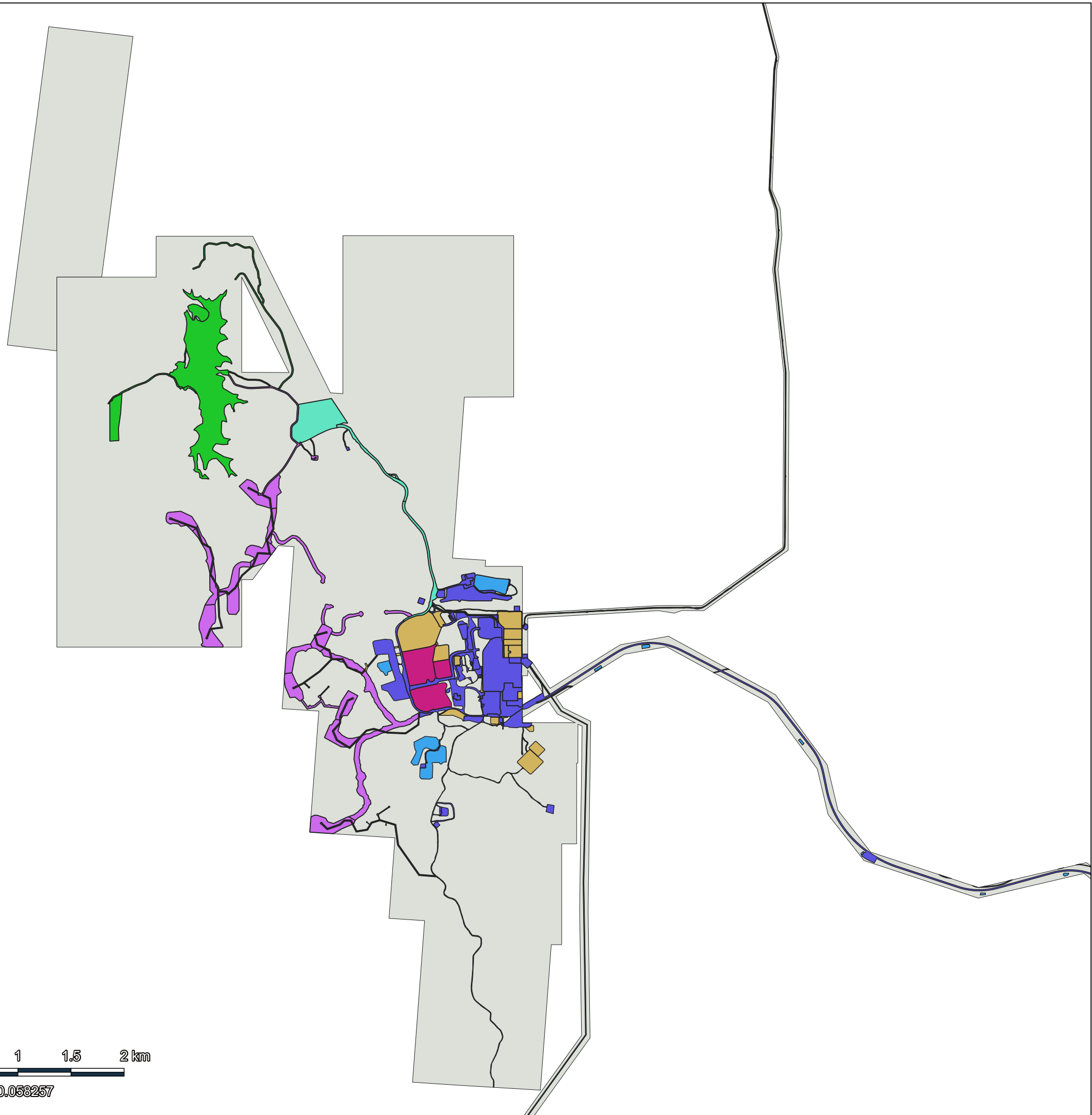
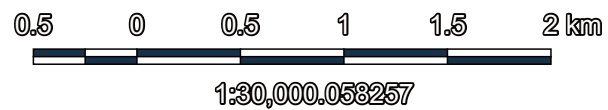
**Rehabilitation Areas**

- RA1
- RA2
- RA3
- RA4
- RA5
- RA6
- RA7
- Undisturbed

Client: Minerals and Metals Group  
Project number: 2023.07002  
CRS: GDA2020 EPSG:7844  
Date: 27 July 2023

Print as A3

**Disclaimer:**  
Whilst every effort and care has been taken to ensure the accuracy of this report, Wulguru Technical Services Pty Ltd makes no representations or warranties about its accuracy, reliability, completeness or suitability for any particular purpose and disclaims all responsibility and all liability (including without limitation, liability in negligence) for all expenses, losses, damages (including indirect or consequential damage) and costs which you might incur as a result of the product being inaccurate or incomplete in any way and for any reason.  
Digital data for this report is available on the Queensland Government Spatial Portal at <https://qldspatial.information.qld.gov.au>.





### **3.3.2.Existing Rehabilitation**

Exploration disturbance is rehabilitated, within 12 months of disturbance activities. Over the course of operations, the location of exploration disturbance will vary however the rehabilitation strategy will remain the same. All exploration disturbance will be completed in accordance with the Environmental Authority and the Code of Environmental Compliance for Exploration and Mineral Development. Land will be rehabilitated to a stable condition that achieves the relevant post mine land use designated for location of disturbance.

### **3.3.3.Assessment of PMLU Options**

As part of the assessment of PMLUs it is acknowledged that the EP Regulation requires that each PMLU:

- a) Is viable having regard to the use of land in the surrounding region, and
- b) Satisfies at least one of the following:
  - a. the use is consistent with how the land was used before a mining activity was carried out on the land;
  - b. the use is consistent with a development approval relating to the land;
  - c. the use is consistent with a use of the land, other than a use that is mining, permitted under a State or Commonwealth Act, including, for example, a planning instrument under the Planning Act 2016; and
  - d. the use will deliver, or is aimed at delivering, a beneficial environmental outcome.

Low intensity grazing was determined to be the most suitable PMLU for the majority of the Project. This was determined by considering the existing rehabilitation objectives specified in the EA and, community consultation, as well as its environmental, economic, and social benefits. Where the topography inhibits cattle grazing (slopes >10%), native ecosystem is proposed as the most suitable PMLU. Table 24 lists the proposed PMLU for each mine domain. PMLUs are discussed further in Section 3.3.

**Table 24. Mine domains and agreed PLMU land classes**

Mine Domain		PMLU
RA1	Ancillary infrastructure and services	Native ecosystem
RA2	Borrow pits and stockpiles	Low intensity grazing
RA3	Dams and diversion structures	Low intensity grazing
RA4	Mineralised waste	Low intensity grazing
RA5	Mining and processing area	Low intensity grazing
RA6	TSF	Native ecosystem
RA7	Renewable energy infrastructure	Native ecosystem

Table 25 describes how these PMLU's meet the requirements of the EP Regulation.

**Table 25. Requirements of a PMLU**

Requirement of a PMLU	Justification
The land is safe and structurally stable, and	<p>All infrastructure will be removed and landforms (e.g. Waste dumps) will be returned to a pre-mining profile. The only feature to remain is the TSF. The final landform of the TSF will be designed by suitably qualified person.</p> <p>After initial rehabilitation, structures will continue to be monitored by suitably qualified persons to assess stability. Erosion monitoring will be conducted to assess stability.</p> <p>The flat areas (&lt;10% slope) will be made safe to support cattle grazing. The natural steep slopes of the Knapdale range inhibit cattle from accessing RA1, RA6 and RA7. These domains have an assigned PMLU of native ecosystem.</p> <p>During rehabilitation, areas may be fenced to prevent cattle grazing until vegetation has established and the landform is unlikely to cause erosion and sedimentation.</p> <p>There will be no voids or water management structures after closure.</p>
There is no environmental harm being caused by anything on or in the land, and	<p>All contaminants will be removed from site. A contaminated land assessment will be conducted following rehabilitation activities to verify the removal of contaminants.</p> <p>All infrastructure and waste will be removed from site during the demolition phase of rehabilitation.</p> <p>All Potentially Acid Forming (PAF) material will be returned to the underground mine void.</p>

Requirement of a PMLU	Justification
	<p>Water from storage dams will be treated, where required, and any contaminated sediment will be removed from site.</p> <p>The site will be revegetated to reduce the possibility of erosion.</p> <p>Ongoing surface and groundwater monitoring will be conducted to assess the potential for environmental harm.</p>
<p>The land can sustain a Post Mining Land Use (PMLU).</p>	<p>The proposed PMLU of low intensity cattle grazing is consistent with surrounding land uses. It is also consistent with the Cloncurry Shire Planning Scheme, rural zone.</p> <p>The PMLU of native ecosystem for RA1, RA6 and RA7 is consistent with the pre-mining land use of these areas.</p>
<p>The PMLU is viable having regard to the use of land in the surrounding region, and</p>	<p>The Cloncurry Shire is a significant beef producing region. The proposed PMLU of low intensity cattle grazing is consistent with previous and current land uses in the area.</p> <p>The PMLU of native ecosystem for RA1, RA6 and RA7 is consistent with the pre-mining land use of the area.</p>
<p>The PMLU satisfies at least one of the following:</p> <ol style="list-style-type: none"> <li>a. the use is consistent with how the land was used before a mining activity was carried out on the land;</li> <li>b. the use is consistent with a development approval relating to the land;</li> <li>c. the use is consistent with a use of the land, other than a use that is mining, permitted under a State or Commonwealth Act, including, for example, a planning instrument under the Planning Act 2016; and</li> <li>d. the use will deliver, or is aimed at delivering, a beneficial environmental outcome.</li> </ol>	<p>The proposed PMLUs of low intensity cattle grazing and native ecosystem are consistent with how the land was used before a mining activity was carried out on the land.</p> <p>The proposed PMLUs are consistent with the rehabilitation objectives defined for each mine domain in Schedule I – Table 1 (Dugald River Project Rehabilitation Requirements) of the EA. The current rehabilitation objectives are a combination of low intensity grazing and native ecosystem.</p>

### 3.3.3.1. Community Consultation

The proposed PMLUs of native ecosystem and grazing are consistent with the community consultation conducted to date, in that they are:

- Consistent with the land use prior to the commencement of mining activities;
- Consistent with the surrounding land use; and
- Compatible with, and beneficial to, the current underlying landholder activities.

In 2023, MMG consulted with the landholders and Kalkadoon People regarding the PRCP, post mining land uses and the addition of the wind farm. Both parties were supportive of the proposed post mining land uses across the entire Project. The minutes from recent consultation is provided in Appendix I and Appendix J.

There are currently no agreements with landholders for any infrastructure to be retained for future land use.

### **3.3.3.2. Regional Planning Integration**

#### **3.3.3.2.1. Cloncurry Shire Planning Scheme**

Under the Cloncurry Shire Planning Scheme 2016 (the Planning Scheme), the Project is within the Rural zone (Cloncurry Shire Council, 2016). The overall purpose of the Rural zone of the Cloncurry Shire is to:

- Provide for rural uses and activities;
- Provide for other uses and activities that are compatible with –
  - Existing and future rural uses and activities;
  - The character and environmental features of the zone;
- Maintain the capacity of land for rural uses and activities by protecting and managing significant natural resources and processes.

The proposed PMLUs of native ecosystem and grazing are compatible with the planning scheme.

#### **3.3.3.2.2. Regional Strategies**

The North West Regional Plan (Queensland Department of Infrastructure and Planning, 2010) identifies both mining and beef production as significant primary industries with long histories in the region. The plan identifies the need to manage the cyclical nature of mining by ensuring that its development complements other industries. The plan also places importance on cultivating a natural environment that is resilient to the impacts of climate change and one that is well managed to maintain biodiversity, ecological processes, water resources and scenic amenity.

The proposed PMLUs of grazing and native ecosystem are compatible with the North West Regional Plan in that they provide an alternative land use (grazing), that is complementary to the mining industry and provides positive environmental outcomes.

Similar to the North West Regional Plan, the Cloncurry Shire Council Economic Development Strategy identifies mining and agriculture as key contributors to the regional economy, as the two highest employment industries. The strategy highlights future development of the beef industry with the potential for expanded saleyards, and beef processing and feed lotting facilities being investigated.



The proposed PMLU of grazing is consistent with the Cloncurry Shire Council Economic Development Strategy.

# Figure 13. Post Mine Land Use

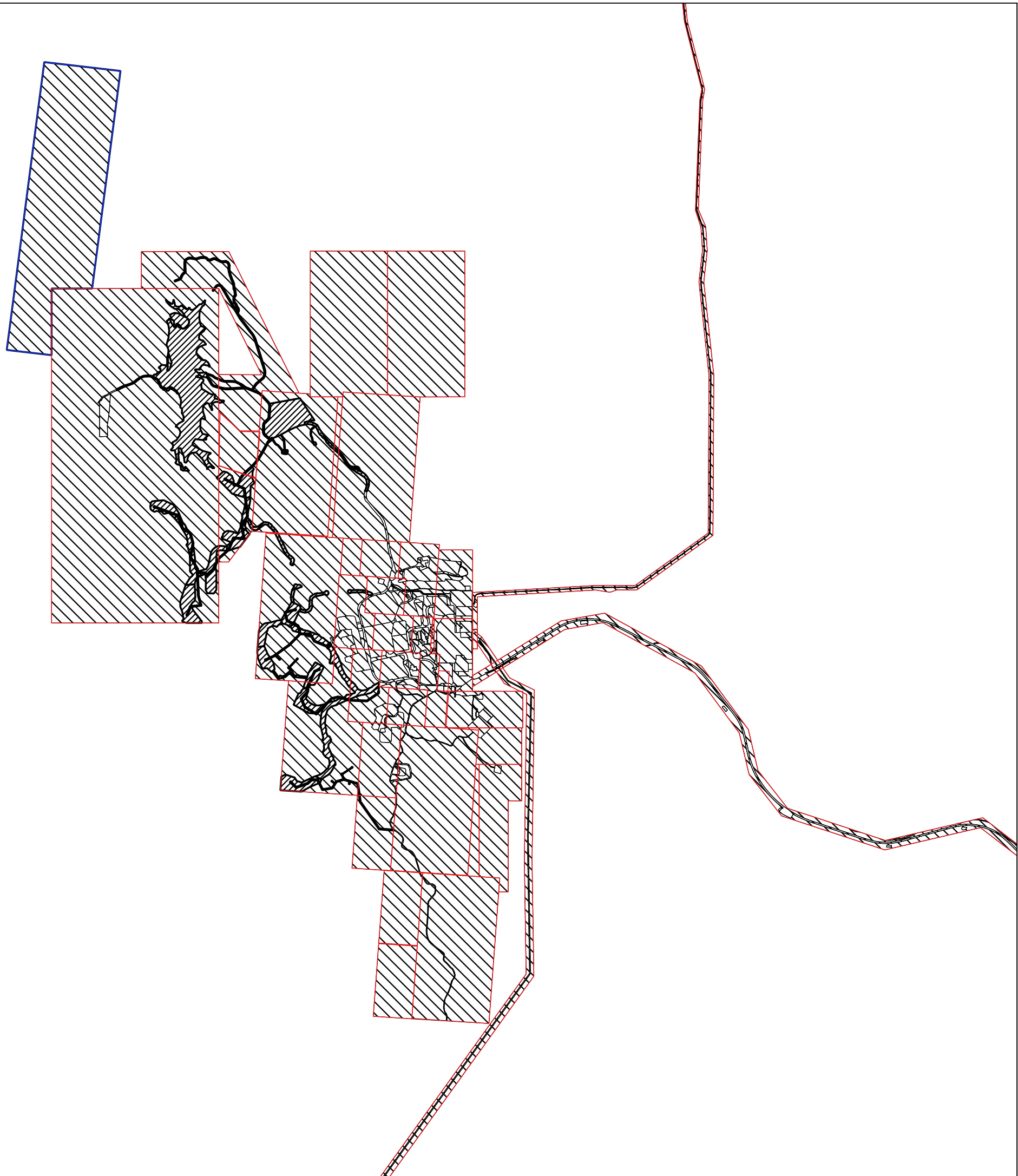
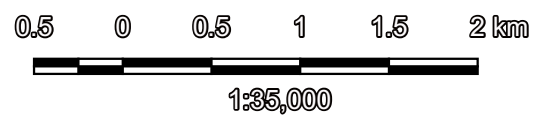
## Legend

- Mine Lease
- Mineral Development Licence
- PMLU
  - GRAZ
  - NAT\_ECO

Client: MMG Dugald River Mine Pty Ltd  
Project number: 2023.07002  
CRS: GDA2020 EPSG:7844  
Date: 1 December 2023

Print as A3

Disclaimer:  
Whilst every effort and care has been taken to ensure the accuracy of this report, Wulguru Technical Services Pty Ltd makes no representations or warranties about its accuracy, reliability, completeness or suitability for any particular purpose and disclaims all responsibility and all liability (including without limitation, liability in negligence) for all expenses, losses, damages (including indirect or consequential damage) and costs which you might incur as a result of the product being inaccurate or incomplete in any way and for any reason.  
Digital data for this report is available on the Queensland Government Spatial Portal at <https://qldspatial.information.qld.gov.au>.



### **3.3.3.3. Proposed PMLU**

#### **3.3.3.3.1. RA1 – Ancillary infrastructure and services**

##### **3.3.3.3.1.1. Overview**

This RA includes the accommodation village, pipeline, and associated roads on the northern section of the ML. The RA is situated on the crest of the Knapdale Range. The area will be ripped however will not be topsoiled, consistent with the natural profile of the Knapdale Range. Revegetation will target species of regional ecosystem 1.11.2a/1.7.7a, consistent with the pre-clearance environment. Target species include *Eucalyptus leucophloia*, *Corymbia terminalis* and *Corymbia capricornia* with a groundcover of *Aristida latifolia*, *Eriachne obtusa*, *Sporobolus australasicus*, *Themeda triandra* and *Triodia pungens*. The target regional ecosystems will support native fauna populations, in keeping with the surrounding habitats. Features such as large woody debris or boulders will be selectively placed to provide suitable refuge for the purple neck rock wallaby.

##### **3.3.3.3.1.2. Outcome**

The PMLU for Ancillary Infrastructure and Services is native ecosystem.

##### **3.3.3.3.1.3. Environmental Benefit**

Revegetation will target species of regional ecosystem 1.11.2a/1.7.7a, consistent with the pre-clearance environment. This will establish connectivity with the surrounding environment. The revegetated area will provide additional habitat for the purple neck rock wallaby, which is known to inhabit the surrounding area.

##### **3.3.3.3.1.4. Economic Benefit**

The PMLU of native ecosystem does not have a direct economic benefit.

##### **3.3.3.3.1.5. Social Benefit**

The social benefit of re-establishing native ecosystem is the aesthetic appearance and cohesion with the surrounding environment.

#### **3.3.3.3.2. RA2 – Borrow Pits and Stockpiles**

##### **3.3.3.3.2.1. Overview**

RA2 of the Project includes borrow pits and topsoil stockpiles. Once borrow pits have been exhausted, the area will be reshaped, where required, to prevent erosion. Topsoil stockpiles will be utilised in rehabilitation activities. The underlying footprint will be ripped and seeded.

##### **3.3.3.3.2.2. Outcome**

The proposed PMLU for the RA2 is low intensity grazing.

#### **3.3.3.2.3. Environmental Benefit**

The establishment of low intensity grazing will provide a coverage of vegetation, which will minimise the chance of erosion as a result of runoff. The establishment of pasture on the domains will also limit the amount of fuel load, reducing the impact of potential bushfires.

The pasture covered PMLU may provide a food source for native fauna. The pasture cover will produce seed and flowers throughout the seasons, which may be utilised by native fauna, therefore helping support local ecosystems.

Additionally, other than occasional watering during closure, no further activities would be required to form a stable landform consistent with grazing.

#### **3.3.3.2.4. Economic Benefit**

Establishing grazing pastures will result in a lower cost of direct seeding and a quicker establishment of adequate vegetation cover, potentially leading to an earlier relinquishment of the ML.

Additionally, the future landowners of the Project area will likely be pastoralists as per the surrounding land uses. Rehabilitating RA2 to low-intensity grazing will create additional grazing areas, leading to a direct increase in the economic benefit to the future landholder.

#### **3.3.3.2.5. Social Benefit**

Future landholders will likely be pastoral holdings. Returning the land to grazing pastures will result in a PMLU that is consistent with surrounding land uses.

### **3.3.3.3. RA3 – Dams and Diversion Structures**

RA3 of the Project include diversion drains, sediment dams, PAF runoff dams, infrastructure runoff dams, STP dams, and raw water dams. At this stage there are no formal landholder agreements to retain any dams onsite. As such, water and sediment will be removed from dams and the dams will be filled with NAF or other suitable material. The landform will be shaped to be gently sloping, characteristic of the natural landform with drainage reinstated. The footprint will be ripped and seeded.

#### **3.3.3.3.1. Outcome**

The proposed PMLU for the RA3 is low intensity grazing.

#### **3.3.3.3.2. Environmental Benefit**

The establishment of low intensity grazing will provide a coverage of vegetation, which will minimise the chance of erosion as a result of runoff. The establishment of pasture on the domains will also limit the amount of fuel load, reducing the impact of potential bushfires.

The pasture covered PMLU may provide a food source for native fauna. The pasture cover will produce seed and flowers throughout the seasons, which may be utilised by native fauna, therefore helping support local ecosystems.

Additionally, other than occasional watering during closure, no further activities would be required to form a stable landform consistent with grazing.



#### **3.3.3.3.3. Economic Benefit**

Establishing grazing pastures will result in a lower cost of direct seeding and a quicker establishment of adequate vegetation cover, potentially leading to an earlier relinquishment of Mine Leases.

Future landowners of the Project area will likely be pastoralists as per the surrounding land uses. Rehabilitating to low-intensity grazing will provide an additional grazing area, leading to a direct increase in the economic benefit to the future landholder.

Additionally, other than occasional watering during closure, no further activities would be required to form a stable landform consistent with grazing.

#### **3.3.3.3.4. Social Benefit**

Future landholders will likely be pastoral holdings. Returning the land to grazing pastures will result in a PMLU that is consistent with surrounding land uses.

##### **3.3.3.3.4. RA4 – Mineralised Waste Dumps**

RA4 of the Project includes the PAF waste rock dumps, NAF waste rock dump and the temporary ore stockpile. At the end of mine life, material from the PAF waste rock dump will be returned underground as part of the stope filling. Approximately 0.5m of material will be excavated from the footprint of the PAF waste rock dump and disposed of in the TSF.

NAF waste rock will be removed and used as cover material for the Tailings Storage Facility (TSF). NAF material may also be used to rehabilitate other areas onsite (eg. infill dams). A materials balance is provided in Table 26.

Once the material has been removed, the footprint of each of the WRDs will be graded to conform to the surrounding landscape. Topsoil will be applied at 0.1 - 0.2 m depth and the areas will be ripped and seeded with pasture species.

##### **3.3.3.3.4.1. Outcome**

The proposed PMLU for the RA4 is low intensity grazing.

##### **3.3.3.3.4.2. Environmental Benefit**

The establishment of low intensity grazing will provide a good coverage of vegetation, which will minimise the chance of erosion as a result of runoff. The establishment of pasture on the domains will also limit the amount of fuel load, reducing the impact of potential bushfires.

The pasture covered PMLU may also provide a food source for native fauna. The pasture cover will produce seed and flowers throughout the seasons, which may be utilised by native fauna, therefore helping support local ecosystems.

Additionally, other than occasional watering during closure, no further activities would be required to form a stable landform consistent with grazing.

#### **3.3.3.3.4.3. Economic Benefit**

Establishing grazing pastures will result in a lower cost of direct seeding and a quicker establishment of adequate vegetation cover, potentially leading to an earlier relinquishment of Mine Leases.

Future landowners of the Project area will likely be pastoralists as per the surrounding land uses. Rehabilitating to low-intensity grazing will provide an additional grazing area, leading to a direct increase in the economic benefit to the future landholder.

Additionally, other than occasional watering during closure, no further activities would be required to form a stable landform consistent with grazing.

#### **3.3.3.3.4.4. Social Benefit**

Future landholders will likely be pastoral holdings. Returning the land to grazing pastures will result in a PMLU that is consistent with surrounding land uses.

#### **3.3.3.3.5. RA5 – Mining and Processing Areas**

RA5 of the Project include ROM haul roads, processing plant, sewage treatment plant, battery farm, vehicle maintenance area and laydown yards. To achieve the nominated PMLU, domain infrastructure such as concrete hardstands, buildings, telecommunications, electrical supply etc., will be decommissioned and removed. With infrastructure removed, the landform will be shaped to be a stable, free draining landform. Topsoil will be applied at 0.1 - 0.2 m depth and the areas will be ripped and seeded with pasture species.

##### **3.3.3.3.5.1. Outcome**

The proposed PMLU for the RA5 is low intensity grazing.

##### **3.3.3.3.5.2. Environmental Benefit**

The establishment of low intensity grazing will provide a coverage of vegetation, which will minimise the chance of erosion as a result of runoff. The establishment of pasture on the domains will also limit the amount of fuel load, reducing the impact of potential bushfires.

The pasture covered PMLU may provide a food source for native fauna. The pasture cover will produce seed and flowers throughout the seasons, which may be utilised by native fauna, therefore helping support local ecosystems.

Additionally, other than occasional watering during closure, no further activities would be required to form a stable landform consistent with grazing.

##### **3.3.3.3.5.3. Economic Benefit**

Establishing grazing pastures will result in a lower cost of direct seeding and a quicker establishment of adequate vegetation cover, potentially leading to an earlier relinquishment of Mine Leases.

Future landowners of the Project area will likely be pastoralists as per the surrounding land uses. Rehabilitating to low-intensity grazing will provide an additional grazing area, leading to a direct increase in the economic benefit to the future landholder.

Additionally, other than occasional watering during closure, no further activities would be required to form a stable landform consistent with grazing.

#### **3.3.3.3.5.4. Social Benefit**

Future landholders will likely be pastoral holdings. Returning the land to grazing pastures will result in a PMLU that is consistent with surrounding land uses.

#### **3.3.3.3.6. RA6 – TSF**

RA6 of the Project includes the Tailings Storage Facility and associated pipelines and seepage collection pond.

##### **3.3.3.3.6.1. Outcome**

The proposed PMLU for RA6 is native ecosystem.

The TSF will be capped and revegetated with a mix of shallow rooting native species so as not to compromise the integrity of the sealing layer. The vegetation will act in removing moisture from the infiltration layer and prevent surface ponding and infiltration to subsequent layers of the TSF. Target species include *Aristida latifolia*, *Eriachne obtusa*, *Sporobolus australasicus*, *Themeda triandra* and *Triodia pungens*. The downstream embankment will be reshaped to create a safe, stable and non-polluting landform. Once monitoring indicates the absence of seepage, the seepage collection pond will be rehabilitated, by removing contaminated sediment with the footprint graded, ripped and seeded.

##### **3.3.3.3.6.2. Design**

All infrastructure such as pumps and pipelines will be flushed and removed from site to be disposed of in a licenced waste facility. The final surface of the TSF will be self shedding and will not require major reshaping. The tailings surface will be capped with a low water flux cover system consisting of a capillary break, sealing layer, waste rock layer and revegetated topsoil. The downstream embankment will be reshaped to a gentle slope. Two high capacity spillway channels will be excavated at the northern and southern abutments of the TSF embankment to prevent flood waters passing over the slope of the embankment (ATC Williams, 2015). Full details on the design of the TSF is provided in Appendix B.

##### **3.3.3.3.6.3. Environmental Benefits**

Revegetating with a mix of shallow rooting species will maintain the integrity of the capping layer and prevent potential contamination from tailings. Features such as large woody debris or boulders will be selectively placed to provide suitable habitat for the Purple Neck Rock Wallaby.

##### **3.3.3.3.6.4. Economic Benefit**

The PMLU of native ecosystem does not have a direct economic benefit.

##### **3.3.3.3.6.5. Social Benefit**

The social benefit of re-establishing native ecosystem is the aesthetic appearance and cohesion with the surrounding environment.

### **3.3.3.3.7. RA7 – Renewable Energy Infrastructure**

RA7 incorporates eight wind turbines, ancillary infrastructure such as cabling and meteorological masts, two laydowns and access roads.

#### **3.3.3.3.7.1. Outcome**

The proposed PMLU for RA7 is native ecosystem.

All infrastructure, including turbine components, hardstands, and underground and aboveground cabling, will be decommissioned and removed. All infrastructure will be decommissioned and disposed of in accordance with manufacturer's specifications and waste disposal regulations. No infrastructure will remain within the footprint of the wind farm.

During construction of the turbines, pads are required to be levelled for stability. Hardstands will be constructed for the assembly, construction and erection of the turbines. These hardstands will be retained throughout the life of operations for maintenance and decommissioning purposes. On closure, the hard stands will be removed. Each pad will be recontoured slightly to prevent water ponding. This will prevent water flows from accumulating and concentrating energy to create gullies. No other landform design or earthworks is required.

Revegetation will target species of regional ecosystem 1.11.2a/1.7.7a and RE1.11.3a/1.3.13a consistent with the pre-clearance environment. Target species include *Eucalyptus leucophloia*, *Corymbia terminalis* and *Corymbia capricornia* with a groundcover of *Aristida latifolia*, *Eriachne obtusa*, *Sporobolus australasicus*, *Themeda triandra* and *Triodia pungens*. The target regional ecosystems will support native fauna populations, in keeping with the surrounding habitats. Features such as large woody debris or boulders will be selectively placed to provide suitable refuge for the purple neck rock wallaby.

After infrastructure is removed, the natural landform will remain. Disturbances on the Knapdale Range will not be topsoiled, consistent with the natural profile of the range. The areas will be ripped and seeded with pasture species.

Access roads will be ripped and seeded as above.

#### **3.3.3.3.7.2. Economic Benefit**

The PMLU of native ecosystem does not have a direct economic benefit.

#### **3.3.3.3.7.3. Social Benefit**

The social benefit of re-establishing native ecosystem is the aesthetic appearance and cohesion with the surrounding environment.

### **3.3.3.4. Rehabilitation Milestones**

A Rehabilitation Milestone (RM) is defined as *each significant event or step necessary to rehabilitate the land to a stable condition* (Department of Environment and Science, 2021). Rehabilitation



milestones are used to determine if the rehabilitation area has been rehabilitated to a point that the PMLU has been achieved.

The rehabilitation milestones for each rehabilitation area are outlined below.

**Table 26. PMLU completion criteria**

Rehabilitation milestone	Milestone criteria	Justification of completion criteria	Verification	
RM1	Infrastructure decommissioning and removal	<ul style="list-style-type: none"> <li>a) All buildings and associated infrastructure dismantled and removed offsite</li> <li>b) All hardstand and concrete areas decommissioned and removed</li> <li>c) Fences are removed</li> <li>d) Pipelines (above and below ground) are removed</li> <li>e) Road base removed (with the exception of those being retained for future site access)</li> <li>f) Waste is removed</li> <li>g) Machinery/ equipment not required for rehabilitation is removed from site</li> <li>h) Powerlines (above and below ground) are removed</li> </ul>	<p>Infrastructure is required to be removed from site to enable surface treatment of areas</p>	<p>Documented Inspections</p>
RM2	Remediation of contaminated land	<ul style="list-style-type: none"> <li>a) Contaminated land assessment is completed by a suitably qualified person</li> <li>b) Any identified contaminated material is removed from the mine domain and disposed of at a licenced facility</li> <li>c) Validation sampling determines that contaminant removal has been successful</li> <li>d) The validation sampling report is accepted by a suitably qualified Contaminated Land Auditor stating that contamination removal has been successful</li> </ul>	<ul style="list-style-type: none"> <li>• Contaminated material is required to be removed to minimise potential for environmental harm</li> <li>• A validation report will provide verification that contaminants have been removed and landform shaping can commence</li> </ul>	<ul style="list-style-type: none"> <li>• Preliminary Site Investigation Report</li> <li>• Detailed Site Investigation Report</li> <li>• Validation Investigation Report</li> </ul>

Rehabilitation milestone	Milestone criteria	Justification of completion criteria	Verification
RM3	Landform development and reshaping / re-profiling (RA1)	<ul style="list-style-type: none"> <li>a) Landform is shaped to be gently sloping, characteristic of the natural landform with natural drainage lines reinstated</li> <li>b) Landform is ripped parallel to landform</li> <li>c) Features such as large woody debris or boulders are present to provide suitable habitat for the Purple Neck Rock Wallaby</li> <li>d) RA1 is determined to be geotechnically stable by a suitably qualified geotechnical engineer</li> </ul>	<ul style="list-style-type: none"> <li>• The final landform must be consistent with the surrounding land and profiled to limit erosion</li> <li>• RA1 has been designated as a native ecosystem and therefore needs to support fauna populations</li> </ul>
RM4	Landform development and reshaping / re-profiling (RA2)	<ul style="list-style-type: none"> <li>a) Landform is shaped to be gently sloping, characteristic of the natural landform with natural drainage lines reinstated</li> <li>b) Landform is ripped parallel to landform</li> <li>c) RA2 determined to be geotechnically stable by a suitably qualified geotechnical engineer</li> </ul>	<ul style="list-style-type: none"> <li>• The final landform must be consistent with the surrounding land and profiled to limit erosion</li> </ul>
RM5	Landform development and reshaping / re-profiling (RA3)	<ul style="list-style-type: none"> <li>a) General earthworks completed</li> <li>b) HPDE Liner removed</li> <li>c) Dams filled with NAF or other suitable material. Material is placed in 500mm lifts, watered and compacted</li> <li>d) Landform is shaped to be gently sloping, characteristic of the natural landform with natural drainage lines reinstated</li> </ul>	<ul style="list-style-type: none"> <li>• The final landform must be consistent with the surrounding land and profiled to limit erosion</li> </ul>

Rehabilitation milestone	Milestone criteria	Justification of completion criteria	Verification
		e) RA3 is determined to be geotechnically stable by a suitably qualified geotechnical engineer	
RM6	Landform development and reshaping / re-profiling (RA4 / RA5)	a) Waste rock is removed from surface. PAF is disposed underground. NAF utilised in rehabilitation b) Major earthworks are completed c) Landform is shaped to be gently sloping, characteristic of the natural landform with natural drainage lines reinstated d) RA4/5 is determined to be geotechnically stable by a suitably qualified geotechnical engineer	The final landform must be consistent with the surrounding land and profiled to limit erosion <ul style="list-style-type: none"> <li>• Survey</li> <li>• Certification reporting from a suitably qualified person</li> </ul>
RM7	Landform development and reshaping (RA6)	a) The construction of the cover system / cap has been certified by an appropriately qualified person as being consistent with the cover design b) QAQC testing is completed post construction at a rate of at least 1 sample per ha and confirms the depth of layers and permeability is to specified designs and no PAF material is present within the cover system c) Primary monitoring locations have been established in representative locations recommended as an outcome of the trial mentioned in Condition PRCP5(e) and include: <ol style="list-style-type: none"> <li>I. An automated meteorological station that records the following:               <ol style="list-style-type: none"> <li>i. rainfall (tipping bucket),</li> <li>ii. evaporation,</li> </ol> </li> </ol>	<ul style="list-style-type: none"> <li>• The final landform has been designed to shed water and provide stable slopes</li> <li>• RA6 has been designated as a native ecosystem and therefore needs to support fauna populations</li> <li>• Excessive rilling is unlikely to</li> </ul>



Rehabilitation milestone	Milestone criteria	Justification of completion criteria	Verification
		<ul style="list-style-type: none"> <li>iii. relative humidity,</li> <li>iv. wind strength,</li> <li>v. wind direction, and</li> <li>vi. air temperature.</li> </ul> <ul style="list-style-type: none"> <li>II. piezometers within the tailings and capillary break layer,</li> <li>III. automated in situ water content and suction sensors in each layer of the cover system and in the tailings below the cover system that records data at 30 minute intervals (except in the capillary break),</li> <li>IV. temperature sensor in each layer of the cover system and in the tailings below the cover system that records data at 30 minute intervals,</li> <li>V. a lysimeter.</li> </ul> <p>d) Secondary monitoring locations have been established in representative locations recommended as an outcome of the trial mentioned in Condition PRCP5(e) and include in each layer of the cover system and in the tailings below the cover system:</p> <ul style="list-style-type: none"> <li>I. piezometers within the tailings and capillary break layer,</li> <li>II. automated in situ water content sensors in each layer of the cover system and in the tailings below the cover system that records</li> </ul>	<p>occur at erosion rates of &lt;5t/ha/y</p> <ul style="list-style-type: none"> <li>• Erosion rilling &lt;0.2m will prevent exposure of tailings</li> </ul>

Rehabilitation milestone	Milestone criteria	Justification of completion criteria	Verification
		<p>data at 30 minute intervals (except in the capillary break).</p> <ul style="list-style-type: none"> <li>e) Temperature sensor in each layer of the cover system and in the tailings below the cover system that records data at 30 minute intervals. All sensors are calibrated to each material type using the manufacturers specifications</li> <li>f) Lysimeters and associated drainage collection and monitoring system are installed in at least 3 locations that are recommended as an outcome of the trial mentioned in Condition PRCP5(e)</li> <li>g) Sediment capture flumes have been installed and calibrated at the base of the TSF embankment</li> <li>h) All monitoring equipment has been installed and calibrated by an appropriately qualified person</li> <li>i) Slopes of TSF top to have a grade of 1% with slope lengths of ~2000m at the southern end of the TSF, and 1150m at the northern end</li> <li>j) Certification by an AQP that landform has been constructed according to the design and has achieved an acceptable factor of safety</li> <li>k) Main TSF embankment formed as a broad spillway rock chute with slopes of 15% with a slope length of ~230 m</li> <li>l) TSF is assessed as geotechnically stable by a suitably qualified geotechnical engineer</li> </ul>	

Rehabilitation milestone	Milestone criteria	Justification of completion criteria	Verification	
		<p>m) Features such as large woody debris or boulders are present to provide suitable habitat for the Purple Neck Rock Wallaby</p> <p>n) TSF surface has been shaped to prevent ponding and concentration of surface water flow</p> <p>o) Spillway is designed and constructed to support peak flood flow velocity</p> <p>p) An average erosion rate &lt;5 t/ha/y</p> <p>q) Erosion rilling is &lt;0.2m</p> <p>r) No surface ponding</p> <p>s) Installation of erosion and sediment control structures that comply with International Erosion Control Association (IECA)</p>		
RM8	Landform development and reshaping (RA7)	<p>a) Where erosion risk is identified, pad crests are rounded to create convex slope profile.</p> <p>b) Locally stockpiles material from road and drainage development is respread</p>	<ul style="list-style-type: none"> <li>Minimise surface flows and gully erosion</li> </ul>	<ul style="list-style-type: none"> <li>Documented Inspections</li> <li>Survey</li> </ul>
RM9	Surface preparation	<p>a) Deep ripping of compacted surfaces, at least 300mm into soil profile, where required and avoiding habitat features associated with RM3</p> <p>b) An assessment of the need for soil amelioration undertaken and soil ameliorants such as fertiliser, gypsum and/or organic matter have been applied at rates determined by an appropriately qualified person</p> <p>c) Topsoil placement of a minimum 0.1 - 0.2 m, where required</p>	<ul style="list-style-type: none"> <li>Ripping and application of growth media will encourage establishment of vegetation</li> </ul>	<ul style="list-style-type: none"> <li>Survey</li> <li>Certification reporting from a suitably qualified person</li> </ul>

Rehabilitation milestone	Milestone criteria	Justification of completion criteria	Verification	
RM10	Revegetation (native ecosystem)	<ul style="list-style-type: none"> <li>a) Seeding rate of 4 – 10 kg/ha is applied</li> <li>b) Direct seeding species mix is endemic to Regional Ecosystem 1.11.2 and 1.7.7 on RA1 including <i>Eucalyptus leucophloia</i>, <i>Corymbia terminalis</i>, <i>Corymbia capricornia</i> with a groundcover of <i>Aristida latifolia</i>, <i>Eriachne obtusa</i>, <i>Sporobolus australasicus</i>, <i>Themeda triandra</i>, <i>Triodia pungens</i></li> <li>c) Direct seeding species mix is endemic to Regional Ecosystem 1.11.2 and 1.7.7 on RA6 including <i>Aristida latifolia</i>, <i>Eriachne obtusa</i>, <i>Sporobolus australasicus</i>, <i>Themeda triandra</i>, <i>Triodia pungens</i>.</li> <li>d) Direct seeding species mix is endemic to Regional Ecosystem 1.11.2a/1.7.7a and RE1.11.3a/1.3.13a on RA7, including <i>Eucalyptus leucophloia</i>, <i>Corymbia terminalis</i> and <i>Corymbia capricornia</i> with a groundcover of <i>Aristida latifolia</i>, <i>Eriachne obtusa</i>, <i>Sporobolus australasicus</i>, <i>Themeda triandra</i> and <i>Triodia pungens</i>.</li> <li>e) Deep rooting vegetation such as <i>Eucalyptus</i> spp not present on RA6</li> <li>f) Groundcover &gt;50%</li> </ul>	<ul style="list-style-type: none"> <li>• Monitoring will assess success of natural revegetation and determine if intervention measures are required eg. further application of seed is required</li> <li>• Vegetation species have been selected based on pre mine Regional Ecosystems</li> <li>• Deep rooting species present a risk of exposing capped tailings on RA6</li> </ul>	<ul style="list-style-type: none"> <li>• BioCondition Assessment Report</li> <li>• Annual REMP report</li> <li>• Laboratory Certificates of Analysis (COAs)</li> <li>• Annual Rehabilitation Monitoring Report</li> </ul>



Rehabilitation milestone	Milestone criteria	Justification of completion criteria	Verification	
RM11	Revegetation (grazing)	<ul style="list-style-type: none"> <li>a) Pasture vegetation seeding creates cover &gt;30%</li> <li>b) Direct seeding of native species including Eucalyptus leucophloia, Corymbia capricornia, Terminalia aridicola, Corymbia terminalis, Triodia pungens, Eucalyptus pruinose, Eremophila longifolia, Atalaya hemiglauca, Acacia chisholmi, Atalaya hemiglauca, Carissa lanceolata as well as appropriate 3P grass species to support the PMLU</li> <li>c) Direct seeding is applied at a rate of 4 – 10 kg/ha</li> </ul>	<ul style="list-style-type: none"> <li>• Monitoring will assess success of natural revegetation and determine if intervention measures are required eg. further application of seed is required</li> <li>• Vegetation species have been selected based on PMLU of grazing</li> </ul>	<ul style="list-style-type: none"> <li>• BioCondition Assessment Report</li> <li>• Annual REMP report</li> <li>• Laboratory Certificates of Analysis (COAs)</li> <li>• Annual Rehabilitation Monitoring Report</li> </ul>
RM12	Achievement of surface requirements (native ecosystem)	<p>For all areas:</p> <ul style="list-style-type: none"> <li>a) Weed species in densities less than 10% total coverage</li> <li>b) Average erosion rate of &lt;5 t/ha/y</li> <li>c) Vegetation cover 70%</li> <li>d) Species used in revegetation in RM 9 remain present and showing evidence of natural recruitment</li> <li>e) Surface water quality measured at downstream monitoring sites (CT3-08 (MS2), CC-05, CC-15, MS8 (SN-15), SC-29 (MS5) and DR-18) undertaken on an</li> </ul>	<ul style="list-style-type: none"> <li>• Excessive rilling is unlikely to occur at erosion rates of &lt;5t/ha/y</li> <li>• Surface water values have been selected based on the Projects classification as slightly to</li> </ul>	<ul style="list-style-type: none"> <li>• BioCondition Assessment Report</li> <li>• Annual REMP report</li> <li>• Laboratory Certificates of Analysis (COAs)</li> <li>• Annual Rehabilitation Monitoring Report</li> </ul>

Rehabilitation milestone	Milestone criteria	Justification of completion criteria	Verification	
		<p>event basis1 complies with ANZECC/ARMCANZ (2000) Table 3.4.1 for 95% protection level and Table 3.3.4 values for aquatic ecosystems (slightly to moderately disturbed)</p> <p>f) Stream sediment quality at downstream monitoring sites (CT3-08 (MS2), CC-05, CC-15, MS8 (SN-15), SC-29 (MS5) and DR-18) undertaken twice a year (at end of wet season and end of dry season) complies with ANZECC/ARMCANZ (2000) Interim Sediment Quality Guidelines – low</p> <p>g) Quarterly groundwater monitoring at MB5, MB6, MB9S and MB9D demonstrate groundwater quality complies with groundwater trigger limits nominated in Schedule C – Table 8 of the EA</p> <p>h) Soil testing indicates the following parameters are met:</p> <ol style="list-style-type: none"> <li>I. Rootzone EC &lt;0.15mS/cm,</li> <li>II. Soil pH &lt;9 and &gt;6 as measured at any part of the root zone,</li> <li>III. Exchangeable Sodium Percentage (ESP%) &lt;5% (at 0-10cm depth).</li> </ol> <p>For RA6:</p> <p>i) There is no evidence of water ponding on the surface of the TSF</p>	<p>moderately disturbed</p> <ul style="list-style-type: none"> <li>• Livestock drinking water values have been selected based on surrounding land use of grazing</li> <li>• Monitoring sites have been selected to capture all areas of disturbance, including downstream of the TSF</li> <li>• Soil parameters are consistent with pre-mine condition</li> <li>• TSF seepage is expected to decrease after rehabilitation</li> </ul>	

Rehabilitation milestone	Milestone criteria	Justification of completion criteria	Verification
		<ul style="list-style-type: none"> <li>j) Continuous recording demonstrates seepage volume is decreasing</li> <li>k) Seepage is collected and disposed of at an appropriately licensed facility</li> <li>l) In-situ permeability and surface infiltration are not significantly decreasing compared with initial rates based on statistical analysis</li> </ul>	<ul style="list-style-type: none"> <li>• RA will be compared to reference sites to account for seasonal fluctuations</li> </ul>
RM13	Achievement of surface requirements (grazing)	<ul style="list-style-type: none"> <li>a) Weed species in densities less than 10% total coverage</li> <li>b) Pasture covers has reached 70% of surface area</li> <li>c) Average erosion rate of &lt;5 t/ha/y with the maximum erosion rate at any point on the landform of &lt;10 t/ha/y</li> <li>d) Surface water quality measured at downstream monitoring sites (CT3-08 (MS2), CC-05, CC-15, MS8 (SN-15), SC-29 (MS5) and DR-18) undertaken on an event basis complies with ANZECC/ARMCANZ (2000) Table 3.4.1 for 95% protection level and Table 3.3.4 values for aquatic ecosystems (slightly disturbed)</li> <li>e) Stream sediment quality at downstream monitoring sites (CT3-08 (MS2), CC-05, CC-15, MS8 (SN-15), SC-29 (MS5) and DR-18) undertaken twice a year (at end of wet season and end of dry season) complies with ANZECC/ARMCANZ (2000) Interim Sediment Quality Guidelines – low</li> <li>f) Quarterly groundwater monitoring at MB5, MB6, MB9S and MB9D demonstrates groundwater quality</li> </ul>	<ul style="list-style-type: none"> <li>• Site specific vegetation completion criteria will be determined based on reference site monitoring</li> <li>• Excessive rilling is unlikely to occur at erosion rates of &lt;5t/ha/y</li> <li>• Surface water values have been selected based on the Projects classification as slightly to</li> </ul> <ul style="list-style-type: none"> <li>• BioCondition Assessment Report</li> <li>• Annual REMP report</li> <li>• Laboratory Certificates of Analysis (COAs)</li> <li>• Annual Rehabilitation Monitoring Report</li> </ul>

Rehabilitation milestone	Milestone criteria	Justification of completion criteria	Verification
		<p>complies with groundwater trigger limits nominated in Schedule C – Table 8 of the EA</p> <p>g) Soil testing indicates the following parameters are met:</p> <ol style="list-style-type: none"> <li>I. Rootzone EC &lt;0.15mS/cm,</li> <li>II. Soil pH &lt;9 and &gt;6 as measured at any part of the root zone,</li> <li>III. Exchangeable Sodium Percentage (ESP%) &lt;5% (at 0-10cm depth).</li> </ol>	<p>moderately disturbed</p> <ul style="list-style-type: none"> <li>• Livestock drinking water values have been selected based on surrounding land use of grazing</li> <li>• Monitoring sites have been selected to capture all areas of disturbance, including downstream of the TSF</li> <li>• Soil parameters are consistent with pre-mine condition</li> <li>• TSF seepage is expected to decrease after rehabilitation</li> </ul>



Rehabilitation milestone	Milestone criteria	Justification of completion criteria	Verification
			<ul style="list-style-type: none"> <li>RA will be compared to reference sites to account for seasonal fluctuations</li> </ul>
RM14	Achievement of post-mining land use to a stable condition (native ecosystem)	<p>For all areas:</p> <ul style="list-style-type: none"> <li>a) Vegetation cover exceeds 70% of the surface area</li> <li>b) All species used in RM9 show natural recruitment</li> <li>c) Weed species in densities less than 10% total coverage</li> <li>d) Native fauna observed or indicators of these species have been recorded</li> <li>e) There is no evidence of seepage occurring within the mining tenure</li> <li>f) Certification from an REPQ that the domain has achieved stable condition</li> <li>g) Certification from an AQP that the landform achieved a factor of safety 1.5</li> <li>h) All results from surface water quality measured at downstream monitoring sites (CT3-08 (MS2), CC-05, CC-15, MS8 (SN-15), SC-29 (MS5) and DR-18) undertaken on an event basis complies with ANZECC/ARMCANZ (2000) Table 3.4.1 for 95% protection level and Table 3.3.4 values for aquatic</li> </ul>	<ul style="list-style-type: none"> <li>Site specific vegetation completion criteria will be determined based on reference site monitoring</li> <li>Excessive rilling is unlikely to occur at erosion rates of &lt;5t/ha/y</li> <li>Surface water values have been selected based on the Projects classification as slightly to moderately disturbed</li> </ul> <ul style="list-style-type: none"> <li>BioCondition Assessment Report</li> <li>Annual REMP report</li> <li>Laboratory Certificates of Analysis (COAs)</li> <li>Annual Rehabilitation Monitoring Report</li> </ul>

Rehabilitation milestone	Milestone criteria	Justification of completion criteria	Verification
	<p>ecosystems (slightly disturbed) for a minimum of 5 consecutive years</p> <p>i) All results from stream sediment quality at downstream monitoring sites (CT3-08 (MS2), CC-05, CC-15, MS8 (SN-15), SC-29 (MS5) and DR-18) undertaken twice a year (at end of wet season and end of dry season) complies with ANZECC/ARMCANZ (2000) Interim Sediment Quality Guidelines – low for a minimum of 5 consecutive years</p> <p>j) All results from quarterly groundwater monitoring at MB5, MB6, MB9S and MB9D demonstrate groundwater quality complies with groundwater trigger limits nominated in Schedule C – Table 8 of the EA for a minimum of 5 consecutive years</p> <p>k) Soil testing undertaken at yearly intervals indicates the following parameters are met:</p> <ol style="list-style-type: none"> <li>I. Rootzone EC &lt;0.15mS/cm,</li> <li>II. Soil pH &lt;9 and &gt;6 as measured at any part of the root zone,</li> <li>III. Exchangeable Sodium Percentage (ESP%) &lt;5% (at 0-10cm depth).</li> </ol> <p>For RA1:</p> <p>l) No evidence of erosion classified as ‘Severe’</p>	<ul style="list-style-type: none"> <li>• Livestock drinking water values have been selected based on surrounding land use of grazing</li> <li>• Monitoring sites have been selected to capture all areas of disturbance, including downstream of the TSF</li> <li>• Soil parameters are consistent with pre-mine condition</li> <li>• TSF seepage is expected to decrease after rehabilitation</li> <li>• RA will be compared to</li> </ul>	

Rehabilitation milestone	Milestone criteria	Justification of completion criteria	Verification
		<p>m) No active erosion present as demonstrated by no increase in erosion ratings over time</p> <p>For RA6:</p> <p>n) There is no evidence of water ponding on the surface of the TSF</p> <p>o) Average erosion rate of &lt;5 t/ha/y</p> <p>p) No evidence of erosion classified as 'moderate' or 'severe'</p> <p>q) No evidence of salt rise through the cover system of the TSF</p> <p>r) In-situ permeability and surface infiltration are not significantly decreasing compared with initial rates based on statistical analysis</p> <p>s) Results of monitoring gathered from primary and secondary monitoring stations established in RM7 demonstrate the following has been maintained for a minimum of 10 years:</p> <ul style="list-style-type: none"> <li>I. Hydraulic conductivity of the cover system is less than <math>1 \times 10^{-8}</math> m/s for at least 10 years,</li> <li>II. Net percolation through the cover into the tailings has been reduced to &lt;5% of rainfall for at least 10 years as measured by primary and secondary monitoring locations and lysimeters,</li> </ul>	<p>reference sites to account for seasonal fluctuations</p>

Rehabilitation milestone	Milestone criteria	Justification of completion criteria	Verification
		III. Water content of the reduced permeability layer is maintained above 85% over a 10 year period, IV. Temperature within the tailings has not increased over a 10 year period, V. Volumetric water content of tailings does not respond to rainfall events.	
RM15	Achievement of PMLU to a stable condition (grazing)	a) Weed species in densities less than 10% total coverage b) Vegetation cover has reached 70% c) All established species show natural recruitment d) Land suitability assessment by an appropriately qualified person certifies land has achieved a post-mine land suitability of 4 or better e) Minimum of 4 palatable perennial pasture species and 2 shade tree species established f) No evidence of erosion classified as 'Severe' g) No active erosion present as demonstrated by no increase in erosion ratings over time h) There is no evidence of seepage occurring within the mining tenure i) Certification from an REPQ that the domain has achieved stable condition j) Certification from an AQP that the landform achieved a factor of safety 1.5	<ul style="list-style-type: none"> <li>• Site specific vegetation completion criteria will be determined based on reference site monitoring</li> <li>• Excessive rilling is unlikely to occur at erosion rates of &lt;5t/ha/y.</li> <li>• Certification from a AQP is required for relinquishment</li> <li>• Surface water values have been selected based</li> </ul> <ul style="list-style-type: none"> <li>• BioCondition Assessment Report</li> <li>• Annual REMP report</li> <li>• Laboratory Certificates of Analysis (COAs)</li> <li>• Annual Rehabilitation Monitoring Report</li> </ul>



Rehabilitation milestone	Milestone criteria	Justification of completion criteria	Verification
	<p>k) All results from surface water quality measured at downstream monitoring sites (CT3-08 (MS2), CC-05, CC-15, MS8 (SN-15), SC-29 (MS5) and DR-18) complies with ANZECC/ARMCANZ (2000) Table 3.4.1 for 95% protection level and Table 3.3.4 values for aquatic ecosystems (slightly to moderately disturbed) for a minimum of 5 consecutive years</p> <p>l) All results from stream sediment at downstream monitoring sites (CT3-08 (MS2), CC-05, CC-15, MS8 (SN-15), SC-29 (MS5) and DR-18) undertaken twice a year (at end of wet season and end of dry season) complies with limits set for low risk and no adverse effects in ANZECC/ARMCANZ (2000) Interim Sediment Quality Guidelines – low for a minimum of 5 consecutive years</p> <p>m) All results from quarterly groundwater monitoring at MB5, MB6, MB9S and MB9D demonstrate groundwater quality complies with groundwater trigger limits nominated in Schedule C – Table 8 of the EA for a minimum of 5 consecutive years</p> <p>n) Soil testing undertaken at yearly intervals indicates the following parameters are met:</p> <ol style="list-style-type: none"> <li>I. PAWC &gt;50 at Red Plain and Pocket soil types,</li> <li>II. Rootzone EC &lt;0.15mS/cm,</li> </ol>	<p>on the Projects classification as slightly to moderately disturbed</p> <ul style="list-style-type: none"> <li>• Livestock drinking water values have been selected based on surrounding land use of grazing</li> <li>• Monitoring sites have been selected to capture all areas of disturbance, including downstream of the TSF</li> <li>• Soil parameters are consistent with pre-mine condition</li> </ul>	

Rehabilitation milestone	Milestone criteria	Justification of completion criteria	Verification
	<p>III. Soil pH &lt;9 and &gt;6 as measured at any part of the root zone,</p> <p>IV. Exchangeable Sodium Percentage (ESP%) &lt;5% (at 0-10cm depth),</p> <p>V. Carrying capacity is suitable to support a sustainable level of grazing.</p>	<ul style="list-style-type: none"> <li>• TSF seepage is expected to decrease after rehabilitation</li> <li>• RA will be compared to reference sites to account for seasonal fluctuations</li> </ul>	

### **3.4. Non-use management areas**

There are no non-use management areas proposed for the Project.

### **3.5. Rehabilitation and Management Methodologies**

#### **3.5.1. Voids in Floodplains**

There are no proposed voids associated with the Project.

#### **3.5.2. General rehabilitation principles**

##### **3.5.2.1. Site Services**

To ensure site safety, all services will be terminated, disconnected and isolated. Generators will be decommissioned and removed from site. Power substations will be removed, or sold or used as part of another project, and the switch room will be disconnected. Licenced contractors will remove sewerage to a licensed offsite facility. Telecommunication services will be disconnected and removed.

The infrastructure at the Project site will be decommissioned, removed, dismantled, or salvaged.

##### **3.5.2.2. Contaminated land assessment**

A contaminated land assessment is to be completed by a suitably qualified person, at all rehabilitation areas. Any contaminated material will be removed and disposed at a licenced. Validation sampling will be completed to determine if the contaminant removal has been completed appropriately.

##### **3.5.2.3. Site Preparation**

Once all infrastructure and any contaminated material has been removed, the surface will be prepared to promote establishment of vegetation. Compacted surfaces will be deeply ripped to at least 300 mm into the soil profile, avoiding habitat features related to the PNRW.

##### **3.5.2.4. Soil Capping and Material Assessment**

The materials required to successfully rehabilitate certain mine domains include topsoil and inert material (such as NAF waste rock). These materials shall provide armour between potential contaminants and supplement the growth of vegetation, reducing erosion and helping to sustain the PMLU. Material for rehabilitation will be sourced from site at locations shown in Figure 14. A preliminary materials balance is provided in Table 26. These volumes will continue to be finalised as the mine plan is updated and rehabilitation commences.

**Table 26 Preliminary Materials Balance**




RA	Area (ha)	Volume of topsoil required (m <sup>3</sup> ) (assumed 50% coverage)	Volume of NAF required
RA1	30.3	0	0
RA2	43.34	0	0
RA3	41.60	41,600	0
RA4	20.20	20,200	0
RA5	201.59	201,590	0
RA6	216.9	216,900	970,140
RA7	68.35	0	0
Total		480,290	970,140
Available		126,842	TBA <sup>1</sup>

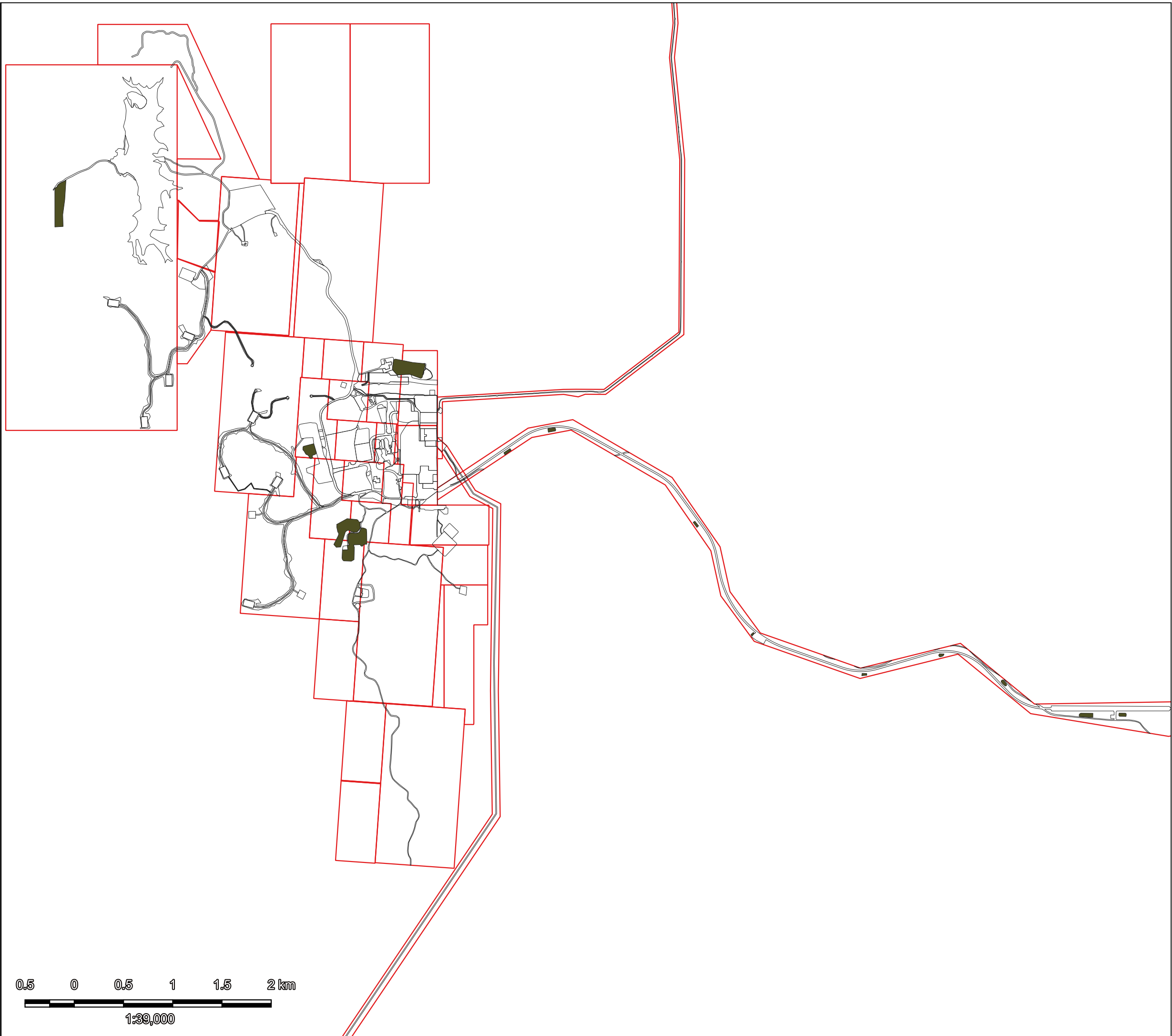
<sup>1</sup> Materials balance under review

**Figure 14. Available Material**

**Legend**

**Domains**

-  Borrow Pit/Stockpile
-  Other
-  Mine Lease



Client: Minerals and Metals Group  
Project number: 2023.07002  
CRS: WGS 84 / Pseudo-Mercator EPSG:3857  
Date: 27 July 2023  
Print as A3

**Disclaimer:**  
Whilst every effort and care has been taken to ensure the accuracy of this report, Wulguru Technical Services Pty Ltd makes no representations or warranties about its accuracy, reliability, completeness or suitability for any particular purpose and disclaims all responsibility and all liability (including without limitation, liability in negligence) for all expenses, losses, damages (including indirect or consequential damage) and costs which you might incur as a result of the product being inaccurate or incomplete in any way and for any reason.  
Digital data for this report is available on the Queensland Government Spatial Portal at <https://qldspatial.information.qld.gov.au>.





### 3.5.2.5. Topsoil Management

#### 3.5.2.5.1. Topsoil Striping

Where available, topsoil was stripped during the construction phase of the project. Topsoil is currently stockpiled at locations shown on Figure 14.

Prior to new ground disturbance, topsoil is stripped and added to one of the existing stockpiles. Stockpiles are surveyed annually, and the total volume is recorded in the Topsoil Stockpile Register.

**Table 27. Stockpiles Topsoil Volumes**

Stockpile category	Description	Volume (m <sup>3</sup> )
TsH	High quality soil, almost entirely covered by regrowth, with high species diversity.	0
TsM	Medium quality soil with moderate regrowth visible and some species diversity.	5,003
TsL	Low quality soil, combined with subsoil, with some regrowth visible.	80,858
SkS	Skeletal soil (abundant rocks) with little to no regrowth.	35,329
Vg	Predominately vegetation stockpiles	5,652
<b>Total</b>		<b>126,842</b>

#### 3.5.2.5.2. Topsoil Stockpiling

Once stripped, topsoil is stored at a maximum height of 2m, and only in locations that have been previously designated by site plans. A register of topsoil stockpiles is kept and maintained on-site, recording stockpile number, placement date, source location, soil type, and any relevant comments. Stockpiles are designed and located to minimise topsoil loss through runoff and erosion and are marked and identifiable with signage. Active stockpiles are inspected as part of ongoing environmental inspections.

Due to the long life of the operation, topsoil condition is better assessed closer to its application. An assessment will be conducted to identify the need for soil amelioration such as fertilizer, gypsum and/or organic matter. The results of the analysis will determine if any ameliorants are required and the application rate.

#### 3.5.2.5.3. Topsoil Application

The Project is partially located on the rocky scarps of the Knapdale Range. The Knapdale soil management unit and Miners soil management unit is described as being shallow rocky soils. Similarly, the Red Plains, Prospectors and Pocket soil management units are described as being shallow soils.

Disturbances located on the Knapdale range will be ripped and seeded with no topsoil application. Where required, topsoil will be applied at high risk areas such as the TSF and processing areas. Topsoil will be placed in strips approximately 5m in width, 0.1 – 0.2 m deep to maximise application.

### **3.5.2.6. Erosion and Sediment Control**

Erosion and sediment control measures will be implemented in accordance with the Best Practice Erosion and Sediment Control, published by the Australasian International Erosion Control Association (IECA). Revegetation will minimise erosion and act as a sediment control, and ensure landforms are both geochemically and physically stable.

Effective erosion and sediment control structures were installed during the operational phase of the project. An allowance has been made to retain four additional sediment controls post mine closure, with some minor earthworks required to ensure these controls are safe and effective. The site runoff dam is the primary sediment control on the Project. Site affected water will continue to be directed to this structure whilst closure activities are in progress.

Erosion and sediment control plans will be considered when conducting rehabilitation activities, and should include the following:

- Contours and drainage lines;
- Disturbance limits;
- Earthwork extents;
- Control measure locations;
- Order of work schedule;
- Construction details and notes; and
- Specific operating procedures.

### **3.5.2.7. Revegetation**

Surfaces will be ripped to a depth of 300 mm, where practical, and allowed to revegetate naturally. If annual monitoring identifies that natural revegetation has not been successful (natural vegetation strike <30% surface coverage compared to reference site), areas will be seeded with appropriate plant species. Plant species have been selected considering the pre clearance regional ecosystem (RA1-RA5, RA7) as well as the integrity of tailings cap (RA6). The proposed target species are provided in Table 28.. When possible, areas will be seeded directly with selected species. Where direct seeding is not possible, seeds will be manually broadcast.

Rehabilitation areas will be fenced to prevent access to cattle whilst vegetation establishes. Cattle will only be permitted to graze once the achievement of surface requirements (RM13) has been certified. Fire breaks will be maintained and weed management controls will be implemented as required, to ensure success of revegetation.

**Table 28. Vegetation seed mix**

	RA1	RA2, RA3, RA4, RA5, RA7	RA6
<b>Target Regional Ecosystem</b>	1.11.2a/1.7.7a	1.11.2a, 1.11.2a/ 1.5.13/ 1.3.7b.	1.11.3a/1.3.13a, 1.11.2a/1.7.7a.
Dominant species	<i>Eucalyptus leucophloia</i>	<i>Eucalyptus leucophloia</i>	<i>Triodia pungens</i>
	<i>Corymbia capricornia</i>	<i>Corymbia capricornia</i>	<i>Eriachne obtusa</i>
	<i>Terminalia aridicola</i>	<i>Terminalia aridicola</i>	<i>Sporobolus australasicus</i>
	<i>Carissa lanceolata</i>	<i>Corymbia terminalis</i>	<i>Themeda triandra</i>
	<i>Triodia pungens</i>	<i>Triodia pungens</i>	<i>Aristida latifolia</i>
	<i>Sporobolus australasicus,</i>	<i>Eucalyptus pruinosus</i>	
	<i>Themeda triandra</i>	<i>Eremophila longifolia</i>	
	<i>Eriachne obtusa,</i>	<i>Atalaya hemiglauca</i>	
	<i>Corymbia terminalis</i>	<i>Acacia chisholmii</i>	
	<i>Aristida latifolia</i>	<i>Atalaya hemiglauca</i>	
		<i>Carissa lanceolata</i>	

### 3.5.2.8. Weed Management

Weed hygiene practices will be implemented at all stages of closure. All mobile plant, machinery, heavy vehicles and earthmoving equipment will be inspected upon entry to site. If weeds or seeds are identified, vehicles and equipment will be cleaned in the site washbay.

Weed density will be monitored as part of rehabilitation monitoring, and appropriate treatment controls will be implemented as required. It is anticipated that the focus of the weed control program would be the management of Cabbage Tree (*Calotropis procera*) due to its potential toxic effect on grazing cattle.

### 3.5.2.9. Water management

The water management strategy for the Project aims to separate clean stormwater from potentially affected site water. Structures such as runoff dams and sediment dams will be retained onsite whilst rehabilitation works are occurring. Controlled releases of water will occur when required and when water quality meets the release criteria stipulated in the EA.

Closure objectives for the Project stipulate final landforms are to be geochemically stable and will not generate seepage or leach to surface water or groundwater. Ongoing monitoring of TSF seepage rates and quality, along with regular surface and groundwater monitoring will guide further works. Contaminated land validation sampling will verify that contaminated material has been removed or if additional work is required to prevent the release of contaminants to waters.

### **3.5.2.10. Flooding**

Flood modelling completed for the project indicates that the mining operations and infrastructure are located above the Dugald River and Silver Creek 100-year ARI flood levels (WRM, 2010). Whilst the operations would not be impacted by flooding, the main access road from the Burke Developmental Road is susceptible to flooding at four locations. Due to the design of the crossings, the road would be overtopped whenever a significant runoff event occurs. The risk of flooding is not expected to impact upon the success of rehabilitation activities.

Flood mapping (ATC Williams, 2021) shows that the mine portals are not located below the 0.1% AEP flood level and are therefore not located within the floodplain. Further, both portals are at very low risk from flooding. The North Portal and the South Portal are not subject to inundation in any events up to and including the probable maximum flood (PMF). Additionally, the mine portals will be capped at closure, to prevent water entering the mine workings.

Post closure, the TSF will be the only remaining built landform, although this will be closed and capped. The preliminary design has adopted a self-shedding cover system, with a nominal gradient of 1.5%, and a modified embankment. A spillway channel will be added, to achieve the following:

- Prevent water from ponding against the upstream face of the embankment;
- Prevent flow over the top of the embankment;
- Divert flows away from the toe of the embankment; and
- Reconnect catchment flows with the downstream watercourse.

The flood modelling demonstrates that the proposed spillway design is suitable to safely convey events up to and including the PMF. Additional engineering design activities will be undertaken to ensure the spillway channel accommodates the peak flood flow velocity (predicted to be 6.2 m/s) so as to achieve a stable spillway condition.

There are no voids or water containment structures proposed to be retained on closure, therefore there is no risk of flooding of such structures.

The flood modelling is presented in Appendix F.

### **3.5.2.11. Subsidence management**

The Project employs a sub level open stope mining method with both cemented and rock backfill. This method increases the long-term stability of the mine and ensures consolidation of voids.

DRM completed a geotechnical study (Appendix C) on surface subsidence risk and the implications for closure. The study found that the risk of surface subsidence is low. The Project has a shallow weathering profile and shallow ground water, therefore there is minimal influence of groundwater on the underground stability and crown pillar stability (MMG, 2020). All stopes extracted underground have limited stope strikes and are cable bolted to increase the short-term stability and are all backfilled with either waste rock or cemented backfill to ensure long term stability and confinement of voids to prevent long term subsidence (MMG, 2020). Surface subsidence will continue to be monitored throughout the life of the operations.

### **3.5.3. Waste characterisation**

Three waste rock characterisation studies have been completed at the project to date. The three studies (AGC Woodward-Clyde, 1991), (AARC, 2008), and (EGi, 2010) provide a combined total of 211 samples across the seven lithologies (Table 29).

#### **3.5.3.1. Methodology**

The initial study (AGC Woodward -Clyde, 1991), involved the assessment of the acid forming potential of 18 drill core samples and five samples within the Zn/Pb lode. A second investigation (AARC, 2008) included geochemical analysis of 121 drill core samples and the establishment of a series of kinetic leach column tests. The testing programs for both studies included measurements of:

- Existing pH and conductivity;
- Total sulphur content;
- Acid neutralising capacity (ANC); and
- Net acid producing potential (NAPP).

Multi element assays were also carried out on all samples in the 1991 study and half the samples in the 2008 study.

In the most recent geochemical study, 72 drill cores were sampled. Samples underwent static geochemical testing to evaluate the risk associated with the potential oxidation of sulphides, acid generation, and the presence of metals/metalloids and salts. Static analysis included the following analytes:

- Existing pH and conductivity;
- Total sulphur content;
- Maximum potential acidity (MPA);
- Acid neutralising capacity (ANC);
- Net acid producing potential (NAPP); and
- Net acid generation (NAG) capacity.

More detailed analyses were completed on selected samples to clarify acid rock drainage (ARD) classifications, assess sulphide or carbonate reactivity, and identify elemental enrichments and their potential leachability. A full description of the sampling methodology is presented in Appendix D.

#### **3.5.3.2. ARD Classification**

The ARD classifications of the 18 waste rock samples from the 1991 study were based solely on NAPP values. For all other samples, the ARD classifications were assigned on both NAPP values and net acid generation (NAG) capacity. ARD classifications are defined in Table 29. In summary, PAF waste rock from within the lode will have a high to very high capacity for acid generation. NAF waste rock is expected to be neutral to moderately alkaline.



**Table 29. ARD Classification of DRM Waste Rock (EGi, 2010)**

Lithology	Number of samples	PAF	NAF
Calc-silicate	31	0 (0%)	31 (100%)
Mafic feldspar porphyry	7	0 (0%)	7 (100%)
White mica schist	17	2 (12%)	14 (88%)
Hanging wall slate	52	28 (54%)	24 (46%)
Lode waste	18	13 (72%)	5 (28%)
Footwall slate	44	9 (20%)	35 (80%)
Footwall limestone	42	1 (2%)	41 (98%)

### 3.5.3.3. Elemental Analysis

Elemental analyses of selected samples were carried out to identify any enrichments that might impact the quality of mine water and waste dump seepage. No significant metal or metalloid enrichments were identified in the calc-silicate, mafic feldspar porphyry and white mica schist but many of the hanging wall slate, footwall slate and lode waste samples were highly enriched with one or more of a range of environmentally important elements on comparison to concentrations typically occurring in background soils (EGi, 2010). The most prevalent enrichments were arsenic, cadmium and zinc. There was also less frequent enrichment with copper, lead, mercury, and selenium (EGi, 2010). Leach tests identified that releases of these elements were confined to PAF waste rock. NAF waste rock is not expected to release metals.

### 3.5.3.4. Identification of Waste Rock

Waste rock material is initially classified by the MMG Geologist using both the geological model and the limestone wireframe. Following firing and stockpiling of waste, the MMG Geologist inspects the material and confirms the initial classification as either NAF or PAF. Classified waste rock not required for use as backfill underground is transported to the surface for placement in the appropriate WRD. Once in the dump, the waste rock is again sampled to verify the classification. This ensures that the material has been placed in the correct location.

### 3.5.3.5. Waste Rock Dump Design

The PAF waste rock dump areas are used for the temporary storage of PAF and high sulphur NAF, until the material can be returned underground for stope fill. The PAF waste rock dumps were constructed with a 1m layer of compacted low sulphur NAF waste rock at the base of the dump, to prevent infiltration of contaminants to groundwater.

The waste rock dumps were designed with appropriate surface water drainage controls to ensure that leachate is minimised, and no discharges occur to surface or groundwater resources. Runoff from the PAF waste rock dump is directed to and collected in the Stage 1 PAF Pad Run Off Dam and the Stage

2 PAF Pad Run Off Dam. Dams are regularly inspected, and water levels and quality are monitored as part of DRMs Water Management Strategy. Water captured in the runoff dams is either evaporated or sent to the TSF through the process plant water system.

#### **3.5.3.6. Implications for Closure**

EGi (2010) noted that it was essential that PAF waste rock was not unduly exposed to atmospheric conditions. The PAF waste rock is progressively returned to the underground for use as stope fill. NAF material is suitable to remain on the surface and will be used as a revegetation layer for other domains.

#### **3.5.3.7. Final Landform Design**

As described in Section 3.3, the proposed PMLU's are a mixture of native ecosystem and low intensity grazing. Minor reshaping will be required at certain domains, to ensure the landform is stable and not susceptible to erosion. Waste rock will either be returned to the underground (PAF), disposed of in the TSF (PAF) or used in rehabilitation (NAF). No waste rock dumps are proposed to be retained after mine closure.

The TSF is the only feature that will require significant works to achieve the final landform. All other disturbed areas will be returned to the pre-mining landform. The final landform for the TSF described further below.

#### **3.5.4. TSF Closure Design Objectives**

The PMLU for the TSF is native ecosystem. To achieve the PMLU, rehabilitation of the TSF must achieve the following objectives:

- Control and minimise the transport for oxidation products within the tailings;
- Be capable of supporting vegetation; and
- Be resistant to erosion by wind and or rainfall runoff.

##### **3.5.4.1. Conceptual Tailings Cover System**

ATC (2015) designed the conceptual cover system for the TSF. The cover system is considered to be commensurate with current best practice and regulatory requirements. The following layers will be constructed in the cover system:

- Capillary Break (0.3m, at a density of 1.43 t/m<sup>3</sup>) – mainly coarse, non-acid forming waste rock placed directly over the tailings. The purpose of this layer is to prevent the rise of salts from the underlying tailings to the sealing layer above.
- Sealing Layer (0.5m, at a density of 2.31 t/m<sup>3</sup>) – low permeability compacted earthfill constructed above the capillary break layer to limit water infiltration. This material may need to be sourced from either the non-acid forming weathered waste rock dumps or general earthfill borrow pits located within the project boundaries.

- Waste Rock Cover (1m at a density of 1.64 t/m<sup>3</sup>) – A low water flux cover system will be constructed over the sealing layer consisting of a non-acid forming waste rock layer. Waste rock will be loosely paddock dumped over the sealing layer and then roughly smoothed out with a dozer to encourage infiltration without pooling.
- The final profile of the waste rock cover will be adjusted around the TSF perimeter to minimise erosion due to concentrated storm water flows onto the rehabilitated landform. This will include channels, dissipation bunding and any other passive measures considered necessary at the time of detailed design.
- Topsoil (0.1-0.2m, at a density of 1.7 t/m<sup>3</sup>) – soil stripped from within the impoundment area at the time of construction will be placed on top of the cover system. Good quality topsoil within the TSF impoundment areas is scarce and therefore is unlikely to be sufficient to cover the entire surface. Topsoil will need to be spread thinly and in patches depending on the quantities available.
- The surface of the capped facility will be ripped on the contour, fertilised and seeded with a mix of shallow rooting native species (shrubs and grasses) so as to not compromise the integrity of the sealing layer.

MMG have committed to conducting capping field trials to better understand the actual depths of capping layers and the volume of materials required. Trials will consider the Global Acid Rock Drainage Guide and the INAP Global Cover Systems Design Guide. Capping trials will be completed during the life of operations and the results will be incorporated into future variations of this PRCP.

#### **3.5.4.2. TSF Embankment and Spillway**

To ensure long term stability of the TSF embankment, the crest will be cut down to the final tailings level and the downstream face will be flattened to direct storm water flows off the rehabilitated TSF embankment and out of the Knapdale Valley in a controlled manner. The embankment will be raised, and new spillway channels will be excavated at the northern and southern abutments to allow attenuation and controlled discharge. Additional engineering design activities will be undertaken to ensure the spillway channel accommodates the peak flood flow velocity (predicted to be 6.2 m/s) to achieve a stable spillway condition. Erosion controls, such as erosional velocity dampeners will be designed by a suitably qualified person to ensure long term stability of the embankment and spillway.

Detailed design will evolve as the TSF is filled, with the final tailings surface profile being one of the key inputs to the design (ATC Williams, 2016).

#### **3.5.4.3. TSF Vegetation**

The prepared surface of the TSF will be seeded with a native species mix comparable to Regional Ecosystem 1.11.2 and 1.7.7. Vegetation will reduce erosion whilst removing stored rainfall from the infiltration storage layer of the cap. Shallow rooting species will be used including *Aristida latifolia*, *Eriachne obtusa*, *Sporobolus australasicus*, *Themeda triandra* and *Triodia pungens*. Deep rooting

vegetation such as Eucalyptus Species will not be used to ensure the integrity of the capping system. Features such as large woody debris or boulders will be selectively placed to provide suitable habitat for the Purple Neck Rock Wallaby.

### **3.5.5. Quality Assurance**

Some of the key risks associated with final landform construction are failing to follow design, non-conformance of construction materials to specifications, inadequate quality of construction, failure to correctly implement a QA/QA procedure to identify construction inadequacies. Construction management, technical supervision, and QA/QC of final landforms will be done by an AQP, to ensure that construction aligns with the design plan. QA/QC testing will be completed, post construction, and including tests such as cone penetration testing and permeability testing. An AQP will prepare a QA/QC document to verify landform design is stable and has been constructed in accordance with the design plan.

### **3.5.6. Rehabilitation Trials**

Field trials will commence within five years of approval of the PRCP schedule (2028). This timeline is proposed based on the long life of the operation with anticipated closure being 2048.

The field trials will investigate the performance of the cover system for the TSF. The field trials will be established and maintained for a minimum of five consecutive years. The trials will be carried out in accordance with the following requirements, prescribed in condition PRCP5 of the approved PRCP schedule:

- a) The field trials may be located on another area of the tenure if the mine waste structures have not yet been constructed. The field trials must include multiple alternate cover systems, including the default high risk cover system specified in item #9.01 in Table of Values in the administering authority's ERC Calculator (ESR/2015/1824 Version 5) and the cover system proposed in the Rehabilitation Planning Part.
- b) The following information must be documented prior to commencement of any trials:
  - I. chemical and physical properties of material contained in the landform demonstrating it is representative of the mine waste.
  - II. chemical and physical properties of all cover materials.
  - III. surface and sub-surface preparation requirements including the base/lining layer under the landform (for example, ripping, compacting, establishing bunds).
  - IV. amelioration requirements (for example, gypsum/lime etc, rate, spreading/layer application)
  - V. details of installation methodology.
  - VI. monitoring equipment installation.
  - VII. QA and QC tests and processes implemented for the construction of each layer of the alternate cover system.
- c) Prior to commencement of the trials, a planning report must be submitted to the administering authority that provides details as relevant for the matters above and also provides the following:

- I. specific objectives of the proposed design cover (i.e. reduction in surface water infiltration to a specified rate, prevention of salt rise that would impact on the establishment of vegetation).
  - II. detailed design.
  - III. justification for the quality control and assurance processes that will be implemented for the construction of each layer of the alternate cover system.
  - IV. lab-based material characterisation results.
- d) At a minimum, the following information must be collected during the course of the trial:
- I. Monitoring as per Section 8, INAP Global Cover System guideline (INAP 2017).
  - II. Site specific climate data collected for the duration of the trial.
  - III. Data relating to surface conditions (biological and erosion monitoring).
  - IV. Data from in situ monitoring for:
    - 1) contaminant transport.
    - 2) drainage performance.
    - 3) evapotranspiration.
    - 4) soil performance
    - 5) stability and biological factors..
- e) Following completion of the trial a completion report incorporating supporting data must be provided demonstrating the performance of all trialled cover systems. This report must provide details of the matters described above, in addition to the following:
- I. Demonstration that the proposed cover system will achieve a stable condition (pursuant to section 111A of the EP Act) and comply with criteria specified in this PRCP schedule.
  - II. Updated Landform Evolution Modelling and infiltration modelling based on the results of the trial.
  - III. Calibration processes for all instrumentation.
  - IV. SILO data for the duration of the trial period.
  - V. As constructed plans and report by an appropriately qualified person certifying that each cover system was constructed according to the design in the trial planning report.
  - VI. Destructive/non-destructive testing of each capping layer in the trial plot.
  - VII. In situ QA and QC test report for each capping layer.
  - VIII. QA and QC information for the overall landform construction.
  - IX. Independent\* certification from an appropriately qualified third party specifying the cover system for full scale application, based on the findings from the trial and including any necessary changes.
  - X. Recommendations from an appropriately qualified person regarding the location of primary and secondary monitoring sites and the location of additional lysimeters referred to in RM7.

### **3.5.7.Voids**

There are no proposed voids associated with the Project.



### **3.5.8.Rehabilitation Maintenance**

Monitoring of rehabilitation must take place and demonstrate:

- Landform stability;
- Effective erosion control;
- No negative effects on EV of any waters from stormwater runoff and seepage; and
- Healthy growth and recruitment rates of vegetation, and management of declared plants.

Maintenance activities on rehabilitated areas post-closure will be guided by general site inspections and rehabilitation monitoring. Maintenance may include:

- Management of newly recruited vegetation (addition of fertiliser, re-planting of failed vegetation recruitment) prior to its establishment within the ecosystem;
- Repair eroded areas and damage drainage systems;
- Improved management of surface water runoff through modifying landforms or structures;
- Upkeep of water management structures;
- Removing drainage that is not needed for long-term stability; and
- Replacing and repairing fences and signage (where probable).

It is expected that maintenance will be more intensive in the first years following closure and will gradually decrease as PLMUs begin to establish.

### **3.5.9.Summary of Key Rehabilitation Milestones**

Table 31 summarises the Project rehabilitation milestones. Table 31 further details the key rehabilitation activities for each relevant activity at the Project. The rehabilitation activities drive achievement of the Project rehabilitation milestones and inform the associated PRCP schedule.

Where a milestone criteria requires any of the following, MMG will maintain appropriate records and will provide to DES on request:

- Certifications or assessments to be undertaken;
- Monitoring or maintenance to be carried out;
- Final design plans and/or specifications to be developed; and
- Reports, such as contaminated land investigations, rehabilitation reports (including monitoring records), validation reports and quality assurance/quality control reports.

**Table 30 Key Rehabilitation and Management Practices**

Rehabilitation Milestone	
RM1	Infrastructure decommissioning and removal
RM2	Remediation of contaminated land
RM3	Landform development and reshaping (RA1)
RM4	Landform development and reshaping (RA2)
RM5	Landform development and reshaping (RA3)
RM6	Landform development and reshaping (RA4/RA5)
RM7	Landform development and reshaping (RA6)
RM8	Landform development and reshaping (RA7)
RM9	Surface preparation
RM10	Revegetation (native ecosystem)
RM11	Revegetation (grazing)
RM12	Achievement of surface requirements (native ecosystem)
RM13	Achievement of surface requirements (grazing)
RM14	Achievement of post mining land use to a stable condition (native ecosystem)
RM15	Achievement of post mining land use to a stable condition (grazing)

**Table 31. Key Rehabilitation Activities to Achieve Rehabilitation Milestones**

Rehabilitation Area	Relevant Activities	Rehabilitation Activities	Rehabilitation Timing	Rehabilitation Milestones
RA1	Accommodation village Remaining Ancillary Infrastructure and Services (e.g. warehousing, powerline, raw water pipeline etc)	<ul style="list-style-type: none"> <li>Decommission and remove infrastructure.</li> <li>Remove all surfaces (concrete footings, culverts road base etc.).</li> <li>Conduct a contaminated land assessment.</li> <li>Remove any contaminated material and dispose of at a licenced facility.</li> <li>Complete validation sampling to determine success of contamination removal.</li> <li>Shape landform to be free draining and of similar shape to the surrounding topography.</li> <li>Rip landform parallel to landform contours.</li> <li>Apply ~ 0.2m growth media.</li> <li>Monitor to assess natural revegetation establishment.</li> <li>Apply selected native vegetation seed mix if natural revegetation has not been successful (&lt;30% coverage of analogue site).</li> <li>Monitor to assess rehabilitation success and whether the PMLU has been achieved.</li> </ul>	<ul style="list-style-type: none"> <li>The accommodation village will become available for rehabilitation once mining activities have ceased and the mining workforce is no longer required.</li> <li>Available 2048</li> </ul>	RM1 RM2 RM3 RM9 RM10 RM12 RM14
RA2	Borrow Pit Topsoil Stockpiles	<ul style="list-style-type: none"> <li>Borrow pits have previously been shaped to be stable and free draining post construction. Further shaping may be required if borrow pits are to be recommissioned or additional pits are utilised.</li> <li>Remove topsoil and utilise in rehabilitation activities.</li> <li>Rip landform parallel to landform contours.</li> <li>Apply ~0.2m growth media.</li> <li>Monitor to assess natural revegetation establishment.</li> <li>Apply selected pasture seed mix if natural revegetation has not been successful (&lt;30% coverage of analogue site)</li> <li>Monitor to assess rehabilitation success and whether the PMLU has been achieved.</li> </ul>	<ul style="list-style-type: none"> <li>Area will be available for rehabilitation once borrow pit and topsoil stockpiles have been exhausted.</li> <li>Available 2050</li> </ul>	RM4 RM9 RM11 RM13 RM15
RA3	Dams and diversion structures	<ul style="list-style-type: none"> <li>Decommission any water management infrastructure (pumps, electricity supply etc.) and remove/dispose of.</li> <li>Undertake assessment for contaminated sediment</li> <li>Desilt dams and dispose of sediment appropriately (e.g., contaminated material disposed of at a licenced facility)</li> <li>Remove liners if present.</li> <li>Infill dams with inert material and shape landform to be free draining of similar shape to the surrounding topography.</li> <li>Rip landform parallel to landform contours.</li> <li>Apply ~0.2m growth media.</li> <li>Monitor to assess natural revegetation establishment</li> <li>Apply selected pasture seed mix if natural revegetation has not been successful (&lt;30% coverage of analogue site)</li> <li>Monitor to assess rehabilitation success and whether the PMLU has been achieved.</li> </ul>	<ul style="list-style-type: none"> <li>Runoff dams will be rehabilitated after associated areas (WRDs) have been revegetated.</li> <li>Available 2048</li> <li>Sediment dams will be retained onsite.</li> </ul>	RM1 RM2 RM5 RM9 RM11 RM13 RM15
RA4	Mineralised waste dumps	<p><b>Potentially Acid Forming Material</b></p> <ul style="list-style-type: none"> <li>Disposed of any PAF to underground</li> <li>Excavate approximately 0.5m of material from underneath the PAF waste rock dumps and dispose on in the TSF.</li> <li>Undertake assessment for contaminated sediment</li> <li>Rip landform parallel to landform contours.</li> <li>Apply ~0.2m growth media.</li> <li>Monitor to assess natural revegetation establishment</li> <li>Apply selected pasture seed mix if natural revegetation has not been successful (&lt;30% coverage of analogue site)</li> <li>Monitor to assess rehabilitation success and whether the PMLU has been achieved</li> </ul> <p><b>Non-Acid Forming Material</b></p> <ul style="list-style-type: none"> <li>Removal of NAF from dumps for use in rehabilitation of the TSF.</li> </ul>	<ul style="list-style-type: none"> <li>Any PAF remaining on the surface after closure will be returned underground before the portal is sealed.</li> <li>The NAF waste rock dump will be rehabilitated concurrently with the TSF.</li> <li>Available 2048</li> </ul>	RM2 RM6 RM9 RM11 RM13 RM15

Rehabilitation Area	Relevant Activities	Rehabilitation Activities	Rehabilitation Timing	Rehabilitation Milestones
		<ul style="list-style-type: none"> <li>Undertake assessment for contaminated sediment .</li> <li>Rip landform parallel to landform contours.</li> <li>Apply ~0.2m growth media.</li> <li>Monitor to assess natural revegetation establishment.</li> <li>Apply selected pasture seed mix if natural revegetation has not been successful (&lt;30% coverage of analogue site)</li> <li>Monitor to assess rehabilitation success and whether the PMLU has been achieved</li> </ul>		
RA5	Mining and processing areas	<ul style="list-style-type: none"> <li>Remove surface infrastructure.</li> <li>Undertake assessment for contaminated land and remediate if required.</li> <li>Remove contaminated material and dispose in the TSF (if required).</li> <li>Seal the portals and declines with a 5m long bulkhead.</li> <li>Backfill the box cut void and portal with NAF waste rock.</li> <li>Excavate approximately 0.5m of material from underneath the processing areas, and dispose of in the TSF</li> <li>Rip landform parallel to landform contours.</li> <li>Apply ~0.2m growth media.</li> <li>Monitor to assess natural revegetation establishment.</li> <li>Apply selected pasture seed mix if natural revegetation has not been successful (&lt;30% coverage of analogue site)</li> <li>Monitor to assess rehabilitation success and whether the PMLU has been achieved</li> </ul>	<ul style="list-style-type: none"> <li>Ore may be processed after the cessation of mining activities. Processing areas will become available after all ore has been processed.</li> <li>Available 2048</li> </ul>	RM2 RM6 RM9 RM11 RM133 RM15
RA6	Tailings Storage Facility and Seepage Detection Pond	<p><b>Seepage Detection Pond</b></p> <ul style="list-style-type: none"> <li>Water in seepage detection basin to be pumped back to the TSF (If any).</li> <li>Complete ongoing monitoring of seepage rates and quality until seepage has ceased.</li> <li>Decommissioned and remove infrastructure</li> <li>Undertake assessment for contaminated land and remediate if required.</li> <li>Remove contaminated material and dispose in the TSF (if required).</li> <li>Undertake assessment to determine if contaminated land had been successfully removed</li> <li>Backfill the seepage detection pond with NAF waste rock.</li> <li>Rip landform parallel to landform contours.</li> <li>Apply ~0.2m growth media.</li> <li>Monitor to assess natural revegetation establishment</li> <li>Apply selected pasture seed mix if natural revegetation has not been successful (&lt;30% coverage of analogue site)</li> <li>Monitor to assess rehabilitation success and whether the PMLU has been achieved</li> </ul> <p><b>Tailings Storage Facility</b></p> <ul style="list-style-type: none"> <li>The tailings pipeline will be flushed, decommissioned and disposed of in a licenced facility.</li> <li>Other TSF infrastructure (electrical equipment, water pump back pipelines etc.) to be decommissioned and removed.</li> <li>Complete construction of cover system and spillway/erosion control features.</li> <li>Survey surface of TSF and reshape to achieve a grade of 1% with slope lengths of ~2000m at the southern end of the TSF, and 1150m at the northern end.</li> <li>Construct broad spillway rock chute with slopes of 145 with a slope length of ~230m</li> <li>Conduct QA/QC testing at a rate of 1 sample per hectare to confirm depth of layers and permeability is as specified in the designs and no PAF material is present within the cover system.</li> <li>Monitor to assess natural revegetation establishment</li> <li>Apply selected pasture seed mix if natural revegetation has not been successful (&lt;30% coverage of analogue site)</li> <li>Install monitoring locations determined from rehabilitation trials, including:               <ul style="list-style-type: none"> <li>Meteorological station</li> </ul> </li> </ul>	<ul style="list-style-type: none"> <li>The TSF may remain active post mining cessation as processing of mined ore may continue until ore is depleted. TSF will be available for rehabilitation at the completion of processing.</li> <li>Available 2048</li> </ul>	RM1 RM7 RM9 RM10 RM12 RM14

Rehabilitation Area	Relevant Activities	Rehabilitation Activities	Rehabilitation Timing	Rehabilitation Milestones
		<ul style="list-style-type: none"> <li>○ Piezometers within the tailings and capillary break layer</li> <li>○ Automated in situ water content and suction sensors in each layer of the cover system</li> <li>○ Temperature sensors</li> <li>○ A lysimeter.</li> </ul> <ul style="list-style-type: none"> <li>• Monitor to assess rehabilitation success and whether the PMLU has been achieved</li> </ul>		
RA7	Renewable Energy Infrastructure	<ul style="list-style-type: none"> <li>• Decommission and remove infrastructure.</li> <li>• Remove all surfaces (concrete footings, culverts road base etc.).</li> <li>• Minor rounded at pad crests, where required.</li> <li>• Localised stockpiled material from road and drainage development is replaced.</li> <li>• Monitor to assess natural revegetation establishment.</li> <li>• Apply selected native vegetation seed mix if natural revegetation has not been successful (&lt;30% coverage of analogue site).</li> <li>• Monitor to assess rehabilitation success and whether the PMLU has been achieved.</li> </ul>	<ul style="list-style-type: none"> <li>• The renewable energy infrastructure will continue to be utilised to power the operation until all other infrastructure has been removed.</li> <li>• Available 2050</li> </ul>	RM1 RM2 RM6 RM8 RM9 RM10 RM12 RM14



## 3.6. Risk Assessment

A closure and rehabilitation risk assessment has been prepared in accordance with Section 126C(1)(f) of the EP Act. The risk methodology utilised has been developed based on the *Australia and New Zealand Standard AS/NZS for Risk Management – Principles and Guidelines* (ISO 31000:2018).

The risk management process involves the systematic application of policies, procedures, and practices to the activities of communicating and consulting, establishing the context and assessing, treating, monitoring, reviewing, recording, and reporting risk.

Closure and rehabilitation risk assessments have the objective to identify and define specific risks from closure and rehabilitation and associated activities toward environmental, economic, and social values.

### 3.6.1. Risk Identification

The purpose of risk identification is to find, recognise and describe risks that might help or prevent an organisation achieving its objectives. Relevant, appropriate, and up-to-date information is important in identifying risks (Standards Australia, 2018).

The following factors have been considered by this risk assessment:

- Tangible and intangible sources of risk;
- Causes and events;
- Threats and opportunities;
- Vulnerabilities and capabilities;
- Changes in the external and internal context;
- Indicators or emerging risks;
- The nature and value of assets and resources;
- Consequences and their impacts on objectives;
- Limitations of knowledge and reliability of information;
- Time-related factors; and
- Biases, assumptions, and beliefs of those involved.

### 3.6.2. Risk Analysis and Evaluation

The purpose of risk analysis is to comprehend the nature of risk and its characteristics, including, where appropriate, the level of risk. Risk analysis can be undertaken with varying degrees of detail and complexity, depending on the purpose of the analysis, the availability and reliability of information and the resources available. Risk analysis techniques can be qualitative, quantitative or a combination of these and should include:

- the likelihood of events and consequences;

- the nature and magnitude of consequences;
- complexity and connectivity;
- time-related factors and volatility;
- the effectiveness of existing controls; and
- sensitivity and confidence levels.

A likelihood of occurrence and severity of consequence rating has been assigned to each identified risk in accordance with the risk matrix detailed in Table 32. Control measures have been developed following the identification of risks to achieve a level of risk that is considered to be an acceptable level, as described in Table 33.

**Table 32. Risk Matrix**

Likelihood of Occurrence	Severity of Consequence				
	Catastrophic (5)	Major (4)	Moderate (3)	Minor (2)	Insignificant (1)
Almost certain (5)	10	9	8	7	6
Likely (4)	9	8	7	6	5
Possible (3)	8	7	6	5	4
Unlikely (2)	7	6	5	4	3
Rare (1)	6	5	4	3	2
Risk Score	Risk Rating		Actions Required		
9 – 10	Extreme		Requires immediate action to reduce risk score.		
7 – 8	High		Requires an action plan approved by senior management.		
5 – 6	Moderate		Specific monitoring and procedures required.		
2 - 4	Low		Management through routine procedures and protocols.		

**Table 33. Risk Evaluation**

Rehabilitation Milestone	Hazard	Potential Impact	Risk Rating			Risk Controls	Justification of controls	Residual Risk Rating			Remedial Measures
			L	C	R			L	C	R	
RM1 Infrastructure decommissioning and removal	Infrastructure is not adequately identified during planning process	Failure to remove all infrastructure in accordance with schedule. Achievement of RM1 is delayed.	2	3	5	A register of infrastructure is to be developed to track which structures exist in each rehabilitation area. Demolition works to be scoped with area managers to identify all infrastructure.	The proposed actions will ensure the demolition works are correctly scoped and scheduled.	1	3	4	Contractors will return to site to remove all infrastructure.
RM2 Removal of contaminated land	Previously unidentified contamination source discovered.	Financial cost of remediation. Achievement of RM2 is delayed.	3	3	6	Records are to be kept of all spills and other incidents occurring at the Project that might result in contamination. Employees and contractors are to be made aware of their reporting obligations through a Site Induction. Initial consultation with an approved	Disturbance is restricted to approved areas as defined on the EA. Initial contaminated land assessments will identify areas for further investigation and remediation.	2	3	5	Ongoing rehabilitation monitoring will identify presence of previously unidentified contaminants. Any contamination will be investigated and further contaminated land

Rehabilitation Milestone	Hazard	Potential Impact	Risk Rating			Risk Controls	Justification of controls	Residual Risk Rating			Remedial Measures
			L	C	R			L	C	R	
						contaminated land assessor to identify contamination targets for remediation or removal.					sampling/ removal will be conducted as required.
	Contaminated sediment is not removed to appropriate depth.	Contamination of land and water resources Ongoing cost of remediation Financial cost of remobilising earthworks crew	3	3	6	Conduct validation sampling to determine that contaminant removal has been successful.	To be suitable for a PMLU of low-intensity grazing, contaminated land must be removed from the Contaminated Land Register or the Environmental Management Register. These works must be approved by a suitably qualified person and an approved auditor (under the	2	3	5	Ongoing rehabilitation monitoring will identify presence of previously unidentified contaminants. Any contamination will be investigated and further contaminated land sampling/ removal will be conducted as required

Rehabilitation Milestone	Hazard	Potential Impact	Risk Rating			Risk Controls	Justification of controls	Residual Risk Rating			Remedial Measures
			L	C	R			L	C	R	
							Environmental Protection Act 1999 Act).				
RM3 Landform development and reshaping (RA1)	Final landform not adequately shaped per design.	Reduced safety or instability of landform. Erosion leading to contamination of water ways. Unsuccessfully revegetated.	4	3	7	Landform is assessed as geotechnically stable by a suitably qualified geotechnical engineer	Proposed landform is to be gently sloping, limiting potential for erosion. Little earthworks will be required to achieve profile.	2	3	5	Landform will be reshaped until stability is achieved.
RM4 Landform development and reshaping (RA2)	Final landform not adequately shaped per design.	Reduced safety or instability of landform. Erosion leading to contamination of water ways. Unsuccessfully revegetated.	4	3	7	Landform is assessed as geotechnically stable by a suitably qualified geotechnical engineer	Proposed landform is to be gently sloping, limiting potential for erosion. Little earthworks will be required to achieve profile.	2	3	5	Landform will be reshaped until stability is achieved.
RM5 Landform development and reshaping (RA3)	Final landform not adequately shaped per design.	Reduced safety or instability of landform. Erosion leading to contamination of water ways.	4	3	7	Landform is assessed as geotechnically stable by a suitably qualified	Proposed landform is to be gently sloping, limiting potential for erosion. Little	2	3	5	Landform will be reshaped until stability is achieved.



Rehabilitation Milestone	Hazard	Potential Impact	Risk Rating			Risk Controls	Justification of controls	Residual Risk Rating			Remedial Measures
			L	C	R			L	C	R	
		Unsuccessfully revegetated.				geotechnical engineer	earthworks will be required to achieve profile.				
RM6 Landform development and reshaping (RA4/RA5)	Final landform not adequately shaped per design.	Reduced safety or instability of landform. Erosion leading to contamination of water ways. Unsuccessfully revegetated.	4	3	7	Landform is assessed as geotechnically stable by a suitably qualified geotechnical engineer	Proposed landform is to be gently sloping, limiting potential for erosion. Little earthworks will be required to achieve profile.	2	3	5	Landform will be reshaped until stability is achieved.
	Changes to mine plan resulting in additional PAF waste rock.	Unaccounted for material to be disposed of. Financial cost of waste disposal.	3	3	6	Ongoing mine planning throughout LOM. Materials balance regularly updated. Significant freeboard maintained to allow for TSF disposal.	Early detection of inconsistencies between mine plan and rehabilitation plan will allow adequate opportunity to adjust rehabilitation plan.	2	3	5	PAF will be disposed of in the TSF if additional volume cannot be placed underground.

Rehabilitation Milestone	Hazard	Potential Impact	Risk Rating			Risk Controls	Justification of controls	Residual Risk Rating			Remedial Measures
			L	C	R			L	C	R	
	Incorrect waste type utilised in rehabilitation works (PAF v NAF)	Contamination of land and water resources	3	4	7	Material is tested multiple times before being added to the appropriate WRD. Material will be tested prior to use in rehabilitation activities. PAF will be removed completely prior to disturbance to the NAF WRD.	MMG employ a rigorous testing process to minimise risk of incorrect storage within WRD. Process will continue during rehabilitation works. Removing PAF first will reduce likelihood that incorrect material is selected and transported.	2	4	6	Ongoing rehabilitation monitoring will identify presence of previously unidentified contaminants. Any contamination will be investigated and further contaminated land sampling/ removal will be conducted as required.
RM7 Landform development and reshaping (RA6)	Landform instability	Stability of landform not being achieved, meaning the PMLU cannot be achieved.	3	4	7	The construction and maintenance design of the cover system / cap will be certified by an appropriately qualified person.	Performance measured through inspection by suitably qualified person	2	4	6	Landform will be reshaped until stability is achieved.

Rehabilitation Milestone	Hazard	Potential Impact	Risk Rating			Risk Controls	Justification of controls	Residual Risk Rating			Remedial Measures
			L	C	R			L	C	R	
		Greater erosion risk and release of contaminants Wildlife exposure to contaminants Reduced ability to sustain vegetation Impacts to rehabilitation timing and achievement of rehabilitation milestones. Cover compromised by vegetation				AQP will certify that landform has achieved an acceptable factor of safety QAQC testing will be completed post construction Biannual vegetation monitoring will be completed.					
RM8 Landform development and reshaping (RA7)	Landform instability	Reduced safety or instability of landform. Erosion leading to contamination of water ways. Unsuccessfully revegetated.	4	3	7	Landform is assessed as geotechnically stable by a suitably qualified geotechnical engineer	Proposed landform is to be gently sloping, limiting potential for erosion. Little earthworks will be required to achieve profile.	2	3	5	Landform will be reshaped until stability is achieved.
RM9 Surface preparation	Insufficient topsoil	Erosion Unsuccessfully revegetated.	4	3	7	Topsoil will be selectively placed at in 5m wide sections.	The area naturally has low volumes of	3	3	6	Ongoing erosion and vegetation

Rehabilitation Milestone	Hazard	Potential Impact	Risk Rating			Risk Controls	Justification of controls	Residual Risk Rating			Remedial Measures
			L	C	R			L	C	R	
		Cost of repeating landform reshaping and surface preparation.				Additional topsoil will be obtained from an external source if required.	topsoil. Vegetation has proven to establish successfully on rocky areas with limited topsoil.				monitoring will guide management interventions. Additional topsoil or ameliorants will be applied as required.
	Inappropriate topsoil management whilst stockpiled	Reduced viability of topsoil, limiting plant establishment at rehabilitated sites. Topsoil infested with weed propagules, which will invade rehabilitated sites.	3	2	5	Topsoil is managed as per existing site procedures. Topsoil is recorded in the Topsoil Register and is inspected regularly.	Site has established processes to minimise risk.	2	2	4	Topsoil will be inspected prior to application. Any contaminated topsoil will not be used for rehabilitation.
	Vehicles contaminated with weed seeds used for earthworks.	Weeds invading rehabilitated sites, inhibiting the establishment of desirable species and preventing	3	2	5	Vehicles will be inspected prior to entering site. Vehicles will be cleaned in the site washdown bay if	Site has established processes to minimise risk.	2	2	4	A weed treatment program will be implemented, if required.

Rehabilitation Milestone	Hazard	Potential Impact	Risk Rating			Risk Controls	Justification of controls	Residual Risk Rating			Remedial Measures
			L	C	R			L	C	R	
		achievement of RM11 and RM12.				weeds or seeds are identified.					
	Heavy rainfall occurring prior to establishment of vegetative cover.	Loss of topsoil Siltation of downstream waterways. Failure of vegetation to establish on eroded surfaces. Cost of reapplying topsoil to eroded surfaces	3	2	5	Earthworks will be completed during the dry season. Earthworks will be scheduled progressively so that areas are exposed for the least amount of time possible.	The area has established wet/dry seasons and works can be scheduled.	2	2	4	Rehabilitation monitoring will guide corrective action (reseeding, etc) as required.
RM10 Revegetation (native ecosystem)	Natural revegetation unsuccessful	Inability to meet RM11 and RM13	3	2	5	Areas will be monitored annually, for 5 years, and seeded if natural vegetation is unsuccessful	Annual monitoring will allow early detection if seeded is required.	2	2	4	Apply seed as required.
	Heavy rain immediately after seeding.	Loss of topsoil. Siltation of downstream waterways. Failure of vegetation to establish on eroded surfaces.	3	2	5	Low slope gradient in landform design to limit capacity for sediment loss. Surface preparation and sowing is not to take place if heavy rain (>40 mm) is	The area has established wet/dry seasons and works can be scheduled taking this into account.	2	2	4	Rehabilitation monitoring will guide corrective action (reseeding, etc) as required.



Rehabilitation Milestone	Hazard	Potential Impact	Risk Rating			Risk Controls	Justification of controls	Residual Risk Rating			Remedial Measures
			L	C	R			L	C	R	
		Cost of reapplying topsoil and seed to eroded surfaces.				forecast over any one day within the next fortnight.					
	Drought over the first months after planting.	Poor seedling survival and establishment. Increased exposure of bare soil leading to erosion	3	2	5	Planting is to take place in the early wet season, when probability of further rain during seedling establishment is high.	The area has established wet/dry seasons and works can be scheduled taking this into account.	2	2	4	Rehabilitation monitoring will guide corrective action (reseeding, etc) as required.
	Vehicles and/or footwear contaminated with weed seeds	Weeds invading rehabilitated sites, inhibiting the establishment of desirable species and preventing achievement of RM11 and RM13.	3	2	5	Vehicles will be inspected prior to entering site. Vehicles will be cleaned in the site washdown bay if weeds or seeds are identified.	The site has established controls.	2	2	4	A weed treatment program will be implemented, if required.
	Intruding livestock.	Grazing could lead to poor seedling establishment.	2	2	4	RA1 and RA6 largely inaccessible to cattle due to steep slope. Areas will be fenced.	Fencing will limit cattle access.	1	2	3	Rehabilitation monitoring will guide corrective action (reseeding,

Rehabilitation Milestone	Hazard	Potential Impact	Risk Rating			Risk Controls	Justification of controls	Residual Risk Rating			Remedial Measures
			L	C	R			L	C	R	
										etc) as required.	
RM11 Revegetation (grazing)	Natural revegetation unsuccessful	Inability to meet RM12 and RM14	3	2	5	Areas will be monitored annually, for 5 years, and seeded if natural vegetation is unsuccessful	Annual monitoring will allow early detection if seeded is required.	2	2	4	Rehabilitation monitoring will guide corrective action (reseeding, etc) as required.
	Heavy rain immediately after seeding.	Loss of topsoil. Siltation of downstream waterways. Failure of vegetation to establish on eroded surfaces. Cost of reapplying topsoil and seed to eroded surfaces.	3	2	5	Low slope gradient in landform design to limit capacity for sediment loss. Surface preparation and sowing is not to take place if heavy rain (>40 mm) is forecast over any one day within the next fortnight.	The area has established wet/dry seasons and works can be scheduled taking this into account.	2	2	4	Rehabilitation monitoring will guide corrective action (reseeding, etc) as required.
	Drought over the first months after planting.	Poor seedling survival and establishment.	3	2	5	Planting is to take place in the early wet season, when probability of further	The area has established wet/dry seasons and works can	2	2	4	Rehabilitation monitoring will guide corrective

Rehabilitation Milestone	Hazard	Potential Impact	Risk Rating			Risk Controls	Justification of controls	Residual Risk Rating			Remedial Measures
			L	C	R			L	C	R	
		Increased exposure of bare soil leading to erosion				rain during seedling establishment is high.	be scheduled taking this into account.				action (reseeding, etc) as required.
	Vehicles and/or footwear contaminated with weed seeds	Weeds invading rehabilitated sites, inhibiting the establishment of desirable species and preventing achievement of RM12 and RM14.	3	2	5	Vehicles will be inspected prior to entering site. Vehicles will be cleaned in the site washdown bay if weeds or seeds are identified.	The site has established controls.	2	2	4	A weed treatment program will be implemented, if required.
	Intruding livestock.	Grazing could lead to poor seedling establishment.	3	2	5	Areas will be fenced until RM12 is achieved.	Fencing will limit cattle access.	2	2	4	Rehabilitation monitoring will guide corrective action (reseeding, etc) as required.
RM12 Achievement of surface requirements (native ecosystem)	Weed species dominating native species	Weeds spreading to other rehabilitation areas. Outcompeting native species	3	2	5	Annual monitoring to identify high risk areas.	The site has established controls.	2	2	4	A weed treatment program will be

Rehabilitation Milestone	Hazard	Potential Impact	Risk Rating			Risk Controls	Justification of controls	Residual Risk Rating			Remedial Measures
			L	C	R			L	C	R	
		Cost of treatment Delay in achieving RM				Weed treatment completed early to minimise outbreak					implemented, if required.
	Revegetation unsuccessful	Erosion Potential weed recruitment Delay in achieving RM Cost of additional seeding	3	3	6	Annual monitoring to high risk areas. Seeding to occur if revegetation is not successful	Annual monitoring will allow early detection if seeded is required.	2	3	5	Rehabilitation monitoring will guide corrective action (reseeding, etc) as required.
	Persistent seepage from TSF	Contamination of land and water resources Risk to native wildlife accessing as drinking water Cost of contaminated liquid disposal. Delay in achieving RM	4	4	8	Seepage collection pond to remain operational until seepage is not detected.	The seepage collection pond is a critical control for this risk.	3	4	7	Pond will remain operational. Ongoing monitoring of the cover system, vegetation and water quality will guide correction action as required.

Rehabilitation Milestone	Hazard	Potential Impact	Risk Rating			Risk Controls	Justification of controls	Residual Risk Rating			Remedial Measures
			L	C	R			L	C	R	
	Significant erosion	Loss of topsoil. Siltation of downstream waterways. Failure of vegetation to establish on eroded surfaces. Cost of reapplying topsoil and seed to eroded surfaces.	3	2	5	Low slope gradient in landform design to limit capacity for sediment loss. Annual monitoring to identify high risk areas	Monitoring will allow early identification and intervention.	2	2	4	Rehabilitation monitoring will guide corrective action (topsoiling etc) as required.
RM13 Achievement of surface requirements (grazing)	Weed species dominating native species	Weeds spreading to other rehabilitation areas. Outcompeting native species Cost of treatment Delay in achieving RM	3	2	5	Annual monitoring to identify high risk areas. Weed treatment completed early to minimise outbreak	Monitoring will allow early identification and intervention	2	2	4	A weed treatment program will be implemented, if required.
	Revegetation unsuccessful	Erosion Potential weed recruitment Delay in achieving RM Cost of additional seeding	3	3	6	Annual monitoring to high risk areas. Seeding to occur if revegetation is not successful	Annual monitoring will allow early detection if seeding is required.	2	3	5	Rehabilitation monitoring will guide corrective action (reseeding, etc) as required.



Rehabilitation Milestone	Hazard	Potential Impact	Risk Rating			Risk Controls	Justification of controls	Residual Risk Rating			Remedial Measures
			L	C	R			L	C	R	
	Significant erosion	Loss of topsoil. Siltation of downstream waterways. Failure of vegetation to establish on eroded surfaces. Cost of reapplying topsoil and seed to eroded surfaces.	3	2	5	Low slope gradient in landform design to limit capacity for sediment loss. Annual monitoring to identify high risk areas	Monitoring will allow early identification and intervention.	2	2	4	Rehabilitation monitoring will guide corrective action (topsoiling etc) as required.
	Intruding livestock.	Grazing could lead to poor seedling establishment.	3	2	5	Areas will be fenced until RM12 is achieved.	Fencing will limit cattle access.	2	2	4	Rehabilitation monitoring will guide corrective action (reseeding, etc) as required.
RM14 Achievement of post mining land use to a stable condition (native ecosystem)	Weed species dominating native species	Weeds spreading to other rehabilitation areas. Outcompeting native species Cost of treatment Delay in achieving RM	3	2	5	Annual monitoring to identify high risk areas. Weed treatment completed early to minimise outbreak	Monitoring will allow early identification and intervention	2	2	4	A weed treatment program will be implemented, if required.

Rehabilitation Milestone	Hazard	Potential Impact	Risk Rating			Risk Controls	Justification of controls	Residual Risk Rating			Remedial Measures
			L	C	R			L	C	R	
	Revegetation unsuccessful	Erosion Potential weed recruitment Delay in achieving RM Cost of additional seeding	3	3	6	Annual monitoring to high risk areas. Seeding to occur if revegetation is not successful	Annual monitoring will allow early detection if seeding is required.	2	3	5	Rehabilitation monitoring will guide corrective action (reseeding, etc) as required.
	Persistent seepage from TSF	Contamination of land and water resources Risk to native wildlife accessing as drinking water Cost of contaminated liquid disposal. Delay in achieving RM	4	4	8	Seepage collection pond to remain operational until seepage is not detected.	The seepage collection pond is a critical control for this risk.	3	4	7	Pond will remain operational. Ongoing monitoring of the cover system, vegetation and water quality will guide correction action as required.
	Significant erosion	Loss of topsoil. Siltation of downstream waterways.	3	2	5	Low slope gradient in landform design to	Monitoring will allow early	2	2	4	Rehabilitation monitoring will guide

Rehabilitation Milestone	Hazard	Potential Impact	Risk Rating			Risk Controls	Justification of controls	Residual Risk Rating			Remedial Measures
			L	C	R			L	C	R	
		Failure of vegetation to establish on eroded surfaces. Cost of reapplying topsoil and seed to eroded surfaces.				limit capacity for sediment loss. Annual monitoring to identify high risk areas	identification and intervention.				corrective action (topsoiling etc) as required.
RM15 Achievement of post mining land use to a stable condition (grazing)	Weed species dominating native species	Weeds spreading to other rehabilitation areas. Outcompeting native species Cost of treatment Delay in achieving RM	3	2	5	Annual monitoring to identify high risk areas. Weed treatment completed early to minimise outbreak	Monitoring will allow early identification and intervention	2	2	4	A weed treatment program will be implemented, if required.
	Revegetation unsuccessful	Erosion Potential weed recruitment Delay in achieving RM Cost of additional seeding	3	3	6	Annual monitoring to high risk areas. Seeding to occur if revegetation is not successful	Annual monitoring will allow early detection if seeding is required.	2	3	5	Rehabilitation monitoring will guide corrective action (reseeding, etc) as required.
	Significant erosion	Loss of topsoil. Siltation of downstream waterways.	3	2	5	Low slope gradient in landform design to limit capacity for sediment loss.	Monitoring will allow early identification and intervention.	2	2	4	Rehabilitation monitoring will guide corrective

Rehabilitation Milestone	Hazard	Potential Impact	Risk Rating			Risk Controls	Justification of controls	Residual Risk Rating			Remedial Measures
			L	C	R			L	C	R	
		Failure of vegetation to establish on eroded surfaces. Cost of reapplying topsoil and seed to eroded surfaces.				Annual monitoring to identify high risk areas					action (topsoiling etc) as required.
	Landform doesn't support grazing	Delay in achieving PMLU.	3	4	7	Annual monitoring to determine trajectory of vegetation establishment. Re-seeding as required.	PMLU is consistent with surrounding land use. Monitoring will allow early identification and intervention.	2	4	6	Rehabilitation monitoring will guide corrective action (seeding, etc) as required

## 3.7. Monitoring and Maintenance

### 3.7.1. Rehabilitation Monitoring Phases

The Rehabilitation Monitoring Program (Section 3.7.1) has been designed to demonstrate that RM14 and RM15 have been achieved. There are three main phases to the Project's rehabilitation monitoring program as displayed in Figure 15.

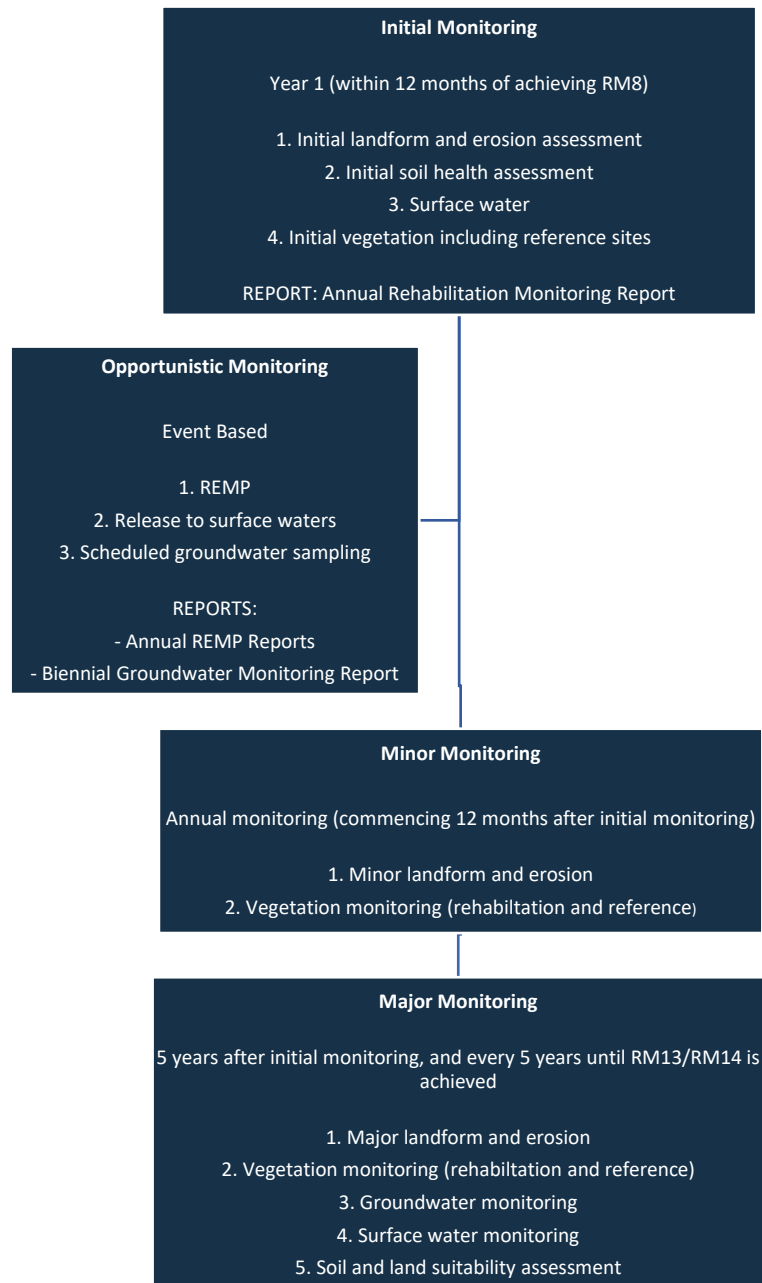


Figure 15. Rehabilitation Monitoring Phases

### **3.7.2. Establishment of Reference Sites**

Analogue sites will be used to compare rehabilitation success with regard to groundcover, carrying capacity, weed proportion and species mix. Analogue sites will be established for each SMU to be rehabilitated. Analogue sites will be recorded using GIS and signposted to prevent disturbance during operational activities.

Monitoring of analogue sites will be completed using the same monitoring methods employed at rehabilitation areas, as described below. Monitoring will be completed biannually, in the wet and dry seasons, for the first five years of sites being established. Following this, this monitoring program will be spaced at 5-yearly intervals.

Early monitoring of reference sites will allow site specific milestone criteria to be developed for future rehabilitation works.

### **3.7.3. Monitoring Program**

A Monitoring and Maintenance Program has been developed for the Project in accordance with Section 3.8 of the PRC Plan Guideline. The objective of the monitoring program is to evaluate the progress of rehabilitation towards fulfilling the rehabilitation criteria as well as to implement adaptive management techniques and interventions as required. The program will:

- Compare monitoring results against rehabilitation milestone criteria;
- Determine the trajectory of rehabilitation success;
- Identify areas for improvement;
- Compare rehabilitation areas to analogue sites;
- Assess effectiveness of environmental controls;
- Assess vegetation health;
- Identify areas where seeding or the application of fertilizers/ameliorants may be required;
- Assess existing and potential erosion; and
- Assess native fauna species diversity and the effectiveness of habitat creation for target fauna species.

Landscape function analysis will be used to assess the biophysical functioning of the rehabilitated ecosystems, in terms of soil habitat. These assessments will determine how resilient rehabilitated areas are when posed with possible disturbance, high rainfall events, and various climatic conditions. The process provides a snapshot of rehabilitation performance, and how sustainable vegetation will be long-term.

The success of rehabilitated areas will be determined by continued progression, stability, and self-sustainability, with analogue sites providing a comparative basis. Rehabilitated areas are expected to reach the same landscape functionality as a given analogue site.



### **3.7.3.1. Initial Monitoring Program**

Initial monitoring will occur approximately 12 months after rehabilitation has commenced to observe the success, identify risks, and develop baseline data.

The elements of rehabilitation that will be assessed during this program are:

- Landform and erosion;
- Soils;
- Vegetation;
- Fauna;
- Surface water;
- TSF seepage; and
- Groundwater.

#### **3.7.3.1.1. Desktop Monitoring**

The initial monitoring program will involve desktop monitoring prior to on-site monitoring work. Using LiDAR and aerial imagery, an understanding of the following can be gained:

- Assessing landform design through a Digital Elevation Model;
- Potential erosion areas to investigate during field surveys;
- Representative locations to establish permanent monitoring plots in respect to the rehabilitation slope, PMLUs, and accessibility.

#### **3.7.3.1.2. Landform and Erosion**

As discussed in Section 3.1.28, all soil types identified within the Project, express a low to medium erosion risk. Therefore, on ground monitoring will focus on any high risk areas identified during the desktop monitoring. Due to the potential risk of exposed contaminants, a focus area for erosion monitoring will be the capped surface of the TSF. In addition, the TSF will be monitored for surface ponding and infiltration to determine the effectiveness of the cover system. Monitoring locations will be determined based on the final surface of the TSF on closure.

#### **3.7.3.1.3. Soil**

A soil monitoring program will be developed for the topsoil stockpiles, prior to use, and will aim to:

- Optimise rehabilitation processes;
- Accurately measure utilisation of stockpile storage and soil reuse; and
- Identify the need and rate of soil amelioration.

Additional insitu sampling may be conducted during initial and major monitoring at areas identified as having low vegetation recruitment.

Samples will be acquired and analysed at an accredited laboratory. The analytes proposed to be tested are detailed in Table 35.

**Table 34. Analysis Parameters for the Soil Monitoring Program**

Parameter	Purpose	Monitoring phase			
		Topsoil	Subsoil	Initial	Major
pH	Identify variations that may inhibit plant growth and sustainability.	x	x	x	x
EC and Chloride	Identify areas that may inhibit germination and establishment.	x	x	x	x
Exchangeable cations	Links to soil stability, fertility, nutrient availability, and structure.	x	x	x	x
Organic carbon	Indicates soil nutrient stores and soil structure. Variations can indicate successfulness.	x		x	x
Major elements including N, P, K, S, Ca, and Mg.	Indicator of nutrients and potential for runoff or acid Metalliferous drainage.	x		x	x
Trace elements including Mn, Fe, Zn, and Cu	All are important to the vegetation success.	x		x	x
Metals	Metals that have been identified as occurring at elevated levels during material characterisation should be tested for during monitoring.	x	x	x	x
Physical parameters	Soil texture and other characteristics will effect water entry and storage as well as impact on erosion, dispersion, and success.	x	x	x	
Field analysis	Gain an understanding of soil profile characteristics for interpretation purposes.	x	x	x	

#### **3.7.3.1.4. Vegetation**

Initial vegetation monitoring will focus on germination success rate of target species, through natural revegetation. Vegetation monitoring will be conducted using the following methods:

- Queensland Herbarium Survey Technique (species richness and tree/shrub densities);
- Ground cover percentage method; and
- Photographic monitoring.

#### **3.7.3.1.5. Fauna**

MMG currently operates a purple necked rock wallaby monitoring program, with sampling twice per year. This program will continue throughout the rehabilitation period until RM13 is achieved. Presence of the PNRW at RA1 and RA6 will provide evidence of successful rehabilitation.

#### **3.7.3.1.6. Surface Waters**

Event based monitoring will be conducted at surface water monitoring locations as defined in the EA. These monitoring locations will provide data across the whole site, including downstream of the TSF. Surface water quality results will be compared to ANZECC/ARMCANZ (2000) Table 3.3.4 values for slightly to moderately disturbed aquatic ecosystems to determine rehabilitation success. Compliance will be defined as all results complying with the vales for a minimum of five consecutive years.

The REMP monitoring will continue at locations specified in the REMP design document. Reports will be provided to the DES as requested. Downstream locations will be compared to reference sites to assess potential impact from rehabilitated areas.

#### **3.7.3.1.7. TSF Seepage**

Seepage from the TSF will continue to be collected in the seepage collection pond throughout rehabilitation activities. Once the surface of the TSF is capped, seepage will be pumped to a storage tank before being disposed of at a licenced facility. Seepage rates and volumes will be continuously recorded. Regular water quality samples of seepage, surface waters and groundwaters will be obtained during the initial monitoring round. Visual observations will monitor for the presence of seepage at the toe of the embankments and will inform additional monitoring as needed. Additionally, infiltration will be monitored to assess the potential risks of seepage long term.

#### **3.7.3.1.8. Groundwater**

Groundwater will continue to be monitored quarterly at locations defined in the EA. These monitoring locations will provide data across the whole site, including downstream of the TSF. Water quality results will be compared to ANZECC/ARMCANZ Table 4.3.2 for livestock drinking water. Compliance will be defined as all results from MB5, MB6, MB9S and MB9D complying with the vales for a minimum of five consecutive years.

### **3.7.3.2. Minor Monitoring Methods**

Minor monitoring will continue on a biannual basis (wet and dry) for the first five years following rehabilitation. The minor monitoring methods have been designed with two aims; to quickly identify and resolve issues as well as create a replicable record of the condition and success of rehabilitation. The permanent monitoring points from the initial monitoring program will continue along with any new erosion areas identified during monitoring. The aspects of focus are:

- Landform and erosion;
- Vegetation;
- Surface water;

- TSF seepage; and
- Groundwater.

#### **3.7.3.2.1. Desktop Monitoring**

The minor monitoring will involve desktop monitoring prior to on-site monitoring work. Through the use of LiDAR and aerial imagery, the following can be achieved:

- Update the Digital Elevation Model;
- Identify new areas of potential sedimentation and/or ponding; and
- Identify new areas of erosion for observation.

#### **3.7.3.2.2. Landform and Erosion**

Along with the permanent monitoring sites created during the initial program, other points identified during the desktop monitoring may be added. The data to be collected includes the coordinates, estimated topsoil coverage, and erosional process, size, state (active, partly stabilised, or stabilised), and severity.

#### **3.7.3.2.3. Vegetation**

Vegetation monitoring will continue biannually (wet and dry) as per the initial monitoring methods. At the fixed points determined in the initial program, the acceptance criteria will be utilised as required to determine the level of success and ensure the rehabilitation areas are on a trajectory to meet the milestone criteria.

Preliminary completion criteria are presented in Table 35. Completion criteria will be finalised based on results from monitoring at reference sites during the life of the operation.

**Table 35 Preliminary Completion Criteria Summary**

Criterion	Completion Score
T1 Height	70% of reference site
Total Native Tree Species	70% of reference site
Shrub Species Richness	70% of reference site
Grass Species Richness	70% of reference site
Forbes and Other Species Richness	70% of reference site
Non-native Plant Cover (%)	<10%
Native Perennial Grass Cover (%)	70% of reference site
Native Forbes and Other Species Cover (%)	70% of reference site
Native Shrubs Cover (%)	25% of reference site
Non-native Grass Cover (%)	<10%
Non-native Forbes and Other Species Cover (%)	<10%
Stems/hectare (tree)	70% of reference site
Stems/hectare (shrub)	50% of reference site
Stems/hectare (eucalypt)	25% of reference site

**3.7.3.2.4. Surface Water**

Monitoring of surface waters will continue as per the initial monitoring phase.

**3.7.3.2.5. TSF Seepage**

Monitoring of TSF seepage will continue as per the initial monitoring phase.

**3.7.3.2.6. Groundwater**

Monitoring of ground waters will continue as per the initial monitoring phase.

**3.7.3.3. Major Monitoring Methods**

Major monitoring will occur 5 years following rehabilitation, and every 5 years thereafter until a stable condition is achieved. The purpose for the major monitoring is to assess the performance of the rehabilitation. The points to be monitored will continue from the previous phases as well as any additional erosion areas identified during monitoring. The focus of the major monitoring includes:

- Landform and erosion;
- Soil and spoil;
- Vegetation;
- Surface Water;
- TSF Seepage;
- Groundwater; and
- Grazing Land Suitability Assessment.

#### **3.7.3.3.1. Desktop Monitoring**

The major monitoring will involve desktop monitoring prior to on-site monitoring work. Through the use of LiDAR and aerial imagery, the following can be gained:

- An understanding of historic conditions through a review of previous monitoring reports;
- Update the Digital Elevation Model and compare against previous models to detect changes;
- Identify new areas of erosion for field validation.

#### **3.7.3.3.2. Landform and Erosion**

The focus will be towards assessing erosion at previous monitoring locations as well as any other areas identified during desktop monitoring.

#### **3.7.3.3.3. Soil**

The major monitoring will follow the procedures, sampling, and analysis of the initial program. The data can be compared to the baseline data to evaluate the rehabilitation performance as well as identify trends. The data will indicate the level of achievement or if remediation action is required.

#### **3.7.3.3.4. Vegetation**

Monitoring will continue as described in the initial monitoring methods.

#### **3.7.3.3.5. Grazing Land Suitability Assessment**

A land suitability assessment will demonstrate achieving the RM15 milestone criteria for a PMLU of cattle grazing at:

- Year five of the major monitoring to allow vegetation to establish; and
- Each scheduled major monitoring from Year 10+ until the rehabilitation meets the milestone criteria.

#### **3.7.3.3.6. Surface Water**

Monitoring of surface waters is to continue as per the initial monitoring phase. To achieve the PMLU, downstream water quality is required to meet the ANZECC/ARMCANZ (2000) Table 3.3.4 values for slightly to moderately disturbed aquatic ecosystems for five consecutive years.

#### **3.7.3.3.7. TSF Seepage**

Monitoring of TSF seepage will continue as per the initial monitoring phase.

#### **3.7.3.3.8. Groundwater**

Groundwater samples will be collected and analysed to achieve milestone criteria. To achieve the PMLU, groundwater quality is required to meet the ANZECC/ARMCANZ Table 4.3.2 for livestock drinking water for five consecutive years.



#### **3.7.3.4. Opportunistic Monitoring**

The creeks and drainage lines at the Project are ephemeral therefore inhibiting the ability to collect and assess surface water samples within fixed timings. Resultingly, surface water monitoring is required to be undertaken at nominated points when available and accessible. Monitoring will be conducted during releases as per the existing schedule in the EA.

#### **3.7.4. Maintenance**

Monitoring activities may identify rehabilitated areas that required additional maintenance. This could be a result of:

- Climate conditions;
- Invasive species;
- Drainage design;
- Insufficient vegetative cover;
- Surrounding land use influence; and
- Soil health.

Where required, maintenance activities will be planned and conducted to ensure the long term success of rehabilitation.

#### **3.7.5. Analysis, Recording, and Reporting**

All monitoring will occur in accordance with relevant Queensland Guidelines including the Queensland Monitoring and Sampling Manual. This includes appropriately qualified personnel collecting and analysing the samples and data. The data will be analysed to identify trends, changes, anomalies, and to track progress. Throughout the process, the data and achievements will be assessed against the milestone criteria and remedial actions will occur where necessary.

The relevant data will be stored and processed within internal geospatial and document management systems.

#### **3.7.6. Quality Assurance**

All staff undertaking monitoring and reporting activities will be suitably qualified for that task. Quality assurance / quality control (QAQC) methodologies will be followed and acted upon should breaches in QAQC procedures occur.

Samples collected will be sent to a NATA accredited laboratory for analysis. For surface water and groundwater samples, at a minimum, for every 10 sites sampled, one field blank, travel blank, and duplicate sample will be taken.

Results from this monitoring program will provide information for future and post-mine closure monitoring requirements.

The monitoring and maintenance allows for a repetitive execution-verification-monitoring QAQC approach to ensure rehabilitation areas progress and achieve the milestone criteria.

### **3.7.7.Review**

This Plan will be reviewed by an SQP should an amendment to the PRCP be made or under timed renewal of the PRCP. In the context of monitoring, a review of the plan must consider:

- Environmental performance;
- Rehabilitation objectives and indicators;
- Environmental inspection outcomes;
- Changes in relevant legislation, policy and guidelines;
- Changes in the mine plan; and
- Rehabilitation completion criteria.

### **3.7.8.EA Relinquishment**

Prior to certification of progressive rehabilitation for part of the Project, or acceptance of EA surrender for part or the whole of the Project tenure, DES must be satisfied with the rehabilitation. The decision is based on either a final rehabilitation report (section 264 of the EP Act) for the whole Project tenure or a part being surrendered, or a progressive rehabilitation report for part of the Project (section 318Z of the EP Act).

The Proponent is required to prepare either of the above, including a compliance statement, and submit to DES for assessment. Relevant rehabilitation requirements (section 318Z or section 268 of the Ep Act) will be considered by DES when deciding whether to certify progressive rehabilitation or to approve surrender application. A post-relinquishment plan will also need to be developed by the proponent to assist with ongoing land management beyond the surrender of the Project tenure.

## 4. References

- AARC. 2010a. *Dugald River Project Soil and Land Suitability Assessment*. Prepared for MMG Limited, AustralAsian Resource Consultants
- AARC. 2010b. *Dugald River Environmental Impact Assessment*. Prepared for MMG Limited, AustralAsian Resource Consultants
- ATC Williams (2016). *Tailings Storage Facility Design Report*. Prepared for MMG Limited
- ATC Williams (2015). *MMG Dugald River Tailings Storage Facility Revised Concept Design*. Prepared for MMG Limited
- Australian And New Zealand Governments (2018). *Australian and New Zealand Guidelines for Fresh and Marine Water Quality*. Australian and New Zealand Governments and Australian state and territory governments, Canberra ACT, Australia
- BOM (2021), *Climate Statistics for Australian locations – Cloncurry Airport (029141)* [Online]. Bureau of Meteorology. Available: [http://www.bom.gov.au/climate/averages/tables/cw\\_029141.shtml](http://www.bom.gov.au/climate/averages/tables/cw_029141.shtml) [Accessed 28/02/2022].
- CDM Smith (2021). *Dugald River Mine Biennial Review of Groundwater Monitoring Data: 2019-2020*. Prepared for MMG Limited, CDM Smith
- Department of Agriculture Water and the Environment DAWE. 2021. *Protected Matters Search Tool* [Online]. Available: <https://www.environment.gov.au/epbc/protected-matters-search-tool> [Accessed 30/03/22].
- Commonwealth Scientific And Industrial Research Organisation And Bureau Of Meteorology (2020). *State Of The Climate Report*.
- EGi (2011), *Dugald River Project Qld Assessment of the Geochemical Characteristics and ARD Potential of Waste Rock for the Dugald River Zinc, Lead & Silver Deposit*, Prepared for MMG Dugald River Pty Limited, Environmental Geochemistry International Pty Ltd
- Guideline ESR/2019/4964 – *Progressive rehabilitation and closure plans (PRC plans)*, Version 2.00 – 17 March 2021.
- QUEENSLAND GOVERNMENT. 2022. *Queensland Globe* [Online]. Available: <https://qldglobe.information.qld.gov.au/>
- Queensland Government 2014. *Regional Planning Interests Act 2014*. Current as at 3 July 2017
- Queensland Government 1989. *Mineral Resources Act 1989*. Current as at 18 June 2021 ed.
- Queensland Government 1994. *Environmental Protection Act 1994*. Current as at 23 April 2021 ed.
- SGM Environmental (2019), *Column Cover Trials*. Prepared for MMG

Wulguru Technical Services Pty Ltd (2021). Dugald River Mine - Environmental Authority Amendment – Supporting *Information*. Prepared by Wulguru Technical Services Pty Ltd for MMG Dugald River Pty Ltd.

WRM (2010). *Dugald River Project Surface Water Assessment*. WRM Water & Environment Pty Ltd.

## Appendix A: PRCP Schedule

## **Progressive Rehabilitation and Closure Plan Schedule template**

### **Instructions**

#### **General Instructions:**

- This form can be used for completing a PRCP schedule for the submission of a progressive rehabilitation and closure plan (PRC plan).
- See the PRCP schedule section of the PRC plan guideline (ESR/2019/4964) for further information requirements.
- A default value of one (1) Rehabilitation Area (RA) is represented by one RA sheets below (RA1).
- A default value of one (1) Improvement Area (IA) is represented by one IA sheet below (IA1).
- To record additional RAs for your project make a copy of the RA sheet below and update it to the relevant RA number (i.e. RA2).
- To record additional IAs for your project make a copy of the IA sheet below and update it to the relevant IA number (i.e. IA2).
- To remove the IA sheet if there is no IA for your project, delete the IA sheet below.
- Each RA and IA sheet contains **two separate excel tables** (yellow and blue) for recording the time-based rehabilitation milestones.
- Add a new column or row to each table as required for your information requirements.
- Two (2) separate sheets below exist for recording the "Rehabilitation Area Milestones" and "Improvement Area Milestones".
- Delete the Improvement Area Milestone sheet if it does not apply to your project.
- Delete additional rows in either sheet if they do not apply to your project.
- See the PRC plan guideline for a list of reference milestones and further information for developing additional site-specific milestones where appropriate.

#### **Further Instructions when inputting PMLUs**

##### **Headings under Rehabilitation Area (RA) sheets**

**Rehabilitation area** - The rehabilitation area must align with the spatial information included in the rehabilitation planning part of the PRC plan. This area must have the same PMLU and same milestones applied to the whole area.

**Relevant activities** - The relevant activities must align with the activities identified in the rehabilitation planning part of the PRC plan. The relevant activities are those undertaken within the rehabilitation area prior to land becoming available for rehabilitation.

**Total size of rehabilitation area (ha)** - Total size of rehabilitation area in hectares.

**Commencement of first milestone** - The applicant must nominate a date for when the first milestone for the rehabilitation area will commence. The milestone reference for the first milestone must be included in the heading.

**PMLU** - The PMLU must align with those identified in the rehabilitation planning part of the PRC plan and in the proposed final site design.

**Date area is available** - The PRCP schedule must identify when land within the rehabilitation area becomes available for rehabilitation. If the whole rehabilitation area becomes available at once there should be only one date. If the rehabilitation areas becomes available progressively there should be multiple dates. These dates should reflect the information provided in the rehabilitation planning part of the PRC plan.

**Cumulative area available (ha)** - The PRCP schedule must identify the area of land within the rehabilitation area that will become available at a given time.

**Milestone completed by** - The PRCP schedule must identify completion dates for milestones to be completed.

**Cumulative area achieved (ha)** - The PRCP schedule must show how progressive rehabilitation is being achieved over the life of the mine. This section must reflect the proposed rehabilitation work required for the rehabilitation area to achieve stable condition. The milestone reference to be included refers back to the Rehabilitation Area Milestones sheet with the detailed milestone criteria. The milestones must be achieved consecutively.

##### **Headings under Rehabilitation Area Milestones sheet**

**Rehabilitation milestone & Milestone criteria** - The "rehabilitation milestone" is a short description of the rehabilitation activities. The "milestone criteria" must be able to demonstrate achievement of the milestone.

#### **Further Instructions when inputting NUMAs**

##### **Headings under Improvement Area (IA) sheets**

**Improvement area** - The improvement area must align with the spatial information included in the rehabilitation planning part of the PRC plan. This area must have the same NUMA and same milestones applied to the whole area.

**Relevant activities** - The relevant activities must align with the activities identified in the rehabilitation planning part of the PRC plan. The relevant activities are those undertaken within the improvement area prior to land becoming available for improvement.

**Total size (ha)** - Total size of improvement area in hectares.

**Commencement of first milestone** - The applicant must nominate a date for when the first milestone for the improvement area will commence. The milestone reference for the first milestone must be included in the heading.

**NUMA** - The NUMA must align with those identified in the rehabilitation planning part of the PRC plan and in the proposed final site design.

**Date area is available** - The PRCP schedule must identify when land within the improvement area becomes available for improvement. If the whole improvement area becomes available at once there should be only one date. If the improvement areas becomes available progressively there should be multiple dates. These dates should reflect the information provided in the rehabilitation planning part of the PRC plan.

**Cumulative area available (ha)** - The PRCP schedule must identify the area of land within the improvement area that will become available at a given time.

**Milestone completed by** - The PRCP schedule must identify completion dates for milestones to be completed.

**Cumulative area achieved (ha)** - The PRCP schedule must show how progressive improvement is being achieved over the life of the mine. This section must reflect the proposed management work required for the improvement area to achieve sufficient improvement. The milestone reference refers back to the Improvement Area Milestones sheet with the detailed milestone criteria. The milestones must be achieved consecutively.



Post-mining land uses (PMLU)										
Rehabilitation area					RA1					
Relevant activities					Ancillary infrastructure and services					
Total rehabilitation area size (ha)					30.3					
Commencement of first milestone: RM1					10-Dec-48					
PMLU					Native ecosystem					
Date area is available	1/01/48	1/01/50	1/01/51	1/01/53	1/01/59		10/12/xxxx	10/12/xxxx	10/12/xxxx	10/12/xxxx
Cumulative area available (ha)	30.3	30.3	30.3	30.3	30.3					
Milestone completed by	10/12/49	10/12/50	10/12/52	10/12/58	10/12/65		xx/xx/xxxx	xx/xx/xxxx	xx/xx/xxxx	xx/xx/xxxx
Milestone Reference	Cumulative area achieved (ha)									
RM1	30.3									
RM2		30.3								
RM3		30.3								
RM9		30.3								
RM10			30.3							
RM12				30.3						
RM14					30.3					

- 1) Insert new columns to the **yellow table** to include further rehabilitation milestone dates.
- 2) Insert new columns to the **blue table** to match rehabilitation milestone dates.
- 3) Insert new rows to the **blue table** to include additional rehabilitation milestone references.
- 4) Insert the relevant number in the "Milestone reference" column (i.e. RM1).

Post-mining land uses (PMLU)										
Rehabilitation area				RA2						
Relevant activities				Borrow pits and stockpiles						
Total rehabilitation area size (ha)				43.34						
Commencement of first milestone: RM4				1-Jan-48						
PMLU				Low intensity grazing						
Date area is available	1/01/50	1/01/51	1/01/56					10/12/xxxx	10/12/xxxx	10/12/xxxx
Cumulative area available (ha)	43.34	43.34	43.34							
Milestone completed by	10/12/50	10/12/55	10/12/60					xx/xx/xxxx	xx/xx/xxxx	xx/xx/xxxx
Milestone Reference	Cumulative area achieved (ha)									
RM4	43.34									
RM9	43.34									
RM11	43.34									
RM13		43.34								
RM15			43.34							

- 1) Insert new columns to the **yellow table** to include further rehabilitation milestone dates.
- 2) Insert new columns to the **blue table** to match rehabilitation milestone dates.
- 3) Insert new rows to the **blue table** to include additional rehabilitation milestone references.
- 4) Insert the relevant number in the "Milestone reference" column (i.e. RM1).

Post-mining land uses (PMLU)										
Rehabilitation area					RA3					
Relevant activities					Dams and diversion structures					
Total rehabilitation area size (ha)					41.6					
Commencement of first milestone: RM1					1-Jan-48					
PMLU					Low intensity grazing					
Date area is available	1/01/48	1/01/50	1/01/55	1/01/58	1/01/63	10/12/xxxx	10/12/xxxx	10/12/xxxx	10/12/xxxx	10/12/xxxx
Cumulative area available (ha)	41.6	41.6	41.6	41.6	41.6					
Milestone completed by	10/12/49	10/12/54	10/12/57	10/12/62	10/12/67	xx/xx/xxxx	xx/xx/xxxx	xx/xx/xxxx	xx/xx/xxxx	xx/xx/xxxx
Milestone Reference	Cumulative area achieved (ha)									
RM1	41.6									
RM2	41.6									
RM5		41.6								
RM9		41.6								
RM11			41.6							
RM13				41.6						
RM15					41.6					

- 1) Insert new columns to the **yellow table** to include further rehabilitation milestone dates.
- 2) Insert new columns to the **blue table** to match rehabilitation milestone dates.
- 3) Insert new rows to the **blue table** to include additional rehabilitation milestone references.
- 4) Insert the relevant number in the "Milestone reference" column (i.e. RM1).

Post-mining land uses (PMLU)										
Rehabilitation area		RA4								
Relevant activities		Mineralised waste								
Total rehabilitation area size (ha)		20.2								
Commencement of first milestone:RM2		1-Jan-48								
PMLU		Low intensity grazing								
Date area is available	1/01/48	1/01/49	1/01/50	1/01/53	1/01/58		10/12/xxxx	10/12/xxxx	10/12/xxxx	10/12/xxxx
Cumulative area available (ha)	20.2	20.2	20.2	20.2	20.2					
Milestone completed by	10/12/48	10/12/49	10/12/52	10/12/57	10/12/62		xx/xx/xxxx	xx/xx/xxxx	xx/xx/xxxx	xx/xx/xxxx
Milestone Reference	Cumulative area achieved (ha)									
RM2	20.2									
RM6		20.2								
RM9		20.2								
RM11			20.2							
RM13				20.2						
RM15					20.2					

- 1) Insert new columns to the yellow table to include further rehabilitation milestone dates.
- 2) Insert new columns to the blue table to match rehabilitation milestone dates.
- 3) Insert new rows to the blue table to include additional rehabilitation milestone references.
- 4) Insert the relevant number in the "Milestone reference" column (i.e. RM1).

Post-mining land uses (PMLU)										
Rehabilitation area					RA5					
Relevant activities					Mining and processing areas					
Total rehabilitation area size (ha)					201.59					
Commencement of first milestone:RM2					1-Jan-48					
PMLU					Low intensity grazing					
Date area is available	1/01/48	1/01/49	1/01/50	1/01/53		10/12/xxxx	10/12/xxxx	10/12/xxxx	10/12/xxxx	10/12/xxxx
Cumulative area available (ha)	201.59	201.59	201.59	201.59						
Milestone completed by	10/12/48	10/12/49	10/12/52	10/12/57		xx/xx/xxxx	xx/xx/xxxx	xx/xx/xxxx	xx/xx/xxxx	xx/xx/xxxx
Milestone Reference	Cumulative area achieved (ha)									
RM2	201.59									
RM6	201.59									
RM9		201.59								
RM11		201.59								
RM13			201.59							
RM15				201.59						

- 1) Insert new columns to the yellow table to include further rehabilitation milestone dates.
- 2) Insert new columns to the blue table to match rehabilitation milestone dates.
- 3) Insert new rows to the blue table to include additional rehabilitation milestone references.
- 4) Insert the relevant number in the "Milestone reference" column (i.e. RM1).

Post-mining land uses (PMLU)										
Rehabilitation area				RA6						
Relevant activities				Tailings Storage Facility (TSF)						
Total rehabilitation area size (ha)				216.9						
Commencement of first milestone: RM1				1-Jan-48						
PMLU				Native ecosystem						
Date area is available	1/01/48	1/01/49	1/01/50	1/01/52	1/01/57			10/12/xxxx	10/12/xxxx	10/12/xxxx
Cumulative area available (ha)	216.9	216.9	216.9	216.9	216.9					
Milestone completed by	10/12/48	10/12/49	10/12/51	10/12/56	10/12/66			xx/xx/xxxx	xx/xx/xxxx	xx/xx/xxxx
Milestone Reference	Cumulative area achieved (ha)									
RM1	216.9									
RM7		216.9								
RM9			216.9							
RM10			216.9							
RM12				216.9						
RM14					216.9					

- 1) Insert new columns to the **yellow table** to include further rehabilitation milestone dates.
- 2) Insert new columns to the **blue table** to match rehabilitation milestone dates.
- 3) Insert new rows to the **blue table** to include additional rehabilitation milestone references.
- 4) Insert the relevant number in the "Milestone reference" column (i.e. RM1).



Post-mining land uses (PMLU)										
Rehabilitation area					RA7					
Relevant activities					Renewable energy infrastructure					
Total rehabilitation area size (ha)					68.35					
Commencement of first milestone: RM1					1-Jan-48					
PMLU					Native ecosystem					
Date area is available	1/01/50	1/01/51	1/01/52	1/01/52	1/01/55	10/12/xxxx	10/12/xxxx	10/12/xxxx	10/12/xxxx	10/12/xxxx
Cumulative area available (ha)	68.35	68.35	68.35	68.35	68.35					
Milestone completed by	10/12/50	10/12/51	10/12/52	10/12/54	10/12/59	xx/xx/xxxx	xx/xx/xxxx	xx/xx/xxxx	xx/xx/xxxx	xx/xx/xxxx
Milestone Reference	Cumulative area achieved (ha)									
RM1	68.35									
RM2		68.35								
RM8		68.35								
RM9			68.35							
RM10			68.35							
RM12				68.35						
RM14					68.35					

- 1) Insert new columns to the [yellow table](#) to include further rehabilitation milestone dates.
- 2) Insert new columns to the [blue table](#) to match rehabilitation milestone dates.
- 3) Insert new rows to the [blue table](#) to include additional rehabilitation milestone references.
- 4) Insert the relevant number in the "Milestone reference" column (i.e. RM1).

Milestone reference	Rehabilitation milestone	Milestone criteria
RM1	Infrastructure decommissioning and removal	a) All buildings and associated infrastructure dismantled and removed offsite b) All hardstand and concrete areas decommissioned and removed c) Fences are removed d) Pipelines (above and below ground) are removed e) Road base removed (with the exception of those being retained for future site access) f) Waste is removed g) Machinery/ equipment not required for rehabilitation is removed from site h) Powerlines (above and below ground) are removed
RM2	Removal of contaminated land	a) Contaminated land assessment is completed by a suitably qualified person b) Any identified contaminated material is removed from the mine domain and disposed of at a licenced facility c) Validation sampling determines that contaminant removal has been successful d) The validation sampling report is accepted by a suitably qualified Contaminated Land Auditor stating that contamination removal has been successful
RM3	Landform development and reshaping - RA1	a) Landform is shaped to be gently sloping, characteristic of the natural landform with natural drainage lines reinstated b) Landform is ripped parallel to landform c) Features such as large woody debris or boulders are present to provide suitable habitat for the Purple Neck Rock Wallaby d) RA1 is determined to be geotechnically stable by a suitably qualified geotechnical engineer
RM4	Landform development and reshaping - RA2	a) Landform is shaped to be gently sloping, characteristic of the natural landform with natural drainage lines reinstated b) Landform is ripped parallel to landform c) RA2 determined to be geotechnically stable by a suitably qualified geotechnical engineer
RM5	Landform development and reshaping - RA3	a) General earthworks completed b) HPDE Liner removed c) Dams filled with NAF or other suitable material. Material is placed in 500mm lifts, watered and compacted d) Landform is shaped to be gently sloping, characteristic of the natural landform with natural drainage lines reinstated e) RA3 is determined to be geotechnically stable by a suitably qualified geotechnical engineer
RM6	Landform development and reshaping - RA4/RA5	a) Waste rock is removed from surface. PAF is disposed underground. NAF utilised in rehabilitation b) Major earthworks are completed c) Landform is shaped to be gently sloping, characteristic of the natural landform with natural drainage lines reinstated d) RA4/RA5 is determined to be geotechnically stable by a suitably qualified geotechnical engineer

RM7	Landform development and reshaping - RA6	<p>a)The construction of the cover system / cap has been certified by an appropriately qualified person as being consistent with the cover design</p> <p>b)QAQC testing is completed post construction at a rate of at least 1 sample per ha and confirms the depth of layers and permeability is to specified designs and no PAF material is present within the cover system</p> <p>c)Primary monitoring locations have been established in representative locations recommended as an outcome of the trial mentioned in Condition PRCP5(e) and include:</p> <p>I.An automated meteorological station that records the following:</p> <p>i.rainfall (tipping bucket),</p> <p>ii.evaporation,</p> <p>iii.relative humidity,</p> <p>iv.wind strength,</p> <p>v.Wind direction, and</p> <p>vi.air temperature.</p> <p>II.piezometers within the tailings and capillary break layer,</p> <p>III.automated in situ water content and suction sensors in each layer of the cover system and in the tailings below the cover system that records data at 30 minute intervals (except in the capillary break),</p> <p>IV.temperature sensor in each layer of the cover system and in the tailings below the cover system that records data at 30 minute intervals,</p> <p>V.a lysimeter.</p> <p>d)Secondary monitoring locations have been established in representative locations recommended as an outcome of the trial mentioned in Condition PRCP5(e) and include in each layer of the cover system and in the tailings below the cover system:</p> <p>I.piezometers within the tailings and capillary break layer,</p> <p>II.automated in situ water content sensors in each layer of the cover system and in the tailings below the cover system that records data at 30 minute intervals (except in the capillary break).</p> <p>e)Temperature sensor in each layer of the cover system and in the tailings below the cover system that records data at 30 minute intervals. All sensors are calibrated to each material type using the manufacturers specifications</p> <p>f)Lysimeters and associated drainage collection and monitoring system are installed in at least 3 locations that are recommended as an outcome of the trial mentioned in Condition PRCP5(e)</p> <p>g)Sediment capture flumes have been installed and calibrated at the base of the TSF embankment</p> <p>h)All monitoring equipment has been installed and calibrated by an appropriately qualified person</p> <p>i)Slopes of TSF top to have a grade of 1% with slope lengths of ~2000m at the southern end of the TSF, and 1150m at the northern end</p> <p>j)Certification by an AQP that landform has been constructed according to the design and has achieved an acceptable factor of safety</p> <p>k)Main TSF embankment formed as a broad spillway rock chute with slopes of 15% with a slope length of ~230 m</p> <p>l)TSF is assessed as geotechnically stable by a suitably qualified geotechnical engineer</p> <p>m)Features such as large woody debris or boulders are present to provide suitable habitat for the Purple Neck Rock Wallaby</p> <p>n)TSF surface has been shaped to prevent ponding and concentration of surface water flow</p> <p>o)Spillway is designed and constructed to support peak flood flow velocity</p> <p>p)An average erosion rate &lt;5 t/ha/y</p>
RM8	Landform development and reshaping - RA7	<p>a) Where erosion risk is identified, pad crests are rounded to create convex slope profile</p> <p>b) Locally stockpiled material from road and drainage development is reinstated</p>
RM9	Surface preparation	<p>a)Deep ripping of compacted surfaces, at least 300mm into soil profile, where required and avoiding habitat features associated with RM3</p> <p>b)An assessment of the need for soil amelioration undertaken and soil ameliorants such as fertiliser, gypsum and/or organic matter have been applied at rates determined by an appropriately qualified person</p> <p>c)Topsoil placement of a minimum 0.2 m, where required</p>
RM10	Revegetation (native ecosystem)	<p>a)Seeding rate of 4 – 10 kg/ha is applied</p> <p>b)Direct seeding species mix is endemic to Regional Ecosystem 1.11.2 and 1.7.7 on RA1 including Eucalyptus leucophloia, Corymbia terminalis, Corymbia capricornia with a groundcover of Aristida latifolia, Eriachne obtusa, Sporobolus australasicus, Themeda triandra, Triodia pungens</p> <p>c)Direct seeding species mix is endemic to Regional Ecosystem 1.11.2 and 1.7.7 on RA6 including Aristida latifolia, Eriachne obtusa, Sporobolus australasicus, Themeda triandra, Triodia pungens.</p> <p>d)Direct seeding species mix is endemic to Regional Ecosystem 1.11.2a/1.7.7a and RE1.11.3a/1.3.13a on RA7, including Eucalyptus leucophloia, Corymbia terminalis and Corymbia capricornia with a groundcover of Aristida latifolia, Eriachne obtusa, Sporobolus australasicus, Themeda triandra and Triodia pungens. □</p> <p>e)Deep rooting vegetation such as Eucalyptus Spp not present on RA6</p> <p>f)Groundcover &gt;50%</p>
RM11	Revegetation (grazing)	<p>a)Pasture vegetation seeding creates cover &gt;30%</p> <p>b)Direct seeding of native species including Eucalyptus leucophloia, Corymbia capricornia, Terminalia aridicola, Corymbia terminalis, Triodia pungens, Eucalyptus pruinose, Eremophila longifolia, Atalaya hemiglauca, Acacia chisholmi, Atalaya hemiglauca, Carissa lanceolata as well as appropriate 3P grass species to support the PMLU</p> <p>c)Direct seeding is applied at a rate of 4 – 10 kg/ha</p>

<p>RM12</p>	<p>Achievement of surface requirements (native ecosystem)</p>	<p>For all areas:  a) Weed species in densities less than 10% total coverage  b) Average erosion rate of &lt;5 t/ha/y  c) Vegetation cover 70%  d) Species used in revegetation in RM 9 remain present and showing evidence of natural recruitment  e) Surface water quality measured at downstream monitoring sites (CT3-08 (MS2), CC-05, CC-15, MS8 (SN-15), SC-29 (MS5) and DR-18) undertaken on an event basis 1 complies with ANZECC/ARMCANZ (2000) Table 3.4.1 for 95% protection level and Table 3.3.4 values for aquatic ecosystems (slightly to moderately disturbed)  f) Stream sediment quality at downstream monitoring sites (CT3-08 (MS2), CC-05, CC-15, MS8 (SN-15), SC-29 (MS5) and DR-18) undertaken twice a year (at end of wet season and end of dry season) complies with ANZECC/ARMCANZ (2000) Interim Sediment Quality Guidelines – low  g) Quarterly groundwater monitoring at MB5, MB6, MB9S and MB9D demonstrate groundwater quality complies with groundwater trigger limits nominated in Schedule C – Table 8 of the EA  h) Soil testing indicates the following parameters are met:  I. Rootzone EC &lt;0.15mS/cm,  II. Soil pH &lt;9 and &gt;6 as measured at any part of the root zone,  III. Exchangeable Sodium Percentage (ESP%) &lt;5% (at 0-10cm depth).  For RA6:  i) There is no evidence of water ponding on the surface of the TSF  j) Continuous recording demonstrates seepage volume is decreasing  k) Seepage is collected and disposed of at an appropriately licensed facility  l) In-situ permeability and surface infiltration are not significantly decreasing compared with initial rates based on statistical analysis</p>
<p>RM13</p>	<p>Achievement of surface requirements (grazing)</p>	<p>a) Weed species in densities less than 10% total coverage  b) Pasture covers has reached 70% of surface area  c) Average erosion rate of &lt;5 t/ha/y with the maximum erosion rate at any point on the landform of &lt;10 t/ha/y  d) Surface water quality measured at downstream monitoring sites (CT3-08 (MS2), CC-05, CC-15, MS8 (SN-15), SC-29 (MS5) and DR-18) undertaken on an event basis complies with ANZECC/ARMCANZ (2000) Table 3.4.1 for 95% protection level and Table 3.3.4 values for aquatic ecosystems (slightly disturbed)  e) Stream sediment quality at downstream monitoring sites (CT3-08 (MS2), CC-05, CC-15, MS8 (SN-15), SC-29 (MS5) and DR-18) undertaken twice a year (at end of wet season and end of dry season) complies with ANZECC/ARMCANZ (2000) Interim Sediment Quality Guidelines – low  f) Quarterly groundwater monitoring at MB5, MB6, MB9S and MB9D demonstrates groundwater quality complies with groundwater trigger limits nominated in Schedule C – Table 8 of the EA  g) Soil testing indicates the following parameters are met:  I. Rootzone EC &lt;0.15mS/cm,  II. Soil pH &lt;9 and &gt;6 as measured at any part of the root zone,  III. Exchangeable Sodium Percentage (ESP%) &lt;5% (at 0-10cm depth).</p>

RM14	Achievement of post-mining land use to a stable condition (	<p>•For all areas:</p> <p>a)Vegetation cover exceeds 70% of the surface area  b)All species used in RM9 show natural recruitment  c)Weed species in densities less than 10% total coverage  d)Native fauna observed or indicators of these species have been recorded  e)There is no evidence of seepage occurring within the mining tenure  f)Certification from an REPQ that the domain has achieved stable condition  g)Certification from an AQP that the landform achieved a factor of safety 1.5  h)All results from surface water quality measured at downstream monitoring sites (CT3-08 (MS2), CC-05, CC-15, MS8 (SN-15), SC-29 (MS5) and DR-18) undertaken on an event basis complies with ANZECC/ARMCANZ (2000) Table 3.4.1 for 95% protection level and Table 3.3.4 values for aquatic ecosystems (slightly disturbed) for a minimum of 5 consecutive years  i)All results from stream sediment quality at downstream monitoring sites (CT3-08 (MS2), CC-05, CC-15, MS8 (SN-15), SC-29 (MS5) and DR-18) undertaken twice a year (at end of wet season and end of dry season) complies with ANZECC/ARMCANZ (2000) Interim Sediment Quality Guidelines – low for a minimum of 5 consecutive years  j)All results from quarterly groundwater monitoring at MB5, MB6, MB9S and MB9D demonstrate groundwater quality complies with groundwater trigger limits nominated in Schedule C – Table 8 of the EA for a minimum of 5 consecutive years  k)Soil testing undertaken at yearly intervals indicates the following parameters are met:  I.Rootzone EC &lt;0.15mS/cm,  II.Soil pH &lt;9 and &gt;6 as measured at any part of the root zone,  III.Exchangeable Sodium Percentage (ESP%) &lt;5% (at 0-10cm depth).  For RA1:  l)No evidence of erosion classified as 'Severe'  m)No active erosion present as demonstrated by no increase in erosion ratings over time  For RA6:  n)There is no evidence of water ponding on the surface of the TSF  o)Average erosion rate of &lt;5 t/ha/y  p)No evidence of erosion classified as 'moderate' or 'severe'  q)No evidence of salt rise through the cover system of the TSF  r)In-situ permeability and surface infiltration are not significantly decreasing compared with initial rates based on statistical analysis  s)Results of monitoring gathered from primary and secondary monitoring stations established in RM7 demonstrate the following has been maintained for a minimum of 10 years:  I.Hydraulic conductivity of the cover system is less than 1 x 10-8 m/s for at least 10 years,  II.Net percolation through the cover into the tailings has been reduced to &lt;5% of rainfall for at least 10 years as measured by primary and secondary monitoring locations and lysimeters,  III.Water content of the reduced permeability layer is maintained above 85% over a 10 year period,  IV.Temperature within the tailings has not increased over a 10 year period</p>
RM15	Achievement of post-mining land use to a stable condition (	<p>a)Weed species in densities less than 10% total coverage  b)Vegetation cover has reached 70%  c)All established species show natural recruitment  d)Land suitability assessment by an appropriately qualified person certifies land has achieved a post-mine land suitability of 4 or better  e)Minimum of 4 palatable perennial pasture species and 2 shade tree species established  f)No evidence of erosion classified as 'Severe'  g)No active erosion present as demonstrated by no increase in erosion ratings over time  h)There is no evidence of seepage occurring within the mining tenure  i)Certification from an REPQ that the domain has achieved stable condition  j)Certification from an AQP that the landform achieved a factor of safety 1.5  k)All results from surface water quality measured at downstream monitoring sites (CT3-08 (MS2), CC-05, CC-15, MS8 (SN-15), SC-29 (MS5) and DR-18) complies with ANZECC/ARMCANZ (2000) Table 3.4.1 for 95% protection level and Table 3.3.4 values for aquatic ecosystems (slightly to moderately disturbed) for a minimum of 5 consecutive years  l)All results from stream sediment at downstream monitoring sites (CT3-08 (MS2), CC-05, CC-15, MS8 (SN-15), SC-29 (MS5) and DR-18) undertaken twice a year (at end of wet season and end of dry season) complies with limits set for low risk and no adverse effects in ANZECC/ARMCANZ (2000) Interim Sediment Quality Guidelines – low for a minimum of 5 consecutive years  m)All results from quarterly groundwater monitoring at MB5, MB6, MB9S and MB9D demonstrate groundwater quality complies with groundwater trigger limits nominated in Schedule C – Table 8 of the EA for a minimum of 5 consecutive years  n)Soil testing undertaken at yearly intervals indicates the following parameters are met:  I.PAWC &gt;50 at Red Plain and Pocket soil types,  II.Rootzone EC &lt;0.15mS/cm,  III.Soil pH &lt;9 and &gt;6 as measured at any part of the root zone,  IV.Exchangeable Sodium Percentage (ESP%) &lt;5% (at 0-10cm depth),  V.Carrying capacity is suitable to support a sustainable level of grazing.</p>

- 1) Insert new rows below the table to record more Rehabilitation Area Milestones for the project
- 2) Ensure all Rehabilitation Milestones recorded in this table align with those included in the RA sheets in this form.

3) See the PRCP guideline before developing site-specific Rehabilitation Area Milestones



Milestone reference	Management milestone	Milestone criteria
MM1		
MM2		
MM3		
MM4		
MM5		
MM6		
MM7		
MM8		
MM9		
MM10		

1) Insert new rows below the table to record more Improvement Area Milestones for the project  
2) Ensure all Management Milestones recorded in this table align with those included in the IA sheets in this form.  
3) See the PRCP guideline before developing site-specific Improvement Area Milestones

## Appendix B: Dugald River TSF Revised Concept Design



**REPORT**

**MMG DUGALD RIVER**

**Tailings Storage Facility**

**Revised Concept Design**

**July 2015**

**Doc. No. 108003.20-R01**

## Document History and Status

**Title:** Dugald River TSF- Revised Concept Design  
**Job Number/Extension** 108003.20  
**Document Number:** 108003.20-R01  
**Last Printed:** 29 July 2015  
  
**File Path:** J:\2008\108003 Dugald River\20 Revised TSF Concept Design\Reports\R01\Text\108003.20-R01.docx  
  
**Author:** Craig Noske  
**Reviewer:** Keith Seddon  
**Job Manager:** Craig Noske

Rev.	Status	Issued to	Issue Date	Signatures	
				Author	Reviewer
0	Final	MMG	29.07.15	CN	KDS

This Revision distributed To:	Hard Copy	Electronic Copy
MMG Dugald River	-	<input checked="" type="checkbox"/>
ATCW Melbourne Office	-	On network

**CRAIG NOSKE**  
 Author

**KEITH SEDDON**  
 Reviewer

**IMPORTANT NOTICE**  
 Please refer to our Conditions of Report on Following Page



ATC Williams Pty Ltd  
 222 Beach Road (P.O. Box 5286) Mordialloc Vic 3195  
 T +61 3 8587 0900 F +61 3 8587 0901  
 melb@atcwilliams.com.au

ATC Williams unites the companies of Australian Tailings Consultants and MPA Williams & Associates



## CONDITIONS OF REPORT

### Conditions of Report

1. This report has been prepared by us for the purposes stated herein. We do not accept responsibility for the consequences of extrapolation, extension or transference of the findings and recommendations of this report to different sites, cases or conditions.
2. This report is based in part on information which was provided to us by the client and/or others and which is not under our control. We do not warrant or guarantee the accuracy of this information.
3. We believe the conclusions and recommendations contained herein were reasonable and appropriate at the time of issue of the report. However, the user is cautioned that fundamental input assumptions upon which this report is based may change with time. It is the user's responsibility to ensure that input assumptions remain valid.
4. This report must be read in its entirety. This notice constitutes an integral part of the report, and must be reproduced with every copy.
5. This report is prepared solely for the use of the person or company to whom it is addressed. No responsibility or liability to any third party is accepted for any damages howsoever arising out of the use of this report by any third party.
6. Unless specifically agreed otherwise in the contract of engagement, ATC Williams retains Intellectual Property Rights over the contents of this report. The client is granted a licence to use the report for the purposes for which it was commissioned.



ATC Williams Pty Ltd  
222 Beach Road (P.O. Box 5286) Mordialloc Vic 3195  
T +61 3 8587 0900 F +61 3 8587 0901  
melb@atcwilliams.com.au

ATC Williams unites the companies of Australian Tailings Consultants and MPA Williams & Associates



## EXECUTIVE SUMMARY

### 1. GENERAL

Mineral and Metals Group ((MMG) is developing its Dugald River Project, located in Queensland, approximately 70km northwest of Cloncurry. Dugald River is a zinc-lead deposit with the presence of copper mineralisation. Detailed design of a TSF located in a natural valley to the west of the proposed Dugald River process plant was completed by ATC Williams (ATCW) in 2013. The revised concept design described in this Report has been based on the outcomes of recent TSF options assessments, together with more recent mining and processing developments conducted by MMG during the first half of 2015.

### 2. STUDY PARAMETERS

Dugald River will be an underground mining operation using paste backfill on an ongoing basis. The staging and rate of filling of the TSF has been based on a total tonnage of tailings (plus pre-float concentrate) pumped to the TSF of 12.6 Mt. This includes 38% of the total tailings production of 20.4 Mt, the rest of which will go to paste backfill.

The tailings will be thickened to a target solids content of 55% at discharge, and a conservative final insitu dry density of 1.5 t/m<sup>3</sup> has been adopted. The required TSF capacity is thus 8.39 million m<sup>3</sup>.

### 3. KNAPDALE VALLEY TSF LAYOUT

The TSF site is a long, narrow bifurcated valley running north-south on the western side of the Knapdale Ranges. The valley is approximately 4 km north-west of the process plant. Tailings will be pumped to the Knapdale Ranges from the process plant, via the Mine Village access road route. The TSF concept will involve down-valley discharge of tailings from the northern and southern ends of the valley over the life of mine to create a self-shedding profile for rehabilitation and closure.

All decant and runoff water collecting on the tailings beach will be conveyed back to the processing plant by a pontoon mounted pump. Confinement for the TSF is achieved by the construction of a 37 m high embankment within the valley outlet on the western side.

### 4. CONSEQUENCE CATEGORY AND REGULATORY DESIGN CRITERIA

Based on the current DEHP Guidelines, the TSF has been preliminarily classified as Significant Consequence Category with respect to Dam Break and Failure to Contain - Overtopping. This represents a reduction from the previous High Consequence Category, and results in a reduced Design Storage Allowance (DSA) for the TSF, from a 1 : 100 AEP to a 1: 20 AEP, 2 month wet season rainfall. This results in a DSA of 2,600 ML for the TSF. The guidelines state that the facility must have available a sufficient volume on 1<sup>st</sup> November of any year to store the DSA.

### 5. TSF WATER BALANCE & EMBANKMENT ARRANGEMENTS

A preliminary water balance model of the final TSF beach was developed to generate a probability distribution of the maximum decant pond volume on 1<sup>st</sup> November. Based on a conservative 90% probability of occurrence once during the mine life, a pond value of 1,500 ML was obtained. This value was added to the DSA of 2,600 ML plus an additional freeboard of 1.5 m to achieve a final embankment crest elevation of 243.1 m.

The 37 m high embankment will be constructed of rockfill and granular materials in two stages, with a waterproofing geomembrane sealing system on the upstream face. The start-up Stage 1 will provide approx. 7 years of storage, at which time Stage 2 will be constructed to provide the 27 years of total storage required.



## 6. CLOSURE AND REHABILITATION

Due to the characteristics of the tailings, the low design filling rate and the water management arrangements, closure of the Knapdale Valley TSF will be able to commence as soon as processing of tailings ceases and the decant pond has been dewatered. The tailings profile within the TSF will have a final surface that will be self-shedding, thereby allowing closure of the TSF without the need for major re-shaping of the tailings surface.

As the tailings will be potentially acid forming, closure must ensure that a suitable protective cover be placed over the tailings to inhibit the adverse environmental impacts of such potential acid generation. The general approach to closure will incorporate a low water flux cover system consisting of a capillary break, sealing layer, waste rock layer and revegetated topsoil.

The downstream slope of the TSF Embankment will be flattened and rehabilitated to a concave slope, to act as a broad spillway chute sized to pass the peak flood resulting from the Probable Maximum Precipitation (PMP).

## 7. DISCUSSION OF RISKS

The adopted TSF operational methodology involves the combined storage of tailings and process water within a valley closed-off by the construction of a tailings and water retaining embankment. Whilst it is accepted that this is not a method usually considered best practice, in this instance it is believed to be an appropriate and defensible approach, given the unique nature of the selected TSF site.

From a risk perspective, there are considered to be three primary issues. All of these are considered to be suitably accounted for in the design of the TSF, by recognising and making use of particular site characteristics and operational methodologies. These three issues are:

- (i) TSF seepage containment;
- (ii) TSF spillway discharge due to inadequate flood capacity; and
- (iii) Loss of TSF capacity due to inability to achieve design tailings density.

### Seepage Containment

The Knapdale Valley TSF concept does not include impoundment lining, relying instead on the natural characteristics of the site, and the proposed operational methodology as a means of impoundment seepage containment.

The structural geology of the Knapdale valley has been assessed, and there is no evidence of significant defects which could extend from the TSF. There is hence very little risk of significant seepage occurring through the Knapdale Range rock mass, into the adjacent Cabbage Tree catchment.

The Knapdale Range does not have an identified groundwater resource. Investigations within the valley drainage outlet and the valley floor have shown the potential for infiltration of tailings leachate to the Knapdale quartzite rock mass will be low. There is considered to be negligible risk of contamination to the hydrogeological regime as a result of low permeability tailings overlying intrinsically low permeability strata, and leachate or process water will not contaminate surface water in the region.

During TSF operation, it is expected that the near-surface (upper 5 m) rock mass will slowly saturate. The zone of saturation will, over time, expand along preferential seepage paths into the underlying less permeable foundation zone. However, flow will become unsaturated beyond this depth, due to the decrease in rock mass fracturing and jointing. The only means of seepage within this locally saturated zone exiting the Knapdale Valley will be through the drainage outlet on the western side. At this location the water-retaining Main Embankment will be constructed, including a fully intercepting grout curtain at the upstream toe, which will fully penetrate the upper 10 m of the foundation profile.

### **TSF Spillway Discharge**

The risk of the TSF spillway discharging due to inadequate flood capacity could only reasonably occur during the final year of each TSF Embankment stage (Year 7 and Year 27), when the flood capacity is reduced to the design condition. At all other times during the operational life, the TSF will have flood capacity far exceeding the DSA plus maximum allowable 1<sup>st</sup> November volume. Even during those two specific years, a spillway discharge would only result if the following events occur:

- Sustained, inadequate process water pumping return to the plant; and/or
- Lack of DSA provision on the 1<sup>st</sup> November, followed by a 2 month wet season rainfall greater than designed for.

It is recognised that return water pumping must be a firm commitment, documented in the Operation and Maintenance Manual for the TSF.

As a Regulated Structure, mandatory annual audits of flood capacity will be required. Regular monitoring of TSF inputs/outputs will allow the water balance model to be calibrated with time, such that the behaviour of the TSF will become well understood. This will allow adjustments to the Main Embankment raising schedule, and adjustments to the tailings and process water management procedures, well in advance of any issue arising.

There is hence considered to be negligible risk of an unforeseen failure to contain scenario due to spillway discharge over the operating life of the TSF.

### **Failure To Achieve Design Tailings Density**

In general the density of tailings increases with time. Consolidation is a time dependent process whereby water is “squeezed” from the pore spaces in the tailings due to their self-weight. Tailings density increases with depth, however, the rate of density increase is affected by the permeability of the tailings and rate of discharge. As deposition continues, the addition of tailings will eventually lead to further consolidation and resultant increase in density.

For design purposes, the Overall Insitu Density is used to estimate the required capacity. In a well-designed TSF the Overall Insitu Density will approach the Shrinkage Limit Density, which is the limiting density achieved at the surface when subject to solar desiccation. Given that the Dugald River TSF will quickly develop a relatively large beach area, it would normally be reasonable to assume that a this limiting density will be achieved virtually throughout. However, given decant and runoff storage over the tailings, the density must be de-rated to reflect the occurrence of sub-aqueous deposition conditions.

The analysis of consolidation behaviour is complex, as it is a time dependent phenomenon that is governed by tailings permeability. Thus if the rate of rise in the TSF is too rapid there will be insufficient time for the tailings at depth to respond and low densities can persist. Analyses previously completed by ATCW indicate that the tailings will be at least normally consolidated during the majority of the deposition period, and that there will be minimal post deposition settlement. This is due to the overall low rate of rise of the deposited tailings and the relatively rapid consolidation characteristics obtained for the tailings laboratory testing.

The TSF design has been based on an Overall Insitu Density value of 1.5 t/m<sup>3</sup>. ATCW consider this to be conservative, based on the now lower expected rate of rise and the results of the consolidation modelling. However, adoption of this density is considered a sound, defensive design policy given that the TSF will be configured to temporarily store catchment runoff and bleed water on the tailings.

Based on the above discussion, there is considered to be negligible risk of the deposited tailings not achieving the design density, irrespective of the frequency of process water pond inundation.

## TABLE OF CONTENTS

1	INTRODUCTION.....	1
2	BACKGROUND .....	1
	2.1 Previous Studies.....	1
	2.2 2014 Review of Site and Design Options.....	1
3	STUDY PARAMETERS.....	2
	3.1 2015 Basis of Revised Design .....	2
	3.2 Tailings Tonnage and Thickening .....	2
	3.3 Design Density.....	2
	3.4 Required TSF Capacity .....	3
	3.5 Tailings Beach Slope.....	4
	3.6 Climate Data.....	4
4	SITE CONDITIONS .....	4
	4.1 Knapdale Valley Description.....	4
	4.3 Geotechnical Information .....	5
	4.3.1 Overview .....	5
	4.3.2 Subsurface Conditions.....	5
	4.3.3 Groundwater .....	5
	4.3.4 Embankment Construction Materials.....	5
	4.4 Hydrogeology.....	6
	4.4.1 Knapdale Valley Quartzite.....	6
	4.4.2 Cabbage Tree Creek Catchment.....	6
5	CONSEQUENCE CATEGORY AND REGULATORY DESIGN CRITERIA.....	6
	5.1 Preliminary Consequence Category Assessment.....	6
	5.1.1 Overview .....	6
	5.1.2 Methodology .....	6
	5.1.3 Preliminary Assessment Outcomes .....	7
	5.2 Regulatory Design Criteria.....	8
	5.2.1 DEHP Requirements .....	8
	5.2.2 Design Storage Allowance .....	9
	5.2.3 Adopted Flood Capacity and Crest Level.....	9
	5.2.4 Flood Freeboard.....	9
6	PRELIMINARY WATER BALANCE .....	9
	6.1 Methodology .....	9
	6.2 Objectives .....	10
	6.3 Catchment Runoff Overview .....	10
	6.4 Process Water Return .....	10
	6.5 Adopted 1 <sup>st</sup> November Process Water Pond Volume .....	10
7	EMBANKMENT CREST HEIGHT & STAGING .....	11
	7.1 Overview .....	11
	7.2 Outcomes .....	11
8	KNAPDALE VALLEY TSF.....	11
	8.1 Tailings Storage Concept .....	11
	8.2 Main Embankment .....	12

8.2.1	Design Overview .....	12
8.2.2	Embankment Stability .....	13
8.2.3	Embankment Quantities .....	13
8.3	Tailings Management .....	13
8.4	Water Management .....	14
8.4.1	Process Water Return .....	14
8.4.2	Decant Pond Operation .....	14
8.4.3	Emergency Spillways .....	14
9	CLOSURE AND REHABILITATION .....	15
9.1	Overview .....	15
9.2	TSF Closure Design .....	15
10	DISCUSSION OF RISKS .....	16
10.1	Overview .....	16
10.2	Seepage Containment .....	16
10.3	TSF Spillway Discharge .....	17
10.4	Failure To Achieve Design Tailings Density .....	18
10.4.1	Overview .....	18
10.4.2	Consolidation .....	19
11	CLOSURE .....	20
	REFERENCES .....	21

## LIST OF FIGURES

- FIGURE 1 Process Water Pond Maximum Volume on 1<sup>st</sup> November for Each Realisation
- FIGURE 2 Tailings Deposition and Embankment Crest Staging
- FIGURE 3 TSF Stage 1 General Layout at End of Filling (Year 7)
- FIGURE 4 TSF Stage 2 General Layout at End of Filling (Year 27)
- FIGURE 5 Typical Main Embankment Section and Materials Summary
- FIGURE 6 TSF Closure Concept
- FIGURE 7 Knapdale Valley Structural Geology & Hydrogeology - Sections

## 1 INTRODUCTION

This report describes a revised concept for the Tailings Storage Facility (TSF) for the Dugald River Project, located approximately 70 km north-west of Cloncurry in north-west Queensland.

The project is being developed by MMG Limited (MMG), and will use conventional mechanised underground technology to mine zinc, lead and silver.

The basis of the revised concept design has been the outcomes of a Site and Design Options assessment [Ref. 1] completed by ATCW in January 2015, together with more recent mining and processing developments conducted by MMG during the first half of 2015.

## 2 BACKGROUND

### 2.1 Previous Studies

ATC Williams (ATCW) have carried out a series of tailings management studies for the Dugald River Project since 2008, which have examined up to eight potential sites for the tailings storage, and considered a number of different tailings management methodologies.

One of the preferred TSF sites initially identified was a natural valley located within the Knapdale Range on the western side of the mine lease. More detailed site options and feasibility studies were concluded in February 2009 with a geotechnical investigation of the Knapdale Range site, which by then had become known as “Site A”.

After MMG acquired the project, ATCW recommenced feasibility-level design of the preferred Site A in May 2010. This study adopted a configuration referred to as “Site A2”, involving tailings discharge from both ends of the Knapdale Valley, with the decant pond forming over the tailings in the centre.

A comprehensive qualitative comparison of the TSF options was then developed in conjunction with MMG and the Queensland Department of Environment and Heritage Protection (DEHP, formerly DERM). Upon completion of this assessment, the decision was made to adopt the “Site A1” TSF configuration, which involved the Site A valley sub-divided into a TSF and a separate process water dam. The final feasibility study for the Site A1 TSF and PWD configuration was then completed in August 2011, based on the storage of 22.8 Mt of tailings.

Detailed design of the TSF was completed by ATCW in 2013 [Ref. 2]. During the design phase it became apparent that the required TSF capacity would be reduced due to an increased project requirement for tailings used in the underground mine as paste backfill. The detailed design was hence based on a tailings inventory of 9.5 Mt over a 21.5 year mine life (which represented 30% of the total production estimate).

### 2.2 2014 Review of Site and Design Options

During 2014, MMG undertook a comprehensive review of all aspects of the project, with ATCW engaged in November 2014 to conduct a value engineering review of the Dugald River TSF. The objective was the identification of a lower capital cost solution for tailings storage under a revised mining scenario with paste backfill demands significantly increased to 80% of tailings production (and a commensurate significant reduction in the required TSF capacity).

This study [Ref. 1] identified four viable TSF and associated process water management configurations. These were assessed in a broader context, with the outcome being a clear preference for a Site A Knapdale Valley TSF configuration based on the 2010 Feasibility Study arrangements, i.e. tailings discharge from both ends of the Knapdale Valley, with no dividing embankment such that the decant pond forms over the tailings in the centre of the TSF.

### 3 STUDY PARAMETERS

#### 3.1 2015 Basis of Revised Design

During the first half of 2015, MMG have been undertaking a project-wide review and redesign of key components to produce an Updated Development Plan. The outcome of the TSF options assessment [Ref. 1] has been added to the scope of this Plan.

MMG have also conducted further work with respect to mine planning and scheduling, which has resulted in a change in the required quantity of tailings paste backfill, and the addition of process plant pre-float concentrate as an additional storage requirement. The basis of the conceptual redesign of the TSF has hence been based upon the following:

- Total resource to be milled = 38.2 Mt over 27 years (nominal rate = 1.5 Mtpa).
- Total tailings production = 20.4 Mt, of which 62% (overall) will go to paste backfill.
- Pre-float concentrate (PFC) directed to TSF = 4.8 Mt.
- Total tailings plus PFC pumped to the TSF = 12.6 Mt.

#### 3.2 Tailings Tonnage and Thickening

The annual process plant throughputs, PFC production and proportion of tailings to the TSF are summarised in **Table 3.1**.

High-rate thickening of tailings will be conducted at the process plant, and the tailings will be delivered to the TSF using conventional centrifugal pumps. From process design information provided by MMG for this study, the target thickener underflow solids content will be nominally 55%, which is only marginally higher than the criteria used in the [Ref. 2] design.

#### 3.3 Design Density

For design purposes, the Overall Insitu Density (OID) is used to estimate the required capacity of the TSF. In a well-designed TSF the OID will approach the Shrinkage Limit Density, which is the limiting density that tailings will achieve at the surface when subject to solar desiccation. Desiccation occurs when the rate of evaporation exceeds the rate at which consolidation water is expelled from the tailings surface.

In accordance with the studies documented in [Ref. 2], the required TSF capacity for this revised concept has been based on an OID value of 1.5 t/m<sup>3</sup>.

Given that the annual tailings tonnage directed to the TSF has decreased since this density was evaluated, it is now likely to be conservative. However, given the addition of PFC, it is considered a sound, defensive design policy to adopt a lower-bound density.



MMG have recently commissioned ATCW to conduct a laboratory testing program of both tailings and PFC samples. The outcomes of this testwork will be used to re-evaluate the OID estimate for detailed design purposes.

### 3.4 Required TSF Capacity

The annual process plant throughputs, PFC production and proportion of tailings to the TSF are summarised in Table 3.1. The proportion of tailings to the TSF and the density used in the estimate of required capacity are described in the previous sections.

**Table 3.1  
Dugald River - Revised Production and Annual Tailings to TSF Data**

Year	Milled Ore	Tailings Produced	Tailings to Paste	Tailings to TSF	PFC to TSF	Total Tailings + PFC to TSF (tonnes)		Cumulative TSF Capacity
	(Mtpa)	(tpa)	(tpa)	(tpa)	(tpa)	Annual	Cumulative	(m <sup>3</sup> )
2018	1.45	493,420	98,340	395,090	181,100	576,190	576,190	384,120
2019	1.55	833,140	168,010	665,120	194,400	859,520	1,435,710	957,140
2020	1.5	809,200	319,840	489,360	188,810	678,180	2,113,890	1,409,260
2021	1.4	746,340	197,380	548,960	174,150	723,100	2,836,990	1,891,320
2022	1.5	802,350	360,090	442,260	187,210	629,470	3,466,460	2,310,970
2023	1.55	828,990	439,960	389,020	193,430	582,450	4,048,910	2,699,270
2024	1.45	785,740	321,600	464,140	183,340	647,480	4,696,390	3,130,930
2025	1.5	808,950	452,260	356,690	188,760	545,440	5,241,830	3,494,550
2026	1.6	851,330	497,940	353,390	198,640	552,030	5,793,860	3,862,570
2027	1.6	857,250	533,780	323,470	200,020	523,490	6,317,350	4,211,570
2028	1.55	825,690	549,620	276,070	192,660	468,730	6,786,080	4,524,060
2029	1.6	862,130	548,700	313,430	201,160	514,600	7,300,680	4,867,120
2030	1.5	819,870	457,690	362,190	191,300	553,490	7,854,170	5,236,110
2031	1.55	827,200	536,700	290,500	193,010	483,520	8,337,690	5,558,460
2032	1.55	824,310	508,070	316,230	192,340	508,570	8,846,260	5,897,510
2033	1.5	815,470	472,830	342,640	190,280	532,910	9,379,170	6,252,780
2034	1.55	838,550	457,690	380,860	195,660	576,520	9,955,700	6,637,130
2035	1.5	812,150	414,560	397,590	189,500	587,090	10,542,790	7,028,530
2036	1.55	826,680	480,250	346,440	192,890	539,330	11,082,120	7,388,080
2037	1.45	789,440	676,090	113,360	184,200	297,560	11,379,680	7,586,450
2038	1.5	817,160	714,520	102,640	190,670	293,310	11,672,990	7,781,990
2039	1.3	694,100	653,750	40,350	161,960	202,310	11,875,290	7,916,860
2040	1.5	822,160	799,090	23,070	191,840	214,910	12,090,200	8,060,130
2041	1.45	791,130	764,120	27,020	184,600	211,610	12,301,810	8,201,210
2042	1.25	665,580	665,580	0	155,300	155,300	12,457,120	8,304,740
2043	0.8	438,060	427,900	10,160	102,210	112,370	12,569,490	8,379,660
2044	0.15	70,530	70,530	0	16,460	16,460	12,585,950	8,390,630
<b>27</b>	<b>38.2</b>	<b>20,356,900</b>	<b>12,586,870</b>	<b>7,770,030</b>	<b>4,815,910</b>	<b>12,585,950</b>		

In summary, the TSF will need to be designed with a storage capacity of 8.4 million m<sup>3</sup>, in order to contain the following:

- 7.8 Mt of tailings, at rate of 287 ktpa (average), 665 ktpa (max);
- 4.8 Mt of PFC, at rate of 178 ktpa (average), 201 ktpa (max);
- 12.6 Mt in total, at rate of 466 ktpa (average), 860 ktpa (max).

### 3.5 Tailings Beach Slope

This is the slope formed by the tailings after deposition, and impacts upon embankment requirements and thus cost. The slope depends upon the tailings discharge solids content, segregation threshold and rheology. From previous studies the segregation limit is known to be well below the expected discharge solids content, which indicates that there will be little or no segregation or sorting on the beach.

In practice, the underflow solids concentration from the tailings thickeners will vary from day to day. The variation depends on many factors such as fluctuations in feed rate, flocculant behaviour, ore type, and operational decisions. The outcome is a slightly concave beach profile as the lower density tailings will beach at the toe of the slope at the flattest angle and the highest density tailings will beach at the head of the beach at the steepest angle.

In accordance with the studies documented in [Ref. 2], the “rule of thirds” has been applied to the overall average slope to account for the concave effect. This results in the following beach profile, on the basis of a maximum of two discharge points operating at any one time:

- Top 1/3 of beach : 1.5 %
- Middle 1/3 of beach : 1.0 %
- Bottom 1/3 of beach : 0.67 %

### 3.6 Climate Data

The daily rainfall and evaporation data used in water balance modelling, together with the statistical analysis of rainfall data for flood storage modelling for this study, have all been obtained from the ATCW Rainfall Analysis and Water Balance Modelling Report [Ref. 3].

## 4 SITE CONDITIONS

### 4.1 Knapdale Valley Description

The Site A Knapdale Valley alley is well documented from previous feasibility-level and detailed designs (all of which are documented in Ref. 2). The valley is bifurcated and of a shape which leads to high storage efficiency for a down-valley tailings discharge scheme.

The valley is some 3,000 m long, and is generally less than 500 m wide within the tailings storage area. The sides of the valley are generally quite steep, with a perimeter level generally in excess of RL 260 m. The valley floor, by comparison, is relatively flat, with its level ranging from a low point of RL 207 m to RL 235 m at the southern end.

The valley has a catchment area of 338 hectares. The eastern side of the catchment extends across the Knapdale plateau for a distance up to 700 m, whilst the western side ridge line rises more abruptly before dropping down to the western toe of the ranges.

The single drainage outlet is a relatively narrow valley approximately mid-way along the western side. This valley runs some 600 m before reaching the western extent of the ranges and discharging into the Cabbage Tree Creek catchment.

## **4.2 Geology**

The 14 km long, 3 km wide Knapdale Range consists of Knapdale Quartzite of the Mount Albert Group, which overlies the Corella Formation calc-silicates. Separating the quartzite from the Corella Formation is a low angle, mylonitic thrust fault.

The quartzite is a massive formation of medium grained, pink-grey metamorphosed sandstone, striking predominantly north-south with a dip of foliation angle in the range 60 to 80 degrees to the west. There are no known faults running through the valley.

## **4.3 Geotechnical Information**

### **4.3.1 Overview**

Geotechnical investigations within the Knapdale Valley have been conducted in two phases and have included borehole drilling, in-situ permeability testing, installation of groundwater monitoring wells, test pit excavations and bulk sampling for subsequent laboratory characterisation of potential construction materials. Detailed reporting of the investigations programs and results are documented in **Ref. 2**.

### **4.3.2 Subsurface Conditions**

The Knapdale Valley consists of thin deposits of sandy, gravelly topsoil overlying 5 m of moderate strength, highly fractured, moderately weathered quartzite. The weathered quartzite rock is considered a satisfactory foundation material for the proposed TSF Embankment in terms of strength and deformation potential.

The fracturing of the rock decreases over the 5 m to 10 m depth range, and insitu testing has revealed it to have an overall low permeability.

### **4.3.3 Groundwater**

Groundwater within the Knapdale Valley is confined to the joints and defects within the rock mass, typically within a depth of 10 m below the surface of the gully floor. The level is also known to fluctuate seasonally.

### **4.3.4 Embankment Construction Materials**

Based on the investigation results, the quartzite within the Knapdale Valley can be expected to yield suitable rockfill for embankment construction. Granular materials of alluvial, colluvial and residual schist origin are prevalent on the floor and foot-hills of the valley, whilst gravel-sized quartzite materials will be available from the upper profile of the rockfill quarries.

Lower permeability clayey, silty, sandy gravel deposits on the base of the TSF impoundment and the lower slopes are potentially suitable for use as granular fill, particularly if screening and/or processing methods are utilised.

#### 4.4 Hydrogeology

##### 4.4.1 Knapdale Valley Quartzite

A number of hydrogeological assessments of the Knapdale Valley site have been conducted, all of which are documented in **Ref. 2**.

There are no significant aquifers within the Knapdale Quartzite. The mylonitic fault which separates the quartzite from the Corella Formation to the east is considered to form a low permeability groundwater disconnect. Minor perched zones occur in the upper 10 m of the quartzite formation where unloading fractures occur. However, due to the nature of the quartzite formation, the groundwater exists only locally in the fissures within the rock mass. Below this depth the formation is massive and essentially unfractured.

##### 4.4.2 Cabbage Tree Creek Catchment

As with the Knapdale Range, the utilisation of groundwater within the Cabbage Tree Creek catchment area to the west has been very limited. However, the lack of production bores or wells in the area suggest it is a poor groundwater resource.

## 5 CONSEQUENCE CATEGORY AND REGULATORY DESIGN CRITERIA

### 5.1 Preliminary Consequence Category Assessment

#### 5.1.1 Overview

In order to ensure regulatory compliance with the Queensland Department of Environment and Heritage Protection (DEHP), a preliminary assessment of Consequence Category has been completed for the Dugald River TSF.

The review has been completed in accordance with the most recent published DEHP guidelines, “Manual for Assessing Hazard Categories and Hydraulic Performance of Dams” [**Ref. 4**]. It is important to note that the previous assessment conducted for the Site A1 TSF and PWD scheme [**Ref. 2**] which arrived at a ‘High’ consequence category, was based on different DEHP criteria which are now superseded by [**Ref. 4**].

All structures which are dams associated with the operation of an environmentally regulated activity must have their consequence category assessment based on the potential environmental harm that would result from potential failure event scenarios.

The consequence category will determine whether the structure is a Regulated Structure. A structure is only a Regulated Structure where the consequence category for the structure is ‘Significant’ or ‘High’.

#### 5.1.2 Methodology

The consequence category for the TSF has been assessed on the following failure event scenarios:

- (i) ‘Failure to contain - seepage’ - spills or releases to ground and/or groundwater via seepage from the floor and/or sides of the structure;
- (ii) ‘Failure to contain - overtopping’ - spills or releases from the structure that result from loss of containment due to overtopping of the structure; and
- (iii) ‘Dam break’ - collapse of the structure due to any possible cause.

Three categories of harm are considered for each failure scenario. Their definitions and requirements to constitute a ‘High’ consequence category are summarised in **Table 5.1**.

**Table 5.1**  
**DEHP (Nov 2013) Consequence Category Assessment Criteria**

Harm Category	General Definition	‘High’ Consequence Criteria
Harm to Humans	Either by being present in the failure path during a dam break, or due to contamination of drinking water.	Loss of life > 10 people; or Health of > 20 people affected by consumption of contaminated water.
General Environmental Harm	Contamination with adverse effects to environmentally significant waters.	Contamination of waters resulting in adverse effects to areas of State Environmental Significance or High Ecological Value, and causing damage either: requiring > \$50M or ≥ 3 years to remediate; to an area > 5 km <sup>2</sup> ; or permanent alteration to existing ecosystems.
General Economic Loss or Property Damage	Financial (or other than above two categories) harm to third party assets.	Harm to third party assets in the failure path requiring > \$10M in rehabilitation, compensation, repair or rectification costs.

The overall consequence category to be applied for a structure is the highest category determined under the above failure event assessments. Consequence categories for each failure scenario are subsequently used to determine the appropriate hydraulic performance criteria for the structure.

### 5.1.3 Preliminary Assessment Outcomes

The outcomes of the TSF preliminary consequence category assessment for the three failure event scenarios are presented in **Table 5.2**. It can be seen that the outcome of the assessment under the Failure to Contain - Overtopping and Failure to Contain - Dambreak scenarios is “Significant”.

This is based on the expected extent of the affected area due to a spillway discharge or dambreak release, and the duration and cost of remedial works. The downstream receiving area for a dam break event is the Cabbage Tree Creek catchment, and the following is noted:

- Non-itinerant people are not routinely present in the failure path. Itinerants would be limited to dam inspections personnel, all of which will be suitably trained in areas of dam safety awareness.
- Contamination of water used for human consumption would not occur following an overtopping or dambreak event from the proposed TSF system.
- There are no areas of human habitation, infrastructure developments or rare/endangered species located anywhere within the general Cabbage Tree Creek Catchment area downstream of the storage.

- Based on a review of the Queensland Government Department of Infrastructure, Local Government and Planning “SPP Interactive Mapping System”, potential areas of “Significant Values” which may suffer adverse effects are confined to the Cabbage Tree Creek watercourse itself. These are defined as “MSES regulated vegetation (intersecting a watercourse)”.

**Table 5.2  
Knapdale Valley TSF - Preliminary Consequence Category Assessment**

Failure Scenario	Harm Category	Consequence Category	Rationale
Failure to Contain - Seepage	Harm to humans	LOW	No loss of life or risk to health.
	General environmental	LOW	No risk of contamination causing adverse effects meeting the threshold for Significant or High.
	General economic loss	LOW	No risk of harm to third party assets costing > \$1M.
Failure to Contain - Overtopping	Harm to humans	LOW	No loss of life or risk to health.
	General environmental	SIGNIFICANT	Potential for contamination causing adverse effects, but not meeting the threshold for High.
	General economic loss	LOW	No risk of harm to third party assets costing > \$1M.
Dambreak	Harm to humans	LOW	No loss of life or risk to health.
	General environmental	SIGNIFICANT	Potential for contamination causing adverse effects, but not meeting the threshold for High.
	General economic loss	LOW	No risk of harm to third party assets costing > \$1M.

## 5.2 Regulatory Design Criteria

### 5.2.1 DEHP Requirements

The consequence category of a dam dictates the level of safety as applied to the operation, maintenance and surveillance requirements, together with the required detail of engineering design and the recurrence intervals of rainfall events and earthquakes for flood capacity and seismic stability analyses.

The Failure to Contain - Overtopping consequence category is used in the assessment of the dam containment/flood storage requirements, whilst the Dam Break consequence category is used for the spillway design and the assessment of flood freeboard and embankment crest levels.

The most important flood storage requirement is the Design Storage Allowance (DSA), defined as the available volume to be provided in a dam as at the 1<sup>st</sup> November each year in order to prevent a discharge from that dam up to a specified annual exceedance probability (AEP).

Based on the DEHP [Ref. 4] procedures and the preliminary assessments outlined in Table 5.2, the following design criteria apply:

- (i) Wet Season Containment (DSA) -
  - Significant consequence AEP = 1 : 20 AEP
  - Wet season duration = 2 months

- (ii) Emergency Spillway Capacity -
  - Significant consequence AEP = 1 : 1,000 AEP (critical duration)
- (iii) Flood Freeboard for Embankment Crest Level -
  - Significant consequence AEP = Spillway peak flood level  
+ wave run-up for 1 : 10 wind

## 5.2.2 Design Storage Allowance

Based on the climate data referred to in **Section 3.6**, the design rainfall depth for the DSA calculation is 776 mm.

The calculation of the DSA is simply the catchment area multiplied by the rainfall, with no allowance for catchment losses, and assuming that process inputs are counterbalanced by process outputs.

For the 338 hectare catchment, assuming no runoff losses or pond evaporation, with net process inputs (tailings bleed water - process water return) set to zero, the DSA is estimated to be 2,600 ML.

## 5.2.3 Adopted Flood Capacity and Crest Level

In order to estimate the required volume in the storage (and hence the necessary embankment crest level) the DSA is added to a representative storage volume assumed to be in the storage system at the 1<sup>st</sup> November.

The estimation of the 1<sup>st</sup> November volume is based on statistics and risk, as there is no guidance provided by the DEHP in **[Ref. 4]**. The adopted design approach is to conduct preliminary water balance modelling to derive probability outcomes for the 1<sup>st</sup> November water pond volume. For the Knapdale Valley TSF the basis of design has been to select a 1<sup>st</sup> November volume with a probability of occurring not greater than once in the 27 year Life Of Mine (LOM).

The modelling conducted to estimate this 1<sup>st</sup> November volume is described in **Section 6**.

## 5.2.4 Flood Freeboard

The design flood freeboard is added to the DSA level to obtain the required embankment crest level. This study has conservatively adopted the 2013 detailed design **[Ref. 2]** freeboard of 1.5 m which was based on a “High” Consequence Category.

# 6 PRELIMINARY WATER BALANCE

## 6.1 Methodology

For the purposes of this concept design, the daily, life of mine water balance previously developed for the 2013 detailed design was adapted and simplified. The preliminary water balance was run with 973 realisations utilising the 1,000 years of synthetic climate data, as described in **[Ref. 3]**. The model was prepared on the basis of the conventional mass balance approach:

$$\Delta \text{ Storage Volume} = \text{Inputs} - \text{Outputs}$$



Inputs have included tailings bleed and catchment runoff, whilst outputs were limited to process water return and evaporation, with seepage assumed to be zero given the expected low permeability of the tailings and valley floor.

Further discussion of tailings bleed is provided in [Ref. 3].

## 6.2 Objectives

The primary objective of the preliminary water balance was to determine a sufficiently representative 1<sup>st</sup> November volume to estimate the required embankment crest height at the end of deposition.

As such, the preliminary water balance was run using only a static tailings beach surface geometry over the 27 year life of mine. The beach surface at the end of mine life filling was selected, as this generates the highest catchment yield and hence the most conservative volume outcomes. This is a simplified approach, as it does not require the complications involved in modelling the filling of the TSF over time, together with the changing characteristics of the process water pond on top of the rising tailings beach.

## 6.3 Catchment Runoff Overview

In the preliminary water balance model, runoff from the following catchment areas report to the process water pond:

- The TSF "Catchment Surrounds"
- The TSF "Dry Beach Area"
- The TSF "Active and Passive Wet Beach Area"
- The TSF "Process Water Pond Area"

The "Wet Beach Area" is a function of the "Total Beach Area", the "Process Water Area" and the initial and final settled densities of the deposited tailings. The area is subdivided into "Active" and "Passive" wet beach areas, with the former considered to be the area covered by the previous day's deposited tailings, and susceptible to evaporation. The Total Beach Area was set as a constant 65.9 hectares, which is the beach surface at the end of mine life filling.

In order to provide a rational basis for determination of runoff from the catchment surrounds, catchment yield parameters were derived as detailed in [Ref. 3], in order to provide an overall average yield factor of 0.35.

## 6.4 Process Water Return

Based on process plant mass balance data provided by MMG, a process water return pump capacity of 70 m<sup>3</sup>/hr has been adopted for this study, equivalent to 1.7 ML/day.

## 6.5 Adopted 1<sup>st</sup> November Process Water Pond Volume

As described in Section 5.2.4, a risk based approach using statistics has been used to adopt a representative storage volume assumed to be in the storage system at the 1<sup>st</sup> November. The maximum 1<sup>st</sup> November volume from each of the 973 life of mine preliminary water balance simulations was ordered and ranked. A probability distribution of Maximum November 1<sup>st</sup> volumes was compiled, with the results as shown in Figure 1.

A 90% probability of occurrence once over the 27 year LOM (equating to an 8% AEP) has been adopted, which results in a maximum 1<sup>st</sup> November volume of approximately 1,500 ML.

## 7 EMBANKMENT CREST HEIGHT & STAGING

### 7.1 Overview

The procedure to estimate the final embankment crest level was introduced in **Section 5.2** and can be summarised as follows:

- (i) The adopted 1<sup>st</sup> November volume (1,500 ML) is overlaid on the final tailings beach surface at the end of filling;
- (ii) The DSA (2,600 ML) is added to the adopted 1<sup>st</sup> November storage volume. The water level required to store this combined volume over the final tailings beach is adopted as the final embankment spillway level;
- (iii) The design flood freeboard (taken to be 1.5 m) is then added to the DSA level to obtain the required final embankment crest level.

### 7.2 Outcomes

The conceptual embankment staging schedule will be as follows:

- Stage 1 - Crest level RL 235.5 m. This is the crest level needed at start-up to contain 7 years of tailings production, plus the required flood and freeboard provision - resulting in an embankment height of approximately 29.5 m.
- Stage 2 - Final crest level RL 243.1 m. This will involve a 7.6 m downstream raise of the embankment to contain the remaining life of mine tailings, plus the required flood and freeboard provision - resulting in a final embankment height of approximately 37.1 m.

**Figure 2** presents the staging of the embankment with tailings deposition over the life of the mine, together with the required flood and freeboard provision.

## 8 KNAPDALE VALLEY TSF

### 8.1 Tailings Storage Concept

An overall site plan of the Stage 1 Knapdale Valley TSF is shown in **Figure 3**, whilst the general arrangement of the TSF at the end of mine life is shown in **Figure 4**. The tailings storage concept is relatively simple, and makes use of the inherent characteristics of the valley. Tailings will be pumped up into the Knapdale Ranges from the process plant, initially making use of the Mine Village access road route. From there the pipeline will divide into the northern and southern arms as shown in **Figures 3** and **4**.

Discharge will occur from both the south-eastern and north-eastern ends of the valley, such that the tailings beach low point is maintained in the centre of the valley, where the decant pond will form. Decant return will be via a floating pontoon pump tethered on the eastern side of the valley. A decant return pipeline and access road will be required to link the eastern side of the TSF to the Mine Village access road, as shown in **Figures 3** and **4**.

Containment of tailings and decant pond water will almost entirely be provided by the valley topography, with the only retaining feature to be constructed being the 37 m high Main Embankment, in order to close the valley outlet on the western side. It will need to be designed and constructed as a water retaining embankment, due to the presence of water ponding against it during the life of mine. The embankment will be raised downstream in two stages to minimise upfront capital costs.

The TSF valley has a catchment of 338 hectares, with no diversion drains proposed. This large catchment is however a potential benefit of the site, in that it can be used to collect and temporarily store runoff during the wet season for use in the process plant.

At the end of mine life, the final beach profile will have its low-point at the Main Embankment, as shown in **Figure 4**. Thus, a self-shedding profile will be created for rehabilitation and closure.

## 8.2 Main Embankment

### 8.2.1 Design Overview

As outlined in [Refs 1 & 2], the conventional clay core option has not been preferred for the TSF Main Embankment, on the basis of capital cost and uncertainty regarding the availability of suitable low permeability earthfill materials.

Instead, a rockfill embankment fitted with a waterproofing geomembrane sealing system (GSS) on the upstream face has been selected. A typical section and materials summary for the GSS rockfill embankment option are shown in **Figure 5**. The general embankment design comprises an exposed PVC geocomposite anchored to a supporting layer of Zone 2B clayey, silty, sandy gravel with a maximum particle size of 50 mm. The GSS face anchorage is subject to detailed design, but would comprise either:

- Continuous vertical lines of anchor strips embedded in trenches backfilled with porous concrete in the embankment face; or
- Deep, punctural anchors (either duck-bill or grouted bars) in a regular (say 5m x 5m) grid pattern.

This represents a simplified and more cost efficient GSS face anchorage system to that which was adopted for the 2013 detailed design [Ref. 2]. Perimeter anchorage would consist of mechanical tie-down to a concrete plinth at the upstream toe, as per the 2013 detailed design.

With respect to the GSS itself, the same system selected during the 2013 detailed design process [Ref. 2] has been adopted for the purposes of this concept design. This incorporates a PVC geocomposite, which will be a 2.0 mm to 2.5 mm thick PVC geomembrane, laminated during fabrication to a 500 g/m<sup>2</sup> non-woven polypropylene geotextile. Further discussion regarding the details and selection process for this system is given in [Ref. 2].

The remainder, and bulk of the embankment raise, would consist of Zone 3A and 3B quarried rockfill. The rockfill provides strength and stability to the structure and supports the upstream GSS. The rockfill zones would differ on the basis of maximum allowable particle size, placed layer thickness and the compaction requirements.

In order to prevent seepage through the upper 5 m to 10 m of fractured rock, the embankment foundation will require curtain grouting, as per the 2013 detailed design.

The embankment side slopes would be 1.5 : 1 (horiz : vert) upstream, and 1.75 : 1 (overall) downstream, as shown in **Figure 5**. The downstream seepage collection pond from the 2013 detailed design has been retained for this study.

### 8.2.2 Embankment Stability

The static and seismic stability of the Main Embankment has not been reassessed for this concept design. The results from previous the 2013 detailed design [**Ref. 2**] show the stability of the adopted embankment configuration and materials to be satisfactory under all relevant loading conditions.

### 8.2.3 Embankment Quantities

A summary of major quantities relating to civil earthworks construction of the TSF Main Embankment is presented in **Table 8.1**.

**Table 8.1**  
**Summary Of TSF Main Embankment Civil Earthworks Quantities**

	TSF Main Embankment (m <sup>3</sup> )			Geomembrane (m <sup>2</sup> )
	Zone 2B Granular Fill	Zone 3A/3B Rockfill	Total	
Stage I (Year 0)	51,100	124,100	175,200	6,440
Stage II (Year 7)	22,100	93,100	115,200	2,780
<b>Total</b>	<b>73,200</b>	<b>217,200</b>	<b>290,400</b>	<b>9,220</b>

### 8.3 Tailings Management

Tailings management within the Knapdale Valley TSF will be operationally straight-forward, which is one of the beneficial features of the scheme. Tailings deposition will occur from the northern and southern ends of the valley via end-point discharge from the points shown in **Figures 3** and **4**. The tailings beaching effect discussed in **Section 3.5** will be exploited together with the long, narrow configuration of the valley to create a sub-aerially deposited, essentially desaturated tailings storage.

The northern and southern discharge points (one at the northern end and eventually three at the southern end) will generally be operated on a rotational basis in order to maintain the decant pond adjacent to the Main Embankment where the return pump will be located. Based on the adopted tailings properties and production rates, the maximum discharge head of beach will be approximately RL 251 m at the southern end, and RL 243 m at the northern end.

The maximum tailings depth within the TSF will be approximately 23 m, and the overall rate of rise will average 1.5 m per year for the first 10 years, decreasing to an average of 0.4 m per year over the final 17 years of filling. Rates of rise of this order are considered beneficial with respect to achieving optimum density in the deposited tailings.

## 8.4 Water Management

### 8.4.1 Process Water Return

The water accumulating in the TSF is to be re-utilised within the process plant and various other mine activities (dust sprays, mine service water streams, etc.). It was identified during the 2013 detailed design that a means of utilising additional quantities of decant water was beneficial for the overall management of the TSF system, particularly with respect to the volume of water remaining in the storage at the end of operations.

It is important to understand that a critical component of the Knapdale Valley TSF water management is the adequate provision of process water return. Without the incorporation of a pumping station capable of returning 60 to 100 m<sup>3</sup>/hr (equivalent steady state) from the TSF, the modelling reported in [Ref. 3] clearly shows that the valley is a net accumulator of water. Similar outcomes were also revealed in the preliminary water balance described in Section 6, with the adopted return rate of 70 m<sup>3</sup>/hr preventing the life of mine water volume from accumulating.

It is hence strongly recommended that project planning involve the incorporation of a suitably sized return water pumping station.

From an operational perspective, it is important to recognise that the water balance modelling [Ref. 3] has shown that large fluctuations in the ponded water volume can be expected, and that the pond may dry up for extended periods of time when low rainfall climatic conditions prevail. There are hence periods where there is no return water available to the process plant, meaning that water will be required from other sources.

### 8.4.2 Decant Pond Operation

The tailings deposition methodology will allow decant water management to occur from a static location in the centre of the TSF, adjacent to the Main Embankment. The decant return system will consist of a pump mounted on a floating pontoon towards the eastern side of the TSF, where the decant return pipeline and access road will be located. It will be tethered at the toe of the active tailings beach, and incrementally shifted east along the decant access road at a reducing frequency to suit the decreasing tailings rate of rise.

It will be an important operational aspect to manage the tailings beach deposition in a manner which maintains the decant pond centrally around the decant pontoon.

The water balance modelling has shown that large fluctuations in pond level can be expected, and that high wet season runoff will likely result in many months of sustained high water pond volumes in the TSF. These outcomes will need to be catered for in the final design of the decant return system and tethering arrangements.

### 8.4.3 Emergency Spillways

Each of the two stages of the Main Embankment will need to be equipped with an emergency spillway. As outlined in Section 5.2, for a Significant consequence category, as a minimum the spillway will need to be capable of safely passing the critical duration, 1 : 1,000 AEP flood event.

These spillways will be located on the embankment abutments, and based on the 2013 detailed design [Ref. 2], which was based on a 1 :10,000 AEP flood, the spillways will need to be in the vicinity of 5 m wide and 1.0 m to 1.5 m deep.

## 9 CLOSURE AND REHABILITATION

### 9.1 Overview

Due to the characteristics of the tailings, the low design filling rate and the water management arrangements, closure of the Knapdale Valley TSF will be able to commence as soon as processing of tailings ceases and the decant pond has been dewatered.

The tailings profile within the TSF will have a final surface that will be self-shedding, thereby allowing closure of the TSF without the need for major re-shaping of the tailings surface.

### 9.2 TSF Closure Design

The TSF closure and rehabilitation closure works from the 2013 detailed design [Ref. 2] have been adopted for this concept design. As discussed in [Ref. 2], the tailings will be potentially acid forming. Closure must ensure that a suitable protective cover be placed over the tailings to inhibit the adverse environmental impacts of such potential acid generation.

A conceptual cover strategy and nominal layer depths, based on current available guidelines and mine sites in similar climates would include the following, in sequence from the tailings surface:

- (i) Capillary Break (0.3 m depth) - mainly coarse, non-acid forming waste rock placed directly over the tailings. The purpose of this layer is to prevent the rise of salts from the underlying tailings to the sealing layer above.
- (ii) Sealing Layer (0.5 m depth) - low permeability compacted earthfill constructed above the capillary break layer to limit water infiltration. This material may need to be sourced from either the non-acid forming weathered waste rock dumps or general earthfill borrow pits located within the project boundaries.
- (iii) Waste Rock Cover (1.0 m minimum depth) - A low water flux cover system will be constructed over the sealing layer consisting of a non-acid forming waste rock layer. Waste rock will be loosely paddock dumped over the sealing layer and then roughly smoothed out with a dozer to encourage infiltration without pooling. Some TSF options will require additional thickness of waste rock cover to provide a final landform that is self-shedding.
- (iv) Embankment Slope Modification - To stabilise the TSF Embankment in the long-term, the downstream face will be flattened to nominally 6.5 : 1 (horiz : vert) to direct storm water flows off the rehabilitated TSF Embankment in a controlled manner.

The downstream slope will in effect be reconstructed as a broad spillway chute sized to pass the peak flood resulting from the Probable Maximum Precipitation (PMP).

- (iv) Topsoil and Revegetation - soil stripped from within the impoundment area at the time of construction will be placed on top of the cover system. Good quality topsoil within the majority of the TSF site areas is scarce and therefore is unlikely to be sufficient to cover the entire surface. Topsoil will need to be spread thinly and in patches depending on the quantities available.

A concept plan and section for the closure and rehabilitation concept is presented as **Figure 6**.



## 10 DISCUSSION OF RISKS

### 10.1 Overview

As described in **Section 8** of this Report, the adopted TSF operational methodology involves the combined storage of tailings and process water within a valley closed-off by the construction of a retaining embankment designed to retain tailings and process water.

Whilst it is accepted that the storage of water on tailings is not a method usually considered best practice, in this instance it is considered to be an entirely appropriate and defensible approach, given the unique nature of the selected TSF site.

From a risk perspective, there are considered to be three primary issues. All of these are considered to be suitably accounted for in the design of the TSF, by recognising and making use of particular site characteristics and operational methodologies. These three issues are defined below, and discussed in the following sections:

- (v) TSF seepage containment;
- (vi) TSF spillway discharge due to inadequate flood capacity; and
- (vii) Loss of TSF capacity due to inability to achieve design tailings density.

### 10.2 Seepage Containment

The Knapdale Valley TSF concept does not include impoundment lining, relying instead on the natural characteristics of the site, and the proposed operational methodology as a means of impoundment seepage containment. This has been based upon the following:

Site Characteristics:

- The Knapdale Range does not have an identified groundwater resource. Groundwater is locally restricted to the defects within the rock mass.
- The adjacent groundwater resource (Cabbage Tree Creek catchment) to the west of the Knapdale Range is of poor quality and not considered significant.
- As shown in **Figure 3** and **Figure 7**, the Cabbage Tree Creek resource is separated from the TSF by 500 m to 600 m of Knapdale Ranges quartzite, which rise to levels generally at least 40 m above the final tailings surface.
- From groundwater and permeability investigations within the valley drainage outlet and the valley floor (refer to **Section 4**), the potential for infiltration of tailings leachate to the Knapdale Quartzite will be low. There is considered to be negligible risk of contamination to the hydrogeological regime as a result of low permeability tailings overlying intrinsically low permeability strata, and leachate will not contaminate surface water in the region.
- Given that the valley drainage outlet is considered to be a zone of structural weakness within the Knapdale Quartzite, the western ridge line is expected to consist of a less fractured, and hence lower permeability rock mass than that which was investigated within the drainage outlet.
- The bedding of the quartzite dips steeply to the west. The bedding is typically many metres thick, with no evidence of preferential flow paths along the bedding planes.



- The latter two points have been studied in the field by ATCW's Principal Engineering Geologist, who has concluded in [Ref. 2] that the lineaments identified within the Knapdale valley are not representative of significant defects which could extend to the TSF. There is hence very little risk of significant seepage occurring from the TSF, through the Knapdale Range rock mass, which could impact the adjacent Cabbage Tree catchment.

#### TSF Operational Methodology:

- From tailings consolidation modelling [Ref. 2], the deposited tailings will have a saturated permeability profile averaging between  $10^{-7}$  and  $10^{-8}$  m/s.
- Tailings will be beached from both ends of the valley, forming a low permeability barrier over the valley floor, limiting seepage flux into the underlying rock mass. As a result, decant water will only come into contact with the impoundment at the edges of the tailings surface.
- A system of sub-regional groundwater monitoring bores will be installed downstream of the Main Embankment to the west of the facility, as part of a site-wide groundwater monitoring strategy. It would be proposed that these will be read on a monthly basis.
- The purpose of these bores will initially be to provide data on the presence, depth, quality and flow direction of groundwater in the area. During operations, they will provide an indication of broad scale groundwater fluctuations, such that any impacts on the groundwater regime brought about by the TSF can be monitored.

#### Operational Expectations:

The following is an overview of the expected seepage containment regime during the operation of the TSF. Reference is made to the sections and elevations presented in **Figure 7**.

- During TSF operation, it is expected that the near-surface (upper 5 m) rock mass will slowly saturate.
- The zone of saturation will, over time, expand along preferential seepage paths into the underlying (5 m to 15 m depth) less permeable foundation zone. However, flow will become unsaturated beyond this depth, due to the decrease in rock mass fracturing and jointing.
- The only means of seepage within this locally saturated zone exiting the TSF valley will be through the drainage outlet on the western side. At this location the water-retaining Main Embankment will be constructed, including a 15 m deep grout curtain at the upstream toe, which will fully penetrate the upper 15 m of the foundation profile.
- The zone of saturation will be confined to the valley floor, as evident in **Figure 7**. Seepage will not be able to flow out of the valley elsewhere along the western valley profile, due to the height of the western valley ridge line.

### 10.3 TSF Spillway Discharge

The risk of the TSF spillway discharging due to inadequate flood capacity could only reasonably occur during the final year of each TSF Embankment stage (Year 7 and Year 27), when the flood capacity is reduced to the design condition. At all other times during the operational life, the TSF will have flood capacity far exceeding the DSA plus maximum allowable 1<sup>st</sup> November volume described in **Section 7** above.

Even during those two specific years, a spillway discharge would only result if the following events occur:

- Sustained, inadequate process water pumping return to the plant; and/or
- Lack of DSA provision on the 1<sup>st</sup> November, followed by a 2 month wet season rainfall greater than designed for.

There is no doubt that TSF operational and monitoring procedures will need to be strictly adhered to during the filling life. Return water pumping must be a firm commitment, and will be documented in the Operation and Maintenance Manual for the TSF.

As a Regulated Structure, mandatory annual audits of flood capacity will be required by the DEHP. Regular monitoring of the meteorological data will be conducted at the TSF, together with catchment yield response and process input monitoring. This will allow the water balance model to be calibrated with time, such that by Year 7 the behaviour of the TSF will be well understood. This will allow adjustments to the Main Embankment raising schedule, and adjustments to the tailings and process water management procedures, well in advance of any issue arising.

Based on the above discussion, there is considered to be negligible risk of an unforeseen failure to contain scenario due to spillway discharge over the operating life of the TSF.

## 10.4 Failure To Achieve Design Tailings Density

### 10.4.1 Overview

In general the density of tailings increases with time. The increase in density is a result of three processes: sedimentation, desiccation and consolidation. Consolidation is a time dependent process whereby water is “squeezed” from the pore spaces in the tailings due to their self-weight.

Consolidation is accepted to commence when sedimentation is complete. Tailings density increases with depth, however, the rate of density increase is affected by the permeability of the tailings and rate of discharge. As deposition continues, the addition of tailings will eventually lead to further consolidation and resultant increase in density.

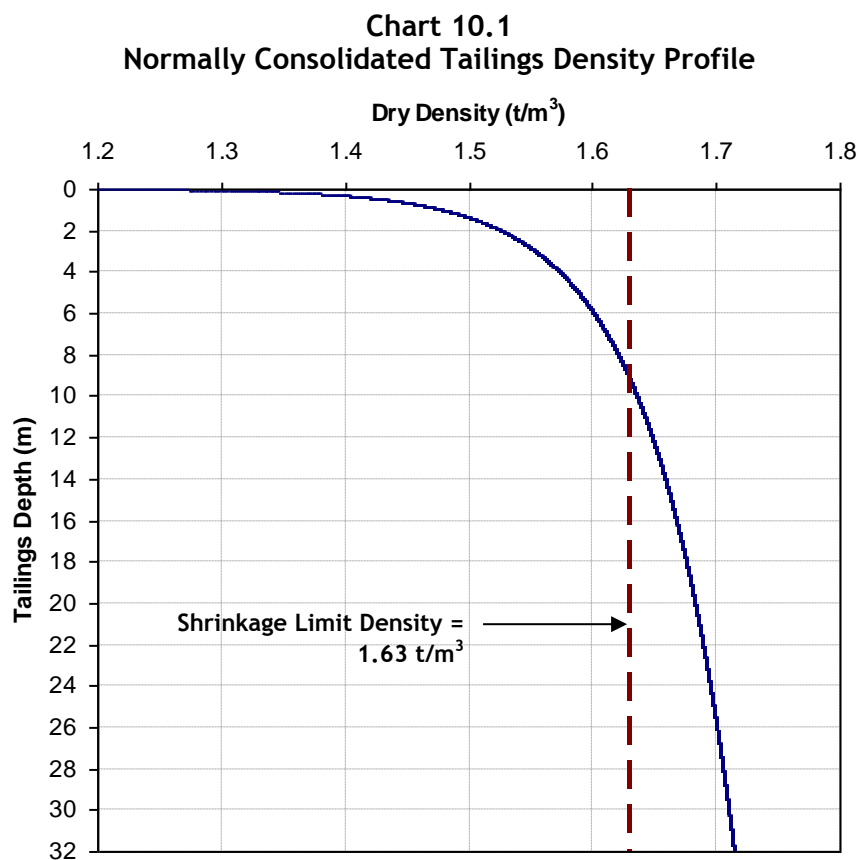
For design purposes, the Overall Insitu Density is used to estimate the required capacity of the TSF. In a well-designed TSF the Overall Insitu Density will approach the Shrinkage Limit Density, which is the limiting density that tailings will achieve at the surface when subject to solar desiccation. In the case of the Dugald River TSF, the theoretical beach area needed to dry the tailings back to the shrinkage limit density can be calculated and is less than 10 ha. In practice it will of course require more in winter and less in summer.

A beach area of 10 ha will be achieved after less than a year of operation. Thus it would normally be reasonable to assume for design purposes that a density at or close to the shrinkage limit density will be achieved virtually throughout. However, as discussed in **Section 8**, the Dugald River TSF concept will involve decant and runoff storage over the tailings, with extended periods of elevated pond levels predicted. The density must therefore be de-rated to reflect the occurrence of sub-aqueous deposition conditions within the decant pond.

### 10.4.2 Consolidation

Consolidation testing and analyses were conducted as part of previous studies for Dugald River, as described in [Ref. 2]. The analysis of consolidation behaviour is complex, as it is a time dependent phenomenon that is governed by tailings permeability. Thus if the rate of rise in the TSF is too rapid there will be insufficient time for the tailings at depth to respond and low densities can persist.

Chart 10.1 presents the computed dry density profile for the tailings adjacent to the Main Embankment at the end of mine life. The shrinkage limit density is also shown in Chart 10.1.



It should be noted that the analysis results were based on a previous TSF option for the Knapdale Valley which involved a similar tailings/process water management configuration, but a higher rate of rise. The outcomes are hence considered conservative for the purposes of the current TSF concept described herein.

It is evident that the tailings will be at least normally consolidated during the majority of the deposition period, and that there will be minimal post deposition settlement. This is due to the overall low rate of rise of the deposited tailings and the relatively rapid consolidation characteristics obtained for the tailings laboratory testing.

The typical depth of tailings required to exceed the shrinkage limit density is approximately 9 m. Under normal operating conditions the dry beach area will develop a crust relatively quickly, and desiccation, accompanied by surface cracking, will commence.

It is important to note that the consolidation profile shown in **Chart 10.1** assumes constant surface water ponding, and neglects the desiccation effects of evaporative drying on the exposed beach. If the Shrinkage Limit Density is superimposed on the density profile, it can be expected that most of the shallow tailings will achieve a significantly higher density than the normally consolidated profile, as a direct consequence of evaporative drying.

As previously described in **Section 3.3**, the TSF design has been based on an Overall Insitu Density value of 1.5 t/m<sup>3</sup>. Whilst this appears conservative based on the results of the consolidation modelling, it is considered a sound, defensive design policy given that the TSF will be configured to temporarily store catchment runoff and bleed water on the tailings.

Based on the above discussion, there is considered to be negligible risk of the deposited tailings not achieving the design density, irrespective of the frequency of process water pond inundation.

## **11 CLOSURE**

An Executive Summary is provided at the front of this report.

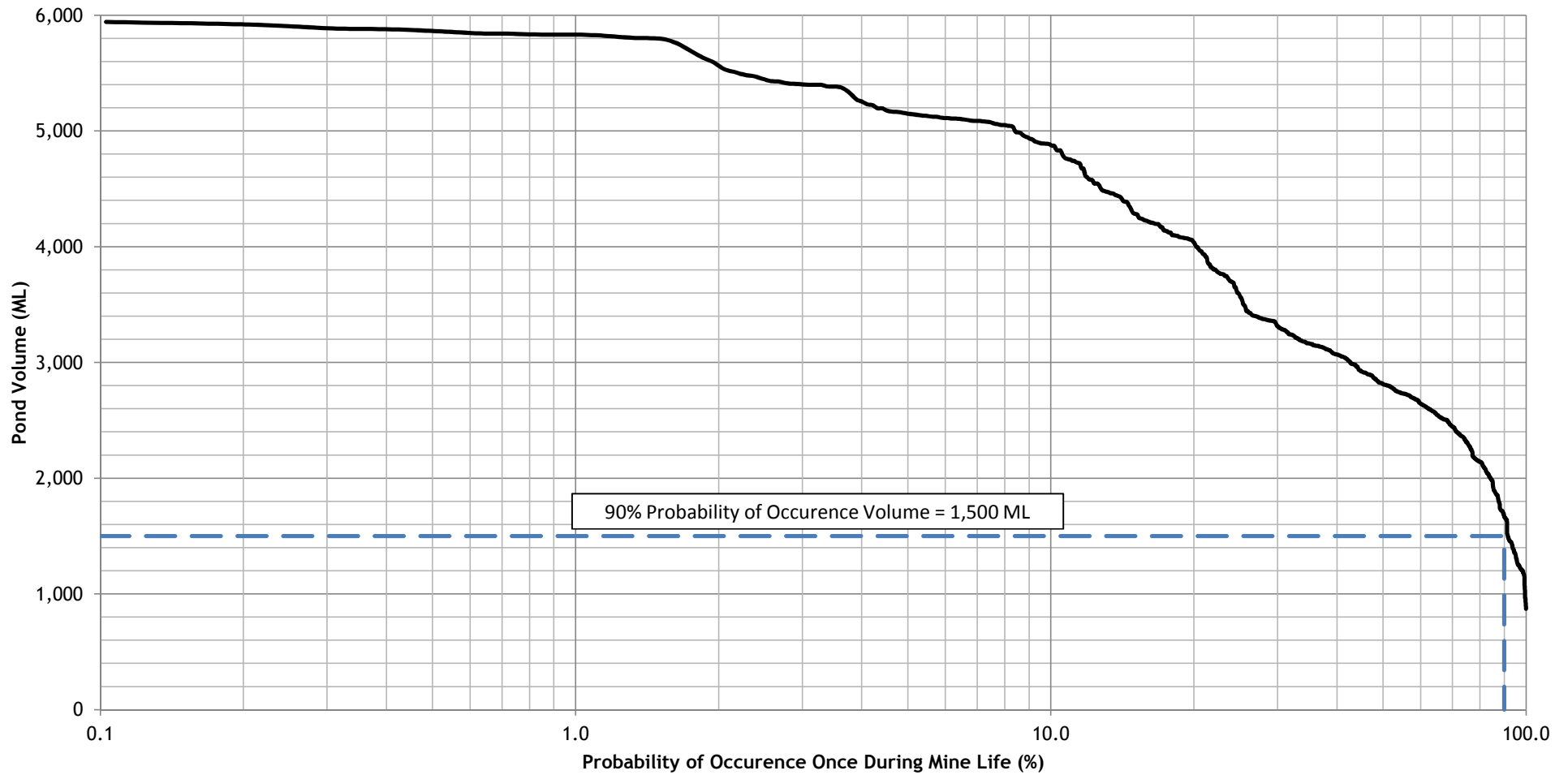
The reader's attention is also drawn to the "Conditions of Report" which appear on the title page of this report.

## REFERENCES

- [1] ATC Williams (December 2014), “MMG Dugald River - Tailings Storage Facility - Review of TSF Site and Design Options”, Ref: 108003.16-R01.
- [2] ATC Williams (September 2013), “MMG Dugald River - Tailings Storage Facility & Process Water Dam - Design Report”, Ref: 108003.07-R16.
- [3] ATC Williams (August 2013), “MMG Dugald River Tailings Storage Facility & Process Water Dam - Rainfall Analysis and Water Balance Report”, Ref: 108003.07-R15.
- [4] Department of Environment and Heritage Protection (November 2013, revised April 2014), “Manual for Assessing Consequence Categories and Hydraulic Performance of Structures”, EM635 Version 4.



### Maximum Volume on 1st November for Each Realisation - Probability Distribution



www.atcwilliams.com.au

#### MMG DUGALD RIVER

#### TAILINGS STORAGE FACILITY & PROCESS WATER STORAGE

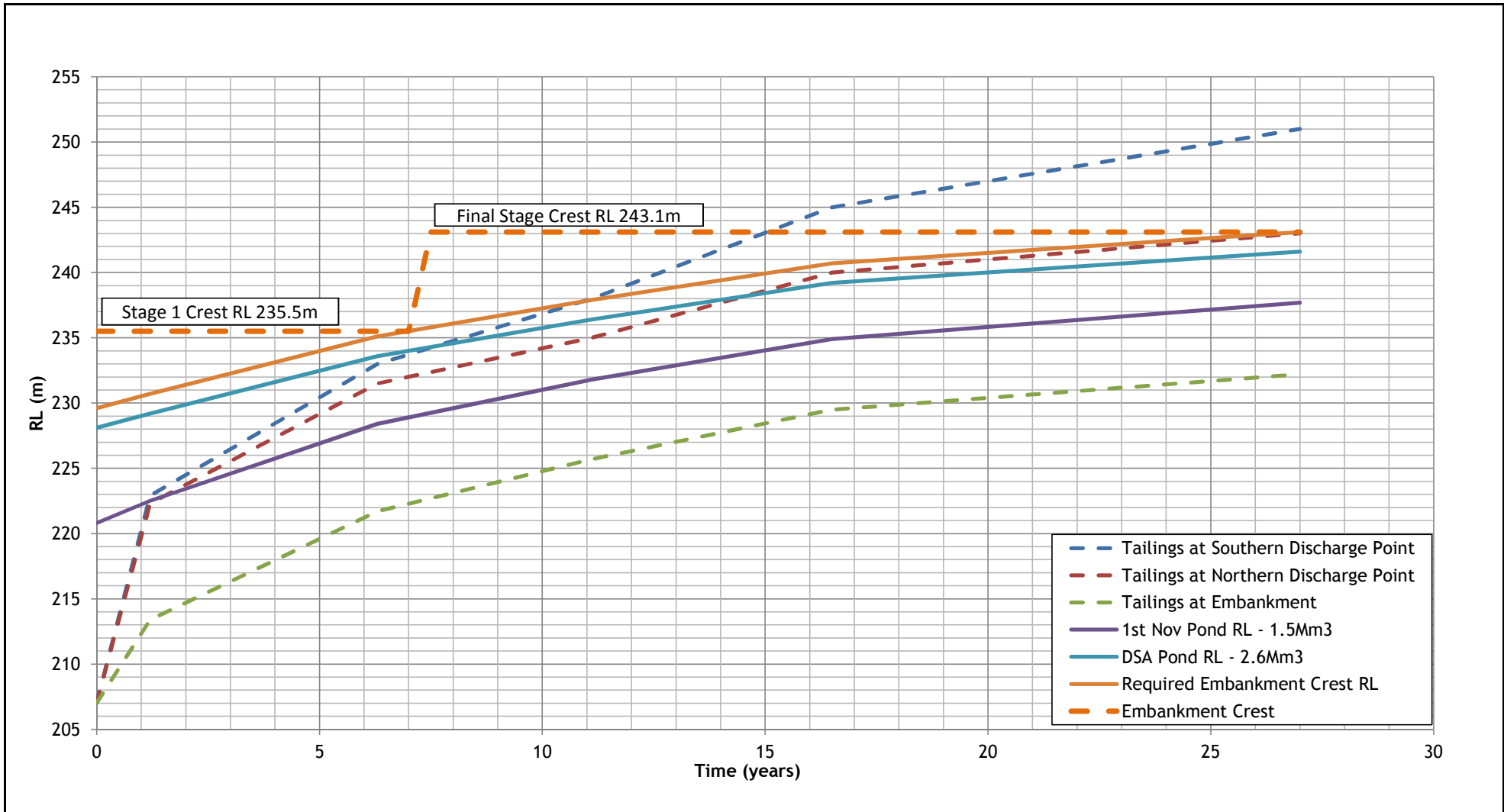
#### REVISED TSF CONCEPT DESIGN

#### Process Water Pond Maximum Volume on 1st November for Each Realisation

Date: 20/07/2015 Job No: 108003.20

**FIGURE 1**





ATC Williams Pty Ltd  
 222 Beach Road  
 (P.O. Box 5286)  
 Mordialloc Vic 3195  
 AUSTRALIA  
 T +61 3 8587 0900  
 F +61 3 8587 0901  
 melbourne@atcwilliams.com.au  
 www.atcwilliams.com.au

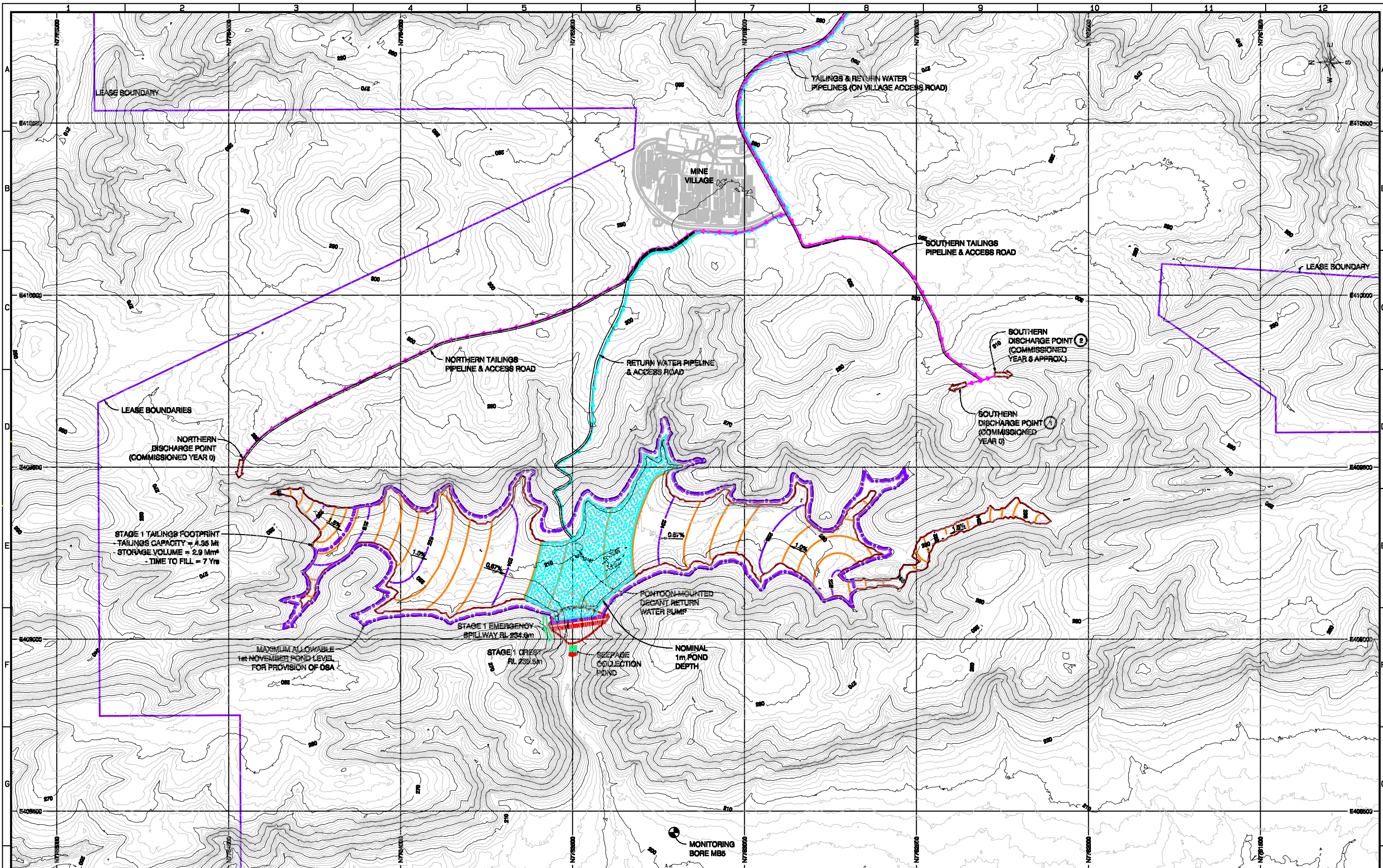
**MMG DUGALD RIVER**  
**TAILINGS STORAGE FACILITY & PROCESS WATER STORAGE**  
**REVISED TSF CONCEPT DESIGN**

**Tailings Deposition and Embankment Crest Staging**

Date: 20/07/2015 Job No: 108003.20

**FIGURE 2**





No.	DESCRIPTION	DATE	DRAWN	CHECKD	APPRD
1					
2					
3					
4					
5					

SCALE 1:10,000
JOB No. 106008.20
DATE 16.7.15
DESIGN CN
DRAWN DMR
CHECKED
APPROVED


**ATC Williams**  
 GROUNDED IN DESIGN

A.B.N. 64 006 931 288  
 www.atcwilliams.com.au  
 Melbourne +61 3 8587 0900  
 Brisbane +61 7 3362 7222  
 Perth +61 8 9355 8700

**MMG DUGALD RIVER**  
**TAILINGS STORAGE FACILITY & PROCESS WATER STORAGE**

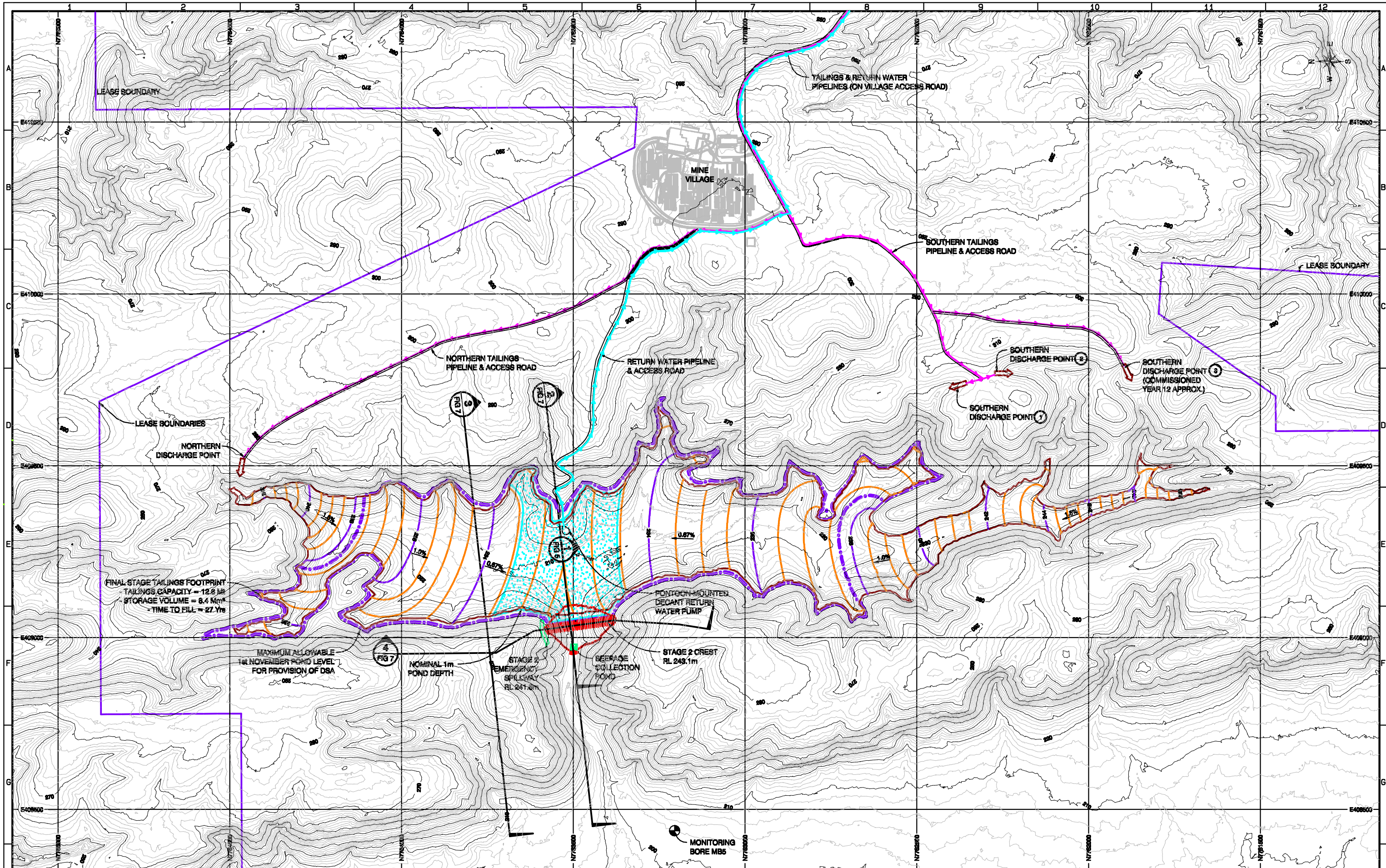
**REVISED TSF CONCEPT DESIGN**  
**STAGE 1 GENERAL LAYOUT - END OF FILLING (YEAR 7)**

**FIGURE 3**

CLIENT No. \_\_\_\_\_  
 CAD REF. \_\_\_\_\_

REV. 0    SHT SIZE A3  
 SHEET 1 OF 1





No.	DESCRIPTION	DATE	DRAWN	CHECKD	APPROD

SCALE	1:10,000
JOB No.	106008.20
DATE	16.7.15
DESIGN	CN
DRAWN	DMR
CHECKED	
APPROVED	


**ATC Williams**  
 GROUNDED IN DESIGN

A.B.N. 64 006 931 288  
 www.atcwilliams.com.au  
 Brisbane T +61 7 3362 7222  
 Perth T +61 8 9366 8700

**MMG DUGALD RIVER**  
**TAILINGS STORAGE FACILITY & PROCESS WATER STORAGE**

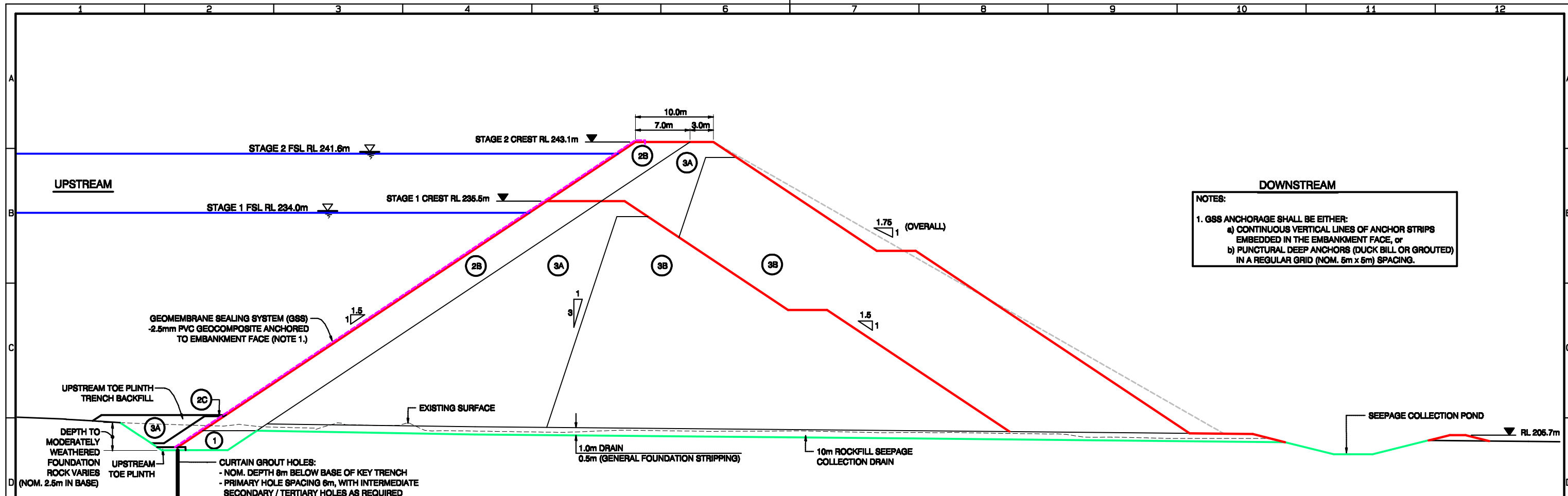
**REVISED TSF CONCEPT DESIGN**  
**STAGE 2 GENERAL LAYOUT - END OF FILLING (YEAR 27)**

**FIGURE 4**

CLIENT No. \_\_\_\_\_  
 QAD REF. \_\_\_\_\_

REV. 0    SHT SIZE A3  
 SHEET 1 OF 1





**NOTES:**  
 1. GSS ANCHORAGE SHALL BE EITHER:  
 a) CONTINUOUS VERTICAL LINES OF ANCHOR STRIPS EMBEDDED IN THE EMBANKMENT FACE, or  
 b) PUNCTURAL DEEP ANCHORS (DUCK BILL OR GROUTED) IN A REGULAR GRID (NOM. 5m x 5m) SPACING.

**SECTION 1**  
**MAIN EMBANKMENT (GSS OPTION)**  
 SCALE 1:500

SUMMARY OF EMBANKMENT ZONE MATERIALS & PLACEMENT REQUIREMENTS				
ZONE	NAME	MATERIAL/SOURCE	PLACEMENT	COMPACTION
1	Earthfill Core	CLAY, Clayey SAND, Clayey GRAVEL. Sourced from designated borrow area adjacent to Process Plant.	0.2m horizontal layers (compacted thickness) Moisture: (OMC - 2%) TO (OMC + 2%)	>= 95% Std Maximum Dry Density (Hilf Method)
2B	Drainage/ Support Layer	GRAVEL with Clay, Silt or Sand or Clayey Gravel. Maximum particle size 50mm, fines content 8% - 20% (produced on site)	0.4m horizontal layers (compacted thickness)	6 passes 10t vibrating smooth drum roller
2C	Granular Filter	Well-Graded SAND/GRAVEL mbc. Maximum particle size 25mm. Maximum fines content 8% by weight. Sourced from screened, processed granular material (produced on site)	0.4m horizontal layers (compacted thickness)	4 passes 10t vibrating smooth drum roller
3A	Transition Rockfill	Select quarried rockfill of weathering classifications Slightly Weathered to Fresh Max. particle size - 400mm (3A)	0.4m (loose thickness) horizontal layers	6 passes 10t vibrating smooth drum roller
3B	General Rockfill	- 800mm (3B)	0.8m (loose thickness) horizontal layers	6 passes 10t vibrating smooth drum roller

No.	DESCRIPTION	DATE	DRAWN	CHECKD	APPRD
1					
2					
3					
4					
5					

SCALE AS SHOWN

JOB No. 106003.20  
 DATE 16.7.15  
 DESIGN CN  
 DRAWN DMR  
 CHECKED  
 APPROVED

**ATC Williams**  
 GROUNDED IN DESIGN

A.B.N. 64 006 931 288  
 www.atcwilliams.com.au

Melb T +61 3 8587 0900  
 melbourne@atcwilliams.com.au

Bris T +61 7 3362 7222  
 brisbane@atcwilliams.com.au

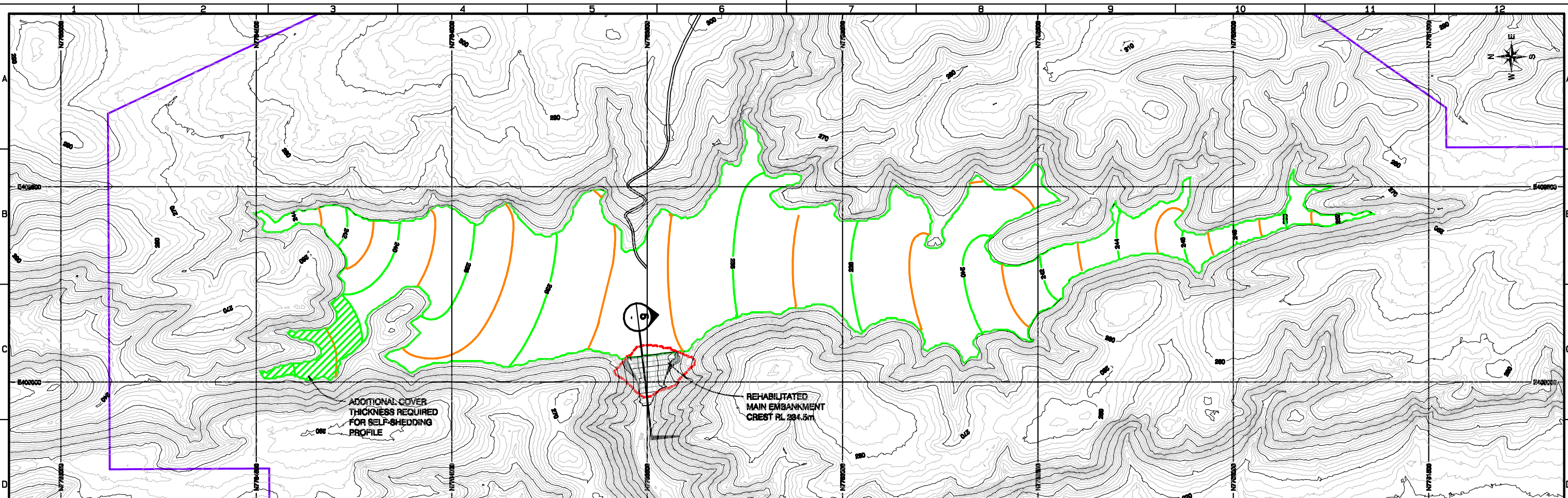
Perth T +61 8 9355 8700  
 perth@atcwilliams.com.au

**MMG DUGALD RIVER**  
**TAILINGS STORAGE FACILITY & PROCESS WATER STORAGE**

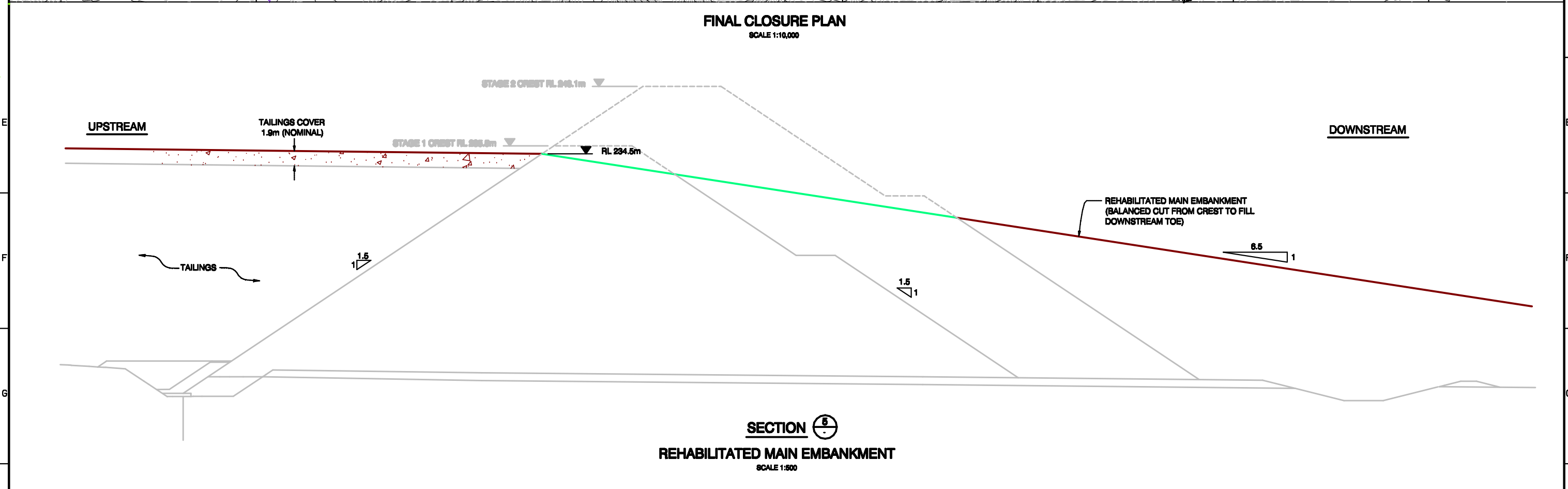
**FIGURE 5**

CLIENT No.  
 QAD REF.

REV. 0 SHIT SIZE A3  
 SHEET 1 OF 1



**FINAL CLOSURE PLAN**  
SCALE 1:10,000



**SECTION 6**  
**REHABILITATED MAIN EMBANKMENT**  
SCALE 1:500

No.	DESCRIPTION	DATE	DRAWN	CHECKD	APPROD
1					
2					
3					
4					
5					

SCALE AS SHOWN	
JOB No.	106008.20
DATE	16.7.15
DESIGN	CN
DRAWN	DMR
CHECKED	
APPROVED	

**ATC Williams**  
GROUNDED IN DESIGN

A.B.N. 64 006 931 288  
www.atcwilliams.com.au

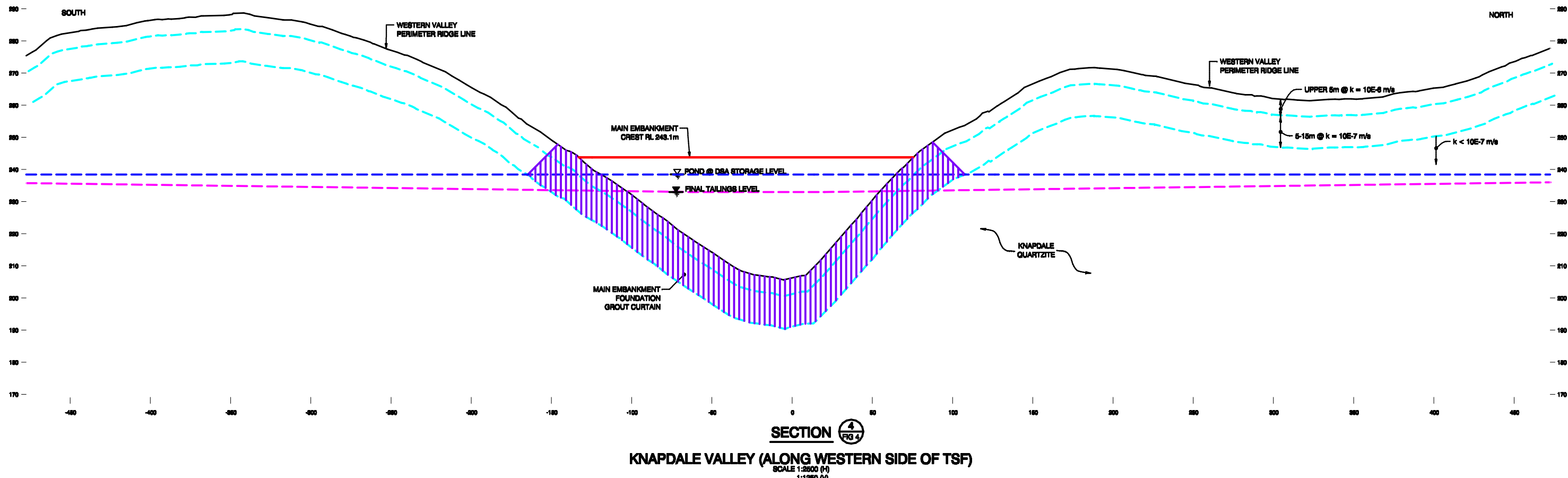
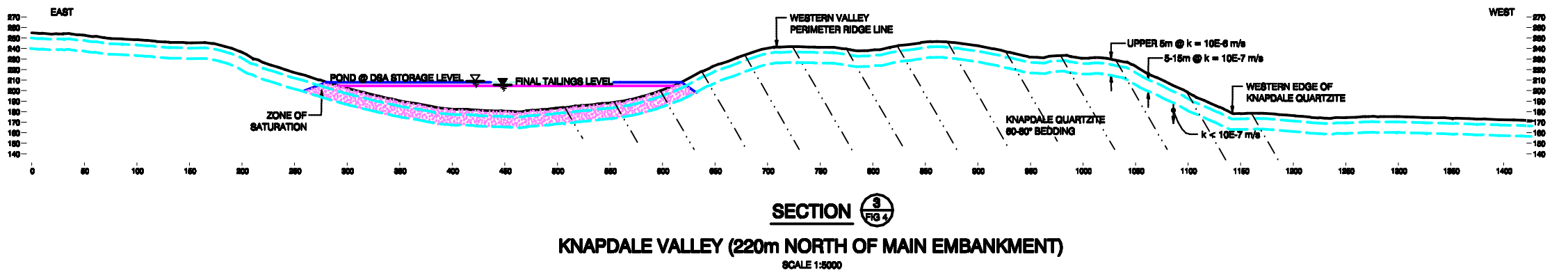
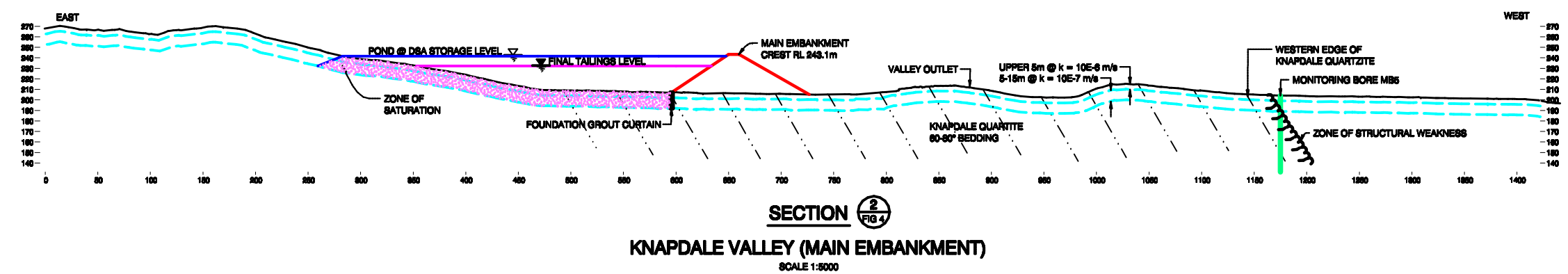
Melb T +61 3 8587 0900  
melbourne@atcwilliams.com.au

Bris T +61 7 3362 7222  
brisbane@atcwilliams.com.au

Perth T +61 8 9366 8700  
perth@atcwilliams.com.au

<b>MMG DUGALD RIVER TAILINGS STORAGE FACILITY &amp; PROCESS WATER STORAGE</b>		<b>FIGURE 6</b>
<b>REVISED TSF CONCEPT DESIGN CLOSURE CONCEPT</b>		
CLIENT No.		SHEET 1 OF 1
GAD REF.		
REV. 0	SHT SIZE A3	





No.	DESCRIPTION	DATE	DRAWN	CHECKED	APPROD
1					
2					
3					
4					
5					

SCALE AS SHOWN

JOB No.	106003.20
DATE	16.7.15
DESIGN	CN
DRAWN	DMR
CHECKED	
APPROVED	

**ATC Williams**  
GROUNDED IN DESIGN

A.B.N. 64 005 931 288  
www.atcwilliams.com.au

Melb T +61 3 8587 0900  
melbourne@atcwilliams.com.au

Bris T +61 7 3362 7222  
brisbane@atcwilliams.com.au

Perth T +61 8 9355 8700  
perth@atcwilliams.com.au

**MMG DUGALD RIVER**  
**TAILINGS STORAGE FACILITY & PROCESS WATER STORAGE**

**REVISED TSF CONCEPT DESIGN**  
**KNAPDALE VALLEY STRUCTURAL GEOLOGY & HYDROLOGY CROSS SECTIONS**

**FIGURE 7**

CLIENT No.	
QAD REF.	
REV. 0	SHT SIZE A3
SHEET 1 OF 1	

## Appendix C: Surface Subsidence Risk



# MEMORANDUM

**To** Jonathon Crosbie, Martin Brownlee

**Cc** Charles Smith, Adam Barton, Tim Akroyd

**From** Madeline Merrett

**Date** 19/05/2020

**Subject** **DRM SURFACE SUBSIDENCE RISK**

## MEMORANDUM SURFACE SUBSIDENCE GEOTECHNICAL RISK REVIEW

### BACKGROUND

As part of the DRM Progressive Closure and Rehabilitation Plan (PRCP), the surface and underground subsidence risk needs to be reviewed to ensure long term stability. As part of the Department of Environment and Science progressive rehab and closure guidelines a geotechnical study must be completed on surface subsidence risk and should include the following:

- Post closure stabilisation of underground workings (Geotechnical assessment of the stability of the underground openings, assessment of ground water conditions and ground water impacts on the design)
- Sealing off surface openings to underground workings (Geotechnical assessment of bulkhead materials, competency and stability of the ground containing the bulkhead, the need for additional ground support and reinforcement)
- Extent of post closure residual subsidence of underground workings (Geotechnical assessment of the stability of the underground openings and over burden, surface and ground water conditions and ground water impacts on subsidence)

### INTRODUCTION

The Dugald Rive Mine crown pillar and mine extraction method has been designed to ensure long term stability and prevent surface and underground subsidence. The primary purpose of the crown pillar is to protect surface land users, the mine, and all those who work within the mine. It is vital that the surface pillar remains stable throughout the life of the mine and remain stable beyond this time. Dugald River mine has adopted a sub level open stope mine method with backfill to increase the long-term stability of the mine and ensure consolidation of voids. The crown pillar has been designed to prevent surface subsidence and underground stope design guidelines are in place to prevent cave like failure underground.

All geotechnical risk on site at Dugald River Mine are captured in the ground control risk bowtie and the Ground Control Management Plan (GCMP). Previous work has been completed by consultants on the stability and design of the crown pillar and the influence of ground water on the stability of the mine which all form a part of the GCMP.

## WEATHERING

Weathering varies across the Dugald River deposit from gossan to a shallow weathering profile. The gossan marks the outcropping line of lode and extends along the crest of a low ridge for >2 km and at a width of up to 10 m. Weathering is a critical component of the rock mass characterisation and will have a significant impact on the overall crown pillar stability.

The DRM weathering and leaching depths are estimated in the following table:

Table 1: DRM Weathering Depths (AMC 2011)

	Hanging wall	Dugald Lode	Footwall
Base of complete Oxidation	12m	Variable	1m
Base of Leaching	31.5m	Variable	5m

Weathering to significantly greater depths is likely down sheared or faulted zones that intersect the surface particularly along the contact of the Dugald lode with the hangingwall and footwall slates.

The following assumptions have been made regarding the weathering profile for the crown pillar design (AMC 2011)

- Within the hangingwall, extremely to partially weathered rock can extend to depths of approximately 30m. Rock that is slightly weathered or weathered only on fractures, may extend to a depth in the order of 40m.
- Within the Dugald Lode and Footwall sequence, the weathering profile is shallow. In the absence of significant shears or fault zones, extremely to partially weathered rock may extend to depths of approximately 1m. Beyond 5m depth, weathering is only expected on fractures.

To ensure long term stability the crown pillar has been designed in fresh rock, below the level of significant weathering (Figure 1)

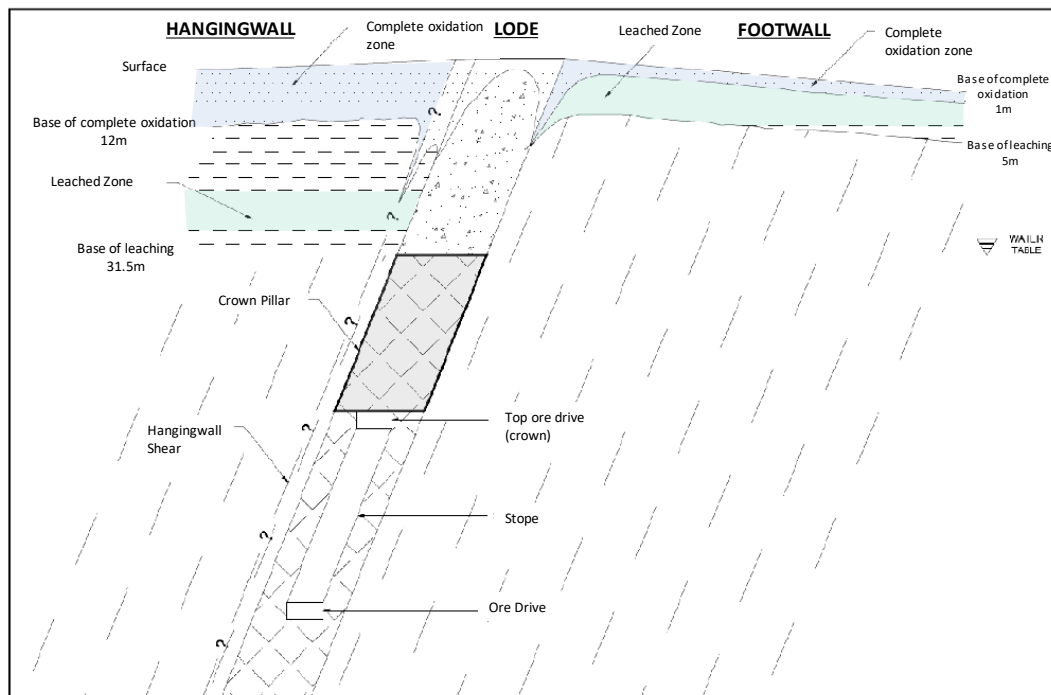


Figure 1 DRM Depth of Weathering

## GROUND WATER

The Dugald River hydrogeological conditions have been summarised in the document MMG Dugald River Mine Groundwater Monitoring Program (Big Dog Hydrogeology, September 2014) and in the Environmental Impact Statement (Rob Lait & Associates, 2010).

The following observations were outlined:

- Ground water depths, in bores around the project, range from 10.1m to 230m depth, with a median depth of 31.5m.

- Flows range from 0.13L/s to 9.3L/s, with a median value of 0.98L/s, with groundwater flows in excess of 2L/s being the exception
- The geological units around the Dugald River Project are not highly productive and the majority of the ground water occurs at shallow depths
- Very minor supplies of groundwater occur in the Dugald River Slates, which form the immediate hanging wall and footwall of the Dugald Lode.
- The gradient of the potentiometric surface is 0.009, which is typical of low bulk permeability.
- Ground water flow occurs predominantly in zones of fracturing close to the base of weathering in metasediments.
- Overall, the mining observations to date indicate low to moderate permeability for fracture zones within the Dugald River slate, with limited ground water storage.

Groundwater samples have been taken underground from STH-175 Level, STH Stock Pile \_1 and NTH Stock Pile 3. Generally, water flow into development at Dugald River Mine can be classified between wet and dripping.

Table 2 Ground Water Testing

Location	Electrical Conductivity (EC) $\mu\text{S/cm}$	TDS Mg/L ppm	pH	Temperature	Redox mV	Dissolved Oxygen % Sat
STH_175	1722	682	7.5	31.2	-108.7	10.4
STH_SP1	1545	612	6.06	30.5	-55.8	5.2
NTH_SP3	2055	814	7.34	30.2	-29.2	13.1

An assessment of the corrosivity of the ground water (MMG Internal File Note, December 2013) identified that the following:

- Groundwater intersected in development is associated with faults.
- Given the dissolved oxygen reading a corrosion rate of 0.12 (wet) to 0.20 mm/yr (dripping) can be expected.

### **CROWN PILLAR STABILITY (SURFACE SUBSIDENCE)**

AMC Consultants completed a study in March 2011 to investigate the geotechnical conditions of the crown surface pillar for the Dugald River Project (Dugald River Crown Pillar Assessment – AMC 111005 March 2011). As part of this study AMC assessed the weathering profile, depth of the water table and crown pillar stability and size.

Standard empirical assessment techniques based on ground conditions and Lode Geometry was used to determine the appropriate crown pillar size and thickness along the length of the orebody. Rock mass Quality Q (after Barton et al, 1974) was used to assess the rock mass and the scaled crown span concept and Critical span limits developed by Carter (1992) was used to assess the stability of the crown pillar.

It is assumed that any crown pillar instability at Dugald River mine will be the result of a significant geological feature such as faults or shears. The Dugald River rock mass data indicates that the overall rock mass quality of the Dugald Lode is better than the host slate material.

To ensure long term stability the crown pillar has been designed in fresh rock, below the level of significant weathering. The top-level stopes beneath the crown must also be backfilled, as tight as practically possible, to minimise the change of hangingwall unravelling in the long term.

Only shallow depths of ground water is expected to be encountered and ground water is only expected to occur above the base of weathering. The mine crown regional pillar has been designed beneath the base of weathering zone and hence this shallow ground water will not impact the stability of the crown and henceforth affect surface subsidence.

The results of the assessment indicate that the crown pillar is likely to be stable at the design strike of 25m between dip pillars for the widths proposed in the current mine design and the dimensions. (Figure 2 and Table 3)

Table 3: DRM Crown Pillar Size (AMC 2011)

Mining Area	Maximum Design Width	Minimum Crown Pillar Thickness in Unweathered Rock	Thickness of Weathered Rock	Minimum Distance to Surface (Ultimate Surface Crown Pillar)
North	3.4m	5.5m	31.5m	37m
South	9.8m	19m	31.5m	50.5m

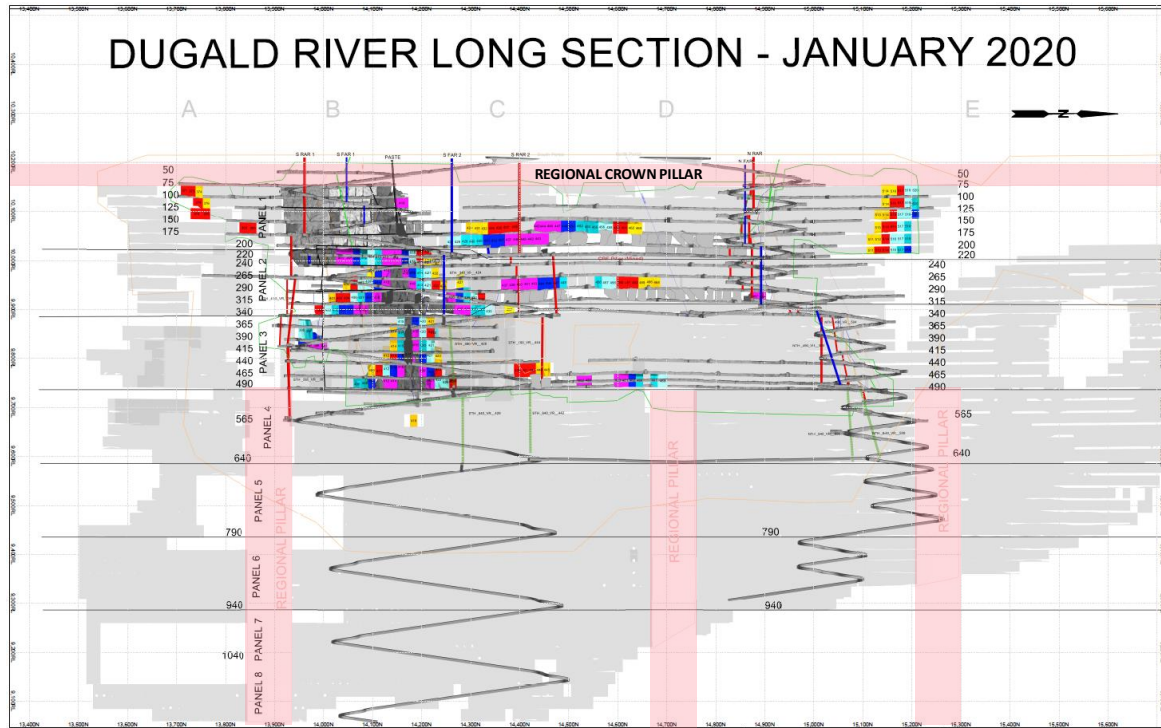


Figure 2 DRM Life of Mine Regional Pillar Locations

## UNDERGROUND OPENING STABILITY (UNDERGROUND SUBSIDENCE)

Dugald River mine extraction method is a Sub Level Open Stope operation with both Cemented and rockfill backfill methods.

All design requirements and stability assessment for underground excavations are covered in the GCMP Section 11 – Geotechnical Mine Design. The empirical modified Mathews Stability Graph (Mathews et al. 1981) is used to determine stable dimensions for open stopes. Stope span limited are determined using the geotechnical classification values developed from core logging, underground mapping and structural data available. All stopes underground are backfilled to eliminate the potential for subsidence underground. Backfill design methods are presented in the DRM Backfill Design Work Quality Requirement 15811530. A void register is in place to manage backfill type and potential voids underground in order to manage consolidation of voids underground.

All underground stope excavations have a short life span and are completely backfilled. All stopes are assessed based on local ground conditions experienced and there is minimal influence of ground water on stope stability long term.

The Modified Stability Graph Method has been used to determine the stability of the top stope back and hangingwall spans (AMC 2011). If any failure initiates in the top stope hangingwall material, it has potential to destabilise the stope backs, effectively increase the crown span and failure may occur. In order to prevent crown pillar failure throughout stoping the top stope back, maximum stope spans have been determined to prevent failure before backfilling. The stopes below the crown pillar spans are to be kept at 14m for black slate hangingwall and 22m for Dugald Lode hangingwall. These stopes must be tight filled.

The main cause of instability in the crown pillar is likely to be via collapse and progressive unravelling of the hangingwall and weathered material. This is prevented in the short term by using appropriate stope spans and cable bolts and in the long term by tight filling of the stope voids to provide confinement.

There is potential for ground water to permeate along fractured zones due to faulting and zones of weak rock mass. It has been recommended that rib pillars be left at all locations where E-W off-setting structures are identified. The rock mass in these fault zones are expected to have poorer rock mass which will enable ingress of water and increased weathering. The probability of unravelling, block, or chimney failure mechanisms will be higher in these localised areas.

## SEALING OFF SURFACE OPENINGS TO UNDERGROUND

There has been no design work completed on bulkhead design to seal off the underground mine for mine closure. At this stage due to the mine method and completely tight filling voids underground there is minimal risk of significant build-up of water in the underground workings and this assessment has not been deemed necessary.

## CURRENT SURFACE SUBSIDENCE CONTROLS IN PLACE

The following recommendations are for the exclusion zones and regional Crown pillars as per the GCMP:

- No extraction to occur above 10150RL (75 level) for both the South and North Mine. The crown pillar located above this RL is considered a primary pillar and cannot be mined for the Life of Mine (LOM).
- For stopes near the crown pillar, unravelling to be prevented by appropriate stope spans and cable bolts. Long-term stopes are required to be tight-filled to the floor of the drill drive as a minimum.
- No permanent civil infrastructure should be constructed over the crown pillar zones, or within 90m on the hanging wall side of the crown pillar.
- Commence regular surface subsidence monitoring by Permanent Survey Marks or other means during mining of the top stopes beneath the crown pillar. Focus on the Potentially Acid Forming (PAF) runoff dams and surface fault expression. Monitoring should continue for at least 6 months after tight filling is completed
- No water storage or settling ponds are to be located on the crown pillar zone, where water may infiltrate the ground surface and into the rock mass, owing to surface subsidence.
- crown pillar has been designed in fresh rock, below the level of significant weathering.
- All excavated voids underground are backfilled and managed in a void register

Crown pillar failure or uncontrolled failure underground can impact surface infrastructure, stockpiles, roads and dams. As an additional control the critical mill infrastructure is located to the east of all workings and the surface dams located to the west. In the event of an uncontrolled failure underground no critical infrastructure is likely to be affected. Figure 3 shows the location of the surface infrastructure with relation to the underground workings.

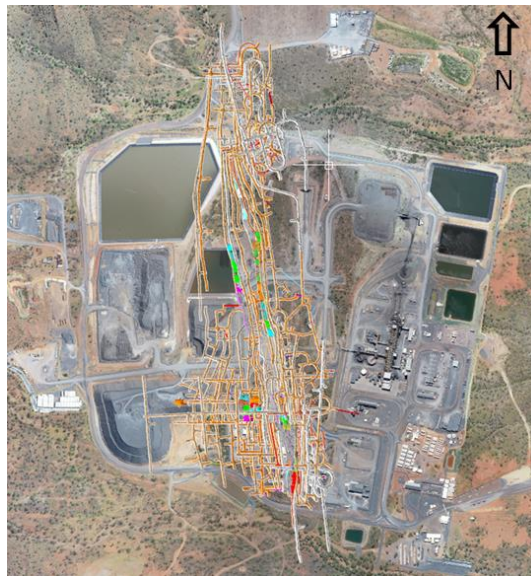


Figure 3 Plan view showing the surface of Dugald River mine with the as-built development and design stopes from Panel 1 and Panel 2

*NOTE: Panel 1 stopes closest to the surface are located to the east. The red coloured stopes are the crown stopes for panel 2 located 215m below surface.*

## CONCLUSION

From the geotechnical stability assessments completed based on weathering and ground water profiles and controls in place at Dugald river, post-mine closure underground stability and surface subsidence risk is low. Dugald river mine has a shallow weathering profile and shallow ground water therefore there is minimal influence of ground water on the underground stability and crown pillar stability.

All stopes extracted underground have limited stope strikes and are cable bolted to increase the short-term stability and are all backfilled with either waste rock or cemented backfill to ensure long term stability and confinement of voids to prevent long term subsidence.

## SUPPORTING REFERENCES

Barton, N; Lien, R; Lunde, J. 1974. "Analysis of Rock Mass Quality and Support Practice in Tunnelling and a Guide to Estimating Support Requirements" Report. No 54206

Big Dog Hydrogeology – MMG DRM Groundwater Monitoring Program 2014

Carter, T.G. 1992. "A New Approach to Surface Crown Pillar Design". Proc. 16<sup>th</sup> Can. Rock Mechanic Symposium, Sudbury. Pp 75-83.

Carter, T.G. 200. "An Update on the Scaled Span Concept for Dimensioning Surface Crown Pillars for New or Abandoned Mine Workings". Proc. 4<sup>th</sup> North American Rock Mechanics Conf. Seattle, pp. 465-472.

Carter, T.G, Alcott, J. and Castro, L.M. 2002. "Extending Applicability of the Crown Pillar Scaled Span Method to Shallow Dipping Stopes". Proc. 5<sup>th</sup> North American Rock Mechanics Conf, pp 1049-1059.

Dugald River Crown Pillar Assessment – AMC 111005 March 2011

Dugald River Mine Ground Control Management Plan - 8406637

DRM Backfill Design Work Quality Requirement 15811530

Mathews, K.E., Hoek, E., Wyllie, D., and Stewart, S.B., 1981. "Prediction of stable excavation spans for mining below 1000 metres in hard rock", Canada; CANMET, Dept. of Energy, Mines and Resources, DSS Serial No. OSQ80-00081, DSS File No. 17SQ.23440-0-9020

Potvin, Y., and Hadjigeorgiou, J., 2001. The Stability Graph Method for Open-stop Design. In: Hustrulid WA, Bullock RL, editors. Underground mining methods: engineering fundamentals and international case studies. Littleton, Colo: Soc Mining Metal Explor; 2001, P513-519

Rob Lait & Associates Pty Ptd, 2010. "Dugald River Mining Project, Environmental Impact Statement, Groundwater Aspects". RLA report 119, Australia.



## **Appendix D: Assessment of the Geochemical Characteristics and ARD Potential of Waste Rock for the Dugald River Zinc, Lead & Silver Deposit**



Prepared by:

**ENVIRONMENTAL GEOCHEMISTRY  
INTERNATIONAL PTY LTD**

ABN 12 003 793 486

81A College Street, Balmain, NSW Australia 2041

Telephone (61-2) 9810-8100 Facsimile (61-2) 9810 5542

Email [egi@geochemistry.com.au](mailto:egi@geochemistry.com.au)

For:

**Minerals and Metals Group**

Document No. 6412/934

**Dugald River Project Qld**

**Assessment of the Geochemical Characteristics and ARD Potential  
of Waste Rock for the Dugald River Zinc, Lead & Silver Deposit**

September 2010

## Contents

<b>1.0</b>	<b>Introduction.....</b>	<b>1</b>
<b>2.0</b>	<b>Previous Geochemistry Studies .....</b>	<b>3</b>
<b>3.0</b>	<b>Testing Program .....</b>	<b>5</b>
3.1	Sample Selection .....	5
3.2	Sample Preparation .....	6
3.3	Static Testing Program .....	6
3.4	Laboratory Procedures .....	7
<b>4.0</b>	<b>Acid Forming Potential of Dugald River Waste Rock.....</b>	<b>10</b>
4.1	Sulphur Content .....	10
4.2	Acid Neutralising Capacity.....	11
4.3	Net Acid Producing Potential.....	12
4.4	ARD Classification .....	13
<b>5.0</b>	<b>Reactivity of Carbonate Mineralisation within Dugald River Waste Rock .....</b>	<b>16</b>
<b>6.0</b>	<b>Sulphur Speciation and Reactivity within Dugald River Waste Rock .....</b>	<b>18</b>
6.1	Sulphur Speciation .....	18
6.2	Sulphur Reactivity .....	19
<b>7.0</b>	<b>Elemental Composition of Dugald River Waste Rock .....</b>	<b>22</b>
<b>8.0</b>	<b>Solute Leaching from Dugald River Waste Rock .....</b>	<b>25</b>
<b>9.0</b>	<b>Column Leach Testing of Dugald River Waste Rock .....</b>	<b>29</b>
<b>10.0</b>	<b>Summary and Implications for Dugald River Waste Rock Management .....</b>	<b>33</b>

**Table** (*after text*)

- 1: Acid forming characteristics of Dugald River waste rock - Samples arranged by drill hole
- 2: Acid forming characteristics of Dugald River waste rock - Samples arranged by lithology
- 3: Speciation of sulphur forms in Dugald River waste rock
- 4: Elemental composition of Dugald River waste rock
- 5: Geochemical abundance indices for Dugald River waste rock
- 6: Water extractable elements in Dugald River waste rock
- 7: Acid extractable elements in Dugald River waste rock
- 8: Peroxide extractable elements in Dugald River waste rock

**Figures** (*after text*)

- 1: Dugald River Project - Waste rock sampling program
- 2: Statistical summary of sulphur data for Dugald River waste rock
- 3: Statistical summary of ANC data for Dugald River waste rock
- 4: Statistical summary of NAPP data for Dugald River waste rock
- 5: Acid-base account plot for Dugald River waste rock
- 6: ARD classification plot for Dugald River waste rock
- 7: Acid buffer characteristics curve of Dugald River waste rock
  - (a) calc-silicate (#80448)
  - (b) mafic feldspar porphyry (#80424)
  - (c) lode waste (#80478)
  - (d) foot wall slate (#80430)
  - (e) foot wall limestone (#80436)
- 8: Sulphur speciation results for Dugald River waste rock
- 9: Kinetic NAG test profiles for Dugald River waste rock
  - (a) lode waste (#80454)
  - (b) lode waste (#80429)
  - (c) foot wall slate (#80443)
  - (d) hanging wall slate (#80483)
  - (e) foot wall slate (#80438)
- 10: Box plot showing the ratios of elemental concentrations in Dugald River waste rock relative to median soil composition

**Figures** (*continued*)

- 11: Statistical summary of extract assay data for water (w), acid (ac) and peroxide (ox) extractions tests on Dugald River waste rock
- 12: Plot of leachate pH for AARC column leach tests on Dugald River waste rock
- 13: Plot of sulphate concentrations in leachates from AARC column leach tests on Dugald River waste rock
- 14: Plot of calcium concentrations in leachates from AARC column leach tests on Dugald River waste rock
- 15: Statistical summary of AARC column leach assay data for samples comprising NAF Dugald River waste rock
- 16: Plot of Fe, Zn, Mn and Al concentrations in leachate from Column 3 containing a PAF waste mixture

**Appendices** (*after text*)

- A: Acid forming characteristics of drill core samples from previous geochemical studies of Dugald River waste rock
- B: Multi-element data and geochemical abundance indices for drill core samples from previous geochemical studies of Dugald River waste rock
  - B-1 Multi-element data
  - B-2 Geochemical abundance indices
- C: Results of column leach tests involving Dugald River waste rock
  - C-1 Acid forming characteristics of column leach samples
  - C-2 Leachate composition for HW slate (Column 1)
  - C-3 Leachate composition for FW limestone (Column 2)
  - C-4 Leachate composition for PAF rock mixture (Column 3)
  - C-5 Leachate composition for FW slate (Column 4)
  - C-6 Leachate composition for HW calc-silicate (Column 5)
  - C-7 Leachate composition for HW cal-silicate & mafic feldspar porphyry (Column 6)
  - C-8 Leachate composition for HW mica schist (Column 7)

## 1.0 Introduction

This report presents the results and findings of a geochemical assessment of drill core samples representing waste rock that will be produced at the Dugald River project located near Cloncurry in the north west region of Queensland. The study was commissioned by Minerals and Metals Group (MMG) as part of environmental studies being undertaken for the project.

The project will involve conventional underground mining of a stratabound, massive zinc/lead deposit hosted within a black slate environment and copper mineralisation in the adjacent hanging wall. The Dugald River deposit is estimated to contain 53 million tons of zinc/lead ore and 3.4 Mt of copper ore which will be mined over a 23 year mine life. Ore will be processed on site using conventional flotation technology, producing zinc, lead and copper concentrates for shipment and tailings that will be discharged to a tailings storage facility located to the west of the Knapdale Ranges. There will also be approximately 7 Mt of waste rock produced, mainly during the development of the decline.

Seven waste lithologies will be intercepted during mining of the Dugald River deposit. They are calc-silicate, white mica schist, mafic feldspar porphyry, hanging wall slate, mineralized lode waste, footwall slate, and footwall limestone. Calc-silicate, white mica schist and mafic feldspar porphyry will only be intercepted if mining of the copper ore is undertaken. The results of geochemical testing carried out by AARC (2008) indicated that most waste should be non-acid forming (NAF) but that some potentially acid forming (PAF) rock may be encountered, primarily as lode waste but also within the hanging wall and foot wall slate.

Sphalerite and galena are the main primary sulphides in Dugald River ore but pyrrhotite and pyrite also occur and are likely to be the main sulphide forms in mineralised waste rock. The presence of pyrrhotite and pyrite are a potential concern given that they will be subject to oxidation processes if the rock is exposed to atmospheric conditions. The potential for acidification of sulphidic rock will depend on both the sulphide content and the magnitude of any inherent neutralising capacity within the rock. Sulphidic rock that has little acid neutralising capacity (ANC) could be a potential source of *acid rock drainage* (ARD) and it is essential that such waste is identified and managed in a manner that limits the potential for sulphide oxidation and/or formation of acid conditions.

It is expected that drainage from non-acid forming rock should remain circum-neutral, nevertheless assessment of the potential to generate drainage with elevated salinity is necessary, as calcium and magnesium sulphates may be mobilised from non-acid forming rock by the combination of oxidation and neutralisation reactions. Such drainage, commonly referred to as *Neutral Mine Drainage* may also have measurable concentrations of trace elements (e.g. metals and metalloids) that are sparingly soluble at circum-neutral pH.

In recognition of the likelihood of some PAF waste rock and also the potential for generation of sulphate-rich neutral mine drainage, EGi was commissioned by MMG to review the findings of previous geochemical studies and to undertake further detailed assessment of the geochemical characteristics of samples representing waste rock that will be produced during the development of the Dugald River underground

mine. The main objectives of the geochemical testing program carried out on these samples were as follows:

- To determine the range of acid forming characteristics of the major waste rock units within the Dugald River deposit and to provide sufficient data for estimating the incidence of acid generating waste rock types within the proposed mine.
- To assess the forms and reactivity of the sulphide mineralisation within major waste rock units under controlled laboratory conditions, and to make preliminary estimates of the likely geochemical behaviour and lag times for acidification to occur under field conditions.
- To assess the reactivities of any carbonate mineralisation within major rock units that might delay or mitigate the generation of ARD.
- To identify any elemental enrichments within major rock units that might be environmentally significant and assess the potential for mobilisation of environmentally important elements which could impact on the quality of pit water and waste dump seepage.
- To assess the leaching potential of environmentally important elements from both PAF and NAF waste rock types and to assess the geochemical implications for mine water chemistry and the need for long term management of ARD from the waste dump and the final pit.

This report presents the results of the laboratory testing program carried out by EGi on drill core samples supplied by MMG and presents the main findings and implications of the current and previous geochemical investigations in relation to geochemical characteristics of waste rock and need for the selective handling and disposal of materials that could be problematic in respect of acid generations or metals leaching.

## 2.0 Previous Geochemistry Studies

There have been two previous geochemical studies of waste rock for the Dugald River project.

The first study was of a preliminary nature carried out by AGC Woodward-Clyde<sup>1</sup> as part of the pre-feasibility baseline environmental studies commissioned by Minenco Pty Limited in 1991. This study involved the assessment of the acid forming potential of 18 drill core samples representing waste rock and another five samples representing ore grade material within the Zn/Pb lode. The samples were taken from seven drill holes and the lithologies represented by the waste samples were hanging wall slate (6 samples), footwall slate (8) and limestone (4).

A second more detailed investigation of waste rock geochemistry was commissioned by OZ Minerals Australia Limited in 2008. This study was carried out by AARC<sup>2</sup> and included static geochemical analysis of 121 drill core samples and also establishment of a series of kinetic leach column tests. The samples were taken from 12 diamond drill holes and were representative of the following lithologies: calc-silicate (23 samples), mafic feldspar porphyry (3), white mica schist (13), hanging wall slate (38), lode waste (10), footwall slate (16) and foot wall limestone (18).

The acid forming characteristics of drill core samples assessed in the 1991 and 2008 studies are summarised in Appendix A. The testing programs for both studies involved measurements of existing pH, total sulphur content, acid neutralising capacity (ANC), and net acid producing potential (NAPP). The 2008 study also included measurement of net acid generation (NAG) capacity. Overall, a total of 139 samples representing waste rock were assessed for acid forming potential.

Multi-element assays were also carried out on all samples in the 1991 study and half the samples in the 2008 study. Samples in both the 1991 and 2008 studies were analysed for As, Cd, Co, Cu, Hg, Pb, S and Zn. The 1991 samples were also assayed for Bi and Sb, whilst the 2008 samples were also assayed for Ba, Be, Cr, Mn, Ni and V. The multi-element data for the previous studies are given in Appendix B.

The preliminary findings of previous geochemical investigations were as follows:

- The initial pHs of the majority of samples were circum-neutral, suggesting that drainage from freshly mined rock will likely be neutral to alkaline.
- Most samples were enriched to some extent with sulphur, but most samples also had high to very high ANCs and were classified as non-acid forming.

---

<sup>1</sup> AGC Woodward Clyde (1971). Preliminary Waste Characterisation. Report prepared for Minenco Pty Limited as part of the Dugald River Project - Prefeasibility Environmental Baseline Studies, July 1991.

<sup>2</sup> AustralAsian Resource Consultants (2008). Waste Rock Characterisation Report, Dugald River Project. Prepared for OZ Minerals Australia Limited, September 2008.



- Sulphur contents were distributed as follows:
  - 30% low (<0.01 to 0.3 %S)
  - 20% low to moderate (0.3 to 1.0 %S)
  - 50% high to very high (> 1%S)
- ANCs were distributed as follows:
  - 14% low (<10 kg H<sub>2</sub>SO<sub>4</sub>/t)
  - 28% low-moderate (10 to 50 kg H<sub>2</sub>SO<sub>4</sub>/t)
  - 58% high to very high (>50 kg H<sub>2</sub>SO<sub>4</sub>/t)
- Based on the NAPP and (when available) NAG test results, 95 samples (68%) were classified as non-acid forming and 40 samples (29%) were classified as potentially acid forming. The classifications of the other four samples were uncertain, but it is EGi's evaluation of the results that two of the four were more likely to be NAF and the other two more likely PAF.
- The main lithologies in which PAF samples occurred were lode waste (8 samples), hanging wall slate (22 samples), and pyritic foot wall slate (3 samples).
- In addition to elevated sulphur contents, many of the lode, hanging wall slate and footwall slate samples were significantly enriched to varying extents in one or more environmentally important elements that include arsenic, cadmium, copper, lead, mercury and zinc.
- Based on the results of the static testing program and the expected lithological distribution of waste rock at that time it was estimated by AARC (2008) that about one-quarter of total waste mined could be PAF. AARC(2008) recommended that, where possible, PAF waste should be prioritised for disposal to underground voids, whilst PAF waste rock remaining on the surface at closure would need to be fully encapsulated within NAF waste rock with high to very high ANC (e.g. limestone, calc-silicate and white mica schist).

## 3.0 Testing Program

### 3.1 Sample Selection

Seventy-two drill core samples were selected by MMG for the current geochemical program. Figure 1 shows the sample locations on a long-section through the proposed underground mining area.

When combined with samples from the two previous geochemical investigations carried out by AGC-Woodward Clyde (1991) and AARC (2008) there were 211 samples representing Dugald River waste rock. The samples were distributed between the seven lithologies as follows:

	AGC-WC (1991)	AARC (2008)	EGI (2010)	Combined
• Calc-silicate	0	23	8	31
• Mafic feldspar porphyry	0	3	4	7
• White mica schist	0	13	4	17
• Hanging wall slate	6	38	8	52
• Lode waste	0	10	8	18
• Footwall slate	8	16	20	44
• Footwall limestone	4	18	20	42

The guideline on *Assessment and Management of Acid Drainage* prepared by the Queensland Government, Department of Environment and Resource Management (DERM)<sup>3</sup> provides minimum numbers of samples that should be collected from each rock type based on the tonnage that will be mined. The tonnages of the various waste rock units generated by the Dugald River zinc/lead underground development will be 0.46 Mt of hanging wall slate, 0.66 Mt of lode waste, 2.88 Mt of footwall slate, and 3.11 Mt of footwall limestone. The corresponding minimum sample numbers for these tonnages based on interpolation of the DERM guideline are 18, 21, 43 and 45, respectively. Therefore, over the three geochemical assessment programs the numbers of samples tested were comparable to the DERM guideline.

<sup>3</sup> DERM (1995). *Assessment and Management of Acid Drainage*. Queensland Department of Environment and Resource Management, January 1995.

The guideline indicates the minimum number of samples collected from each rock/overburden type during initial sampling should generally be as follows; <0.01 Mt = minimum of 3, <0.1 Mt = minimum of 8, < 1 Mt = minimum of 26, and <10 Mt = minimum of 80. These discrete values can be interpolated using the formula  $y=25.9x^{0.48}$ , where y is the minimum number of samples and x is the tonnage (Mt) of the particular rock unit.

### 3.2 Sample Preparation

The samples for the current geochemical program were supplied as drill core pieces, with each sample typically weighing 1-2 kg. Following inspection of the samples they were forwarded to Sydney Environmental and Soil Laboratory Pty Ltd where sample preparation was carried out. Sample preparation included crushing to less than 4 mm size by conventional jaw crusher, then milling of a 200g split to less than 75 micron using a zirconia pulverising bowl. The crushed and pup samples were subsequently returned to EGI's laboratory for geochemical analysis.

### 3.3 Static Testing Program

The static testing program for the 72 drill core pulps included assessment of the same range of parameters as were determined in the 1991 and 2008 geochemical studies. They were:

- Existing pH and conductivity
- Total sulphur content
- Maximum potential acidity (MPA)
- Acid neutralising capacity (ANC)
- Net acid producing potential (NAPP)
- Net acid generation (NAG) capacity

The NAPP and NAG test results were reviewed then some samples were selected for more detailed analysis to either clarify the ARD classifications, assess sulphide or carbonate reactivity, and identify elemental enrichments and their potential leachability. The detailed testing of selected drill core samples included one or more of the following:

- Sulphur forms - 15 samples
- Sequential NAG test - 2 samples
- Kinetic NAG tests - 5 samples
- Acid buffer characteristic curves - 5 samples
- Solids multi-element analyses - 15 samples
- Water extractable elements - 15 samples
- Acid extractable elements - 15 samples
- Peroxide extractable elements - 15 samples

In addition to the static testing reported herein, MMG is currently assessing commissioning long-term column leach tests involving some waste rock samples discussed in this report.

### 3.4 Laboratory Procedures

#### *Existing pH and Conductivity*

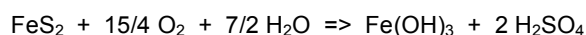
The pH and electrical conductivity of each sample were measured on a suspension comprising 30 g of crushed (minus 4 mm) sample in 60 mL of deionised water (*i.e.* 1:2 solid:water ratio), following at least 1 hour of equilibration.

#### *Total Sulphur Analyses*

The total sulphur content of each sample was determined by the Leco furnace method. Sulphur assays were carried out by Sydney Environmental & Soil Laboratory Pty Ltd under a quality assurance system certified as complying with ISO 9002.

#### *Maximum Potential Acidity*

The maximum potential acidity (MPA) is the amount of acid that theoretically could be generated by a sample if all the sulphur occurred as reactive pyrite and there was complete oxidation of the pyrite according to the following reaction:



The MPA of each sample, expressed as kg H<sub>2</sub>SO<sub>4</sub>/t, and was calculated from the %S content using a conversion factor of 30.6.

#### *Acid Neutralising Capacity*

The acid neutralising capacity (ANC) of each sample was determined using the Sobek Method. The method provides a direct measurement of the amount of acid that can be consumed by carbonate and other minerals within a rock sample, and involves reacting a sample with a known amount of acid at between pH 1 to 2 for approximately 1 to 2 hours. The residual acidity after reaction was back-titrated to determine the amount of acid consumed by the sample, expressed in terms of kg H<sub>2</sub>SO<sub>4</sub>/t.

#### *Net Acid Producing Potential*

The NAPP is the amount of acid that potentially can be produced by a sample after allowance for the ANC. It is calculated by subtracting the ANC value from the MPA value. If the NAPP is negative then it is likely that the material has sufficient inherent buffer capacity to prevent acid generation. Conversely, if the NAPP is positive then the material may be acid generating.

#### *Net Acid Generation*

NAG is a direct oxidation procedure for estimating the acid forming potential of a sample. The NAG test involved reaction of 2.5 g sample with 250 mL of 15% hydrogen peroxide to rapidly oxidise any sulphide minerals present. Both acid generation and acid neutralisation occur simultaneously during the NAG test,

hence the end result represents a direct measurement of the net amount of acid that a sample can generate. If the sample after reaction had a pH less than 4.5 (*i.e.* NAGpH<4.5) then it was considered to be acid forming and the actual amount of acidity generated was subsequently determined by titration of the mixture.

#### *Sequential NAG Tests*

With high sulphur samples the oxidation of sulphides is often not completed in a single stage NAG test, and a sequential multi-stage procedure is needed to ensure all sulphides are fully oxidised. In the sequential NAG test a 2.5 g sub-sample of tailings is reacted several times with 250 mL aliquots of 15% hydrogen peroxide. At the end of each stage, the sample is filtered to separate the solids and NAG liquor. The NAG liquor is assayed for pH and acidity, as per a standard NAG test. The solids are recovered and the oxidation process continued using another aliquot of hydrogen peroxide. The overall NAG capacity of the tailings is determined by summing the individual acid capacities from each stage.

#### *Kinetic NAG Tests*

Kinetic NAG tests were also carried out on selected tailings samples to assess the reactivity of the sulphides present and to provide an indication of the likely lag period for acid generation to occur under oxidising conditions. The kinetic NAG test is an accelerated oxidation procedure wherein a sample is reacted with hydrogen peroxide (as per the standard NAG test described in Section 2.2) and the reaction kinetics are continuously monitored by measuring the pH and temperature of the NAG solution.

#### *Acid Buffer Characteristic Curve*

An acid buffer characteristic curve was produced by slowly titrating of a sample with dilute HCl acid over a period of 16 to 24 hours. This titration method provides a far less aggressive treatment of a sample than that applied in the ANC method and hence provides a measure of the buffering provided by more soluble carbonates within a sample.

#### *Multi-Element Analysis of Solids*

The multi-element analysis of solids was carried out by Australian Laboratory Services (ALS) in Brisbane using NATA registered procedures. Mercury was assayed using an aqua regia digestion to ensure minimal volatilisation followed by analysis using inductively coupled plasma mass spectrometry. A suite of 34 other elements were assayed using a multi-acid digestion (*i.e.* hydrofluoric, nitric, perchloric and hydrochloric acids) followed by analysis using inductively coupled plasma optical spectrometry.

#### *Water Extractable Elements*

The water-soluble components within a sample were determined by extraction of 25 g of crushed (minus 4 mm) sample in 500 mL of deionised water (*i.e.* a solid:liquor ratio of 1:20) for 24 hours in accordance with the Australian Standard Leaching Procedure (ASLP). The extraction containers were agitated on an end-over-end shaker throughout the equilibration period, and at completion the pH and electrical conductivity of each

extract were recorded. The liquor fraction was then filtered through a 0.45 micron membrane filter, preserved with a few drops of high purity HNO<sub>3</sub> acid, then despatched to Australian Laboratory Services (ALS) in Sydney for multi-element analysis.

#### *Acid Extractable Elements*

The acid-soluble components within a sample were determined in accordance with the ASLP but using dilute sulphuric acid as the extractant. The extraction involved equilibration of 25 g of crushed (minus 4 mm) sample in 500 mL of 0.05 M H<sub>2</sub>SO<sub>4</sub> (*i.e.* a solid:liquor ratio of 1:20) for 24 hours with constant agitation. The pH and electrical conductivity of each extract were recorded, then the liquor fraction was filtered through a 0.45 micron membrane filter, preserved with a few drops of high purity HNO<sub>3</sub> acid, then despatched to Australian Laboratory Services (ALS) in Sydney for multi-element analysis.

#### *Peroxide Extractable Elements*

Elements that may be mobilised as a consequence of sulphide oxidation were determined by reacting 2.5 g of sample with 250 mL of 15% hydrogen peroxide, as per the NAG test procedure described above. Following reaction of the sample the NAG liquor was re-adjusted to 250 mL with deionised water, then a sub-sample was filtered through a 0.45 micron membrane filter, preserved with a few drops of high purity HNO<sub>3</sub> acid, then despatched to Australian Laboratory Services (ALS) in Sydney for multi-element analysis. A second sub-sample was titrated as per the normal NAG procedure to determine the amount of any acidity generated during the test.



## 4.0 Acid Forming Potential of Dugald River Waste Rock

The acid forming characteristics of the 72 drill core samples assessed by EGi are summarised in Table 1 with the samples sorted according to the drill hole number. The same data are also presented in Table 2 with the samples sorted according to lithology and ARD classification.

As the procedures used to assess these samples were the same as those used in previous geochemical investigations by AGC-Woodward Clyde (1991) and AARC (2008), the three datasets were combined to allow a more comprehensive review. This provided an overall total of 211 samples representing waste rock that were distributed between the seven lithologies as follows:

	Sample Count	Percent of Total
• Calc-silicate	31	~ 15%
• Mafic feldspar porphyry	7	~ 3%
• White mica schist	17	~ 8%
• Hanging wall slate	52	~ 25%
• Lode waste	18	~ 9%
• Footwall slate	44	~ 21%
• Footwall limestone	44	~ 20%

### 4.1 Sulphur Content

The sulphur content distributions for each of the seven lithologies are shown graphically in Figure 2. The sulphur content range and median content for each lithology were as follows:

	%S Median	%S Range
• Calc-silicate	<0.01	<0.01 - 1.57
• Mafic feldspar porphyry	<0.01	<0.01 - 0.77
• White mica schist	0.03	<0.01 - 0.29
• Hanging wall slate	1.8	<0.01 - 14.4
• Lode waste	6.4	1.2 - 16.6
• Footwall slate	1.1	0.45 - 14.6
• Footwall limestone	1.0	0.1 - 2.12

The sulphur contents of samples representing calc-silicate, mafic feldspar porphyry and white mica schist were generally low, with 87% of the samples from these three lithologies containing less than 0.1 %S, and only a few samples exceeding 0.3 %S.

In contrast, the sulphur contents of samples representing lode waste, hanging wall and footwall slate, and footwall limestone were typically in the moderate to high range. Not surprisingly, sulphur enrichment is particularly high in lode waste. The median sulphur content for lode waste samples was 6.4 %S. Furthermore, one-third of the lode samples had sulphur contents exceeding 10 %S.

On average, the extent of sulphur enrichment in hanging wall and footwall slate was less than for lode waste but nevertheless still significant. The median sulphur contents for the two slate lithologies were 4.1 and 1.8 %S, respectively and approximately one-third of the slate samples had sulphur contents exceeding 2 %S.

Almost all of the footwall limestone samples were also enriched but concentrations were typically confined to between 0.5 to 1.5 %S. The median sulphur content for limestone samples was 1.0 %S.

## 4.2 Acid Neutralising Capacity

The ANC distributions for each of the seven lithologies are shown graphically in Figure 3. The median, range and percentage of samples with ANCs in the high to very high range (*i.e.* ANC exceeding 100 kg H<sub>2</sub>SO<sub>4</sub>/t) were as follows:

	Median (kg H <sub>2</sub> SO <sub>4</sub> /t)	Range (kg H <sub>2</sub> SO <sub>4</sub> /t)	Percent with ANC>100 kg H <sub>2</sub> SO <sub>4</sub> /t
• Calc-silicate	169	9 - 688	81 %
• Mafic feldspar porphyry	79	21 - 401	43 %
• White mica schist	32	9 - 252	24 %
• Hanging wall slate	31	5 - 455	27 %
• Lode waste	13	5 - 398	28 %
• Footwall slate	108	11 - 548	55 %
• Footwall limestone	235	10 - 552	90 %

The results indicate wide ranging ANC values for all lithologies. As might be expected, the majority of footwall limestone samples had high to very high ANCs, as did most of the calc-silicate samples and more than half of the footwall slate samples.

The neutralising capacities of the hanging wall slate and the white mica schist samples were, on average, noticeably lower with median ANCs for the two lithologies of 31 and 32 kg H<sub>2</sub>SO<sub>4</sub>/t, respectively. Nevertheless around one-quarter of the samples from each lithology had ANCs exceeding 100 kg H<sub>2</sub>SO<sub>4</sub>/t.

The ANCs of lode waste samples were bi-modal in distribution. Thirteen of the 18 lode waste samples had low ANCs in the range 5 to 34 kg H<sub>2</sub>SO<sub>4</sub>/t. The other five lode waste samples had very high ANCs between 208 and 398 kg H<sub>2</sub>SO<sub>4</sub>/t.

### 4.3 Net Acid Producing Potential

The calculation of NAPP represents the balance between a samples acid potential and neutralisation capacity. This balance is sometimes also referred to as an acid-base account. The acid potential is related to the presence of sulphides, and in this study was indirectly determined from the total sulphur content, assuming that all sulphur occurred as pyrite. This is a conservative assumption, hence the acid potential can be regarded as the maximum potential acidity (MPA) that could be produced by a sample.

The NAPP represents the net acidity after allowance for the neutralising capacity within a sample, as determined directly using the standard Sobek method (as discussed Section 3.4). The difference between the two components represents the net acid producing potential or NAPP, which. The NAPP is expressed in terms of weight of acid generation per unit weight of rock (kg H<sub>2</sub>SO<sub>4</sub>/t) and may be positive or negative depending on the relative magnitudes of the respective acid and neutralising potentials.

The NAPP distributions for each of the seven lithologies are shown graphically in Figure 4. The median, range and percentage of samples with positive NAPPs were as follows:

	Median (kg H <sub>2</sub> SO <sub>4</sub> /t)	Range (kg H <sub>2</sub> SO <sub>4</sub> /t)	Percent with +ve NAPP
• Calc-silicate	-161	-688 to -9	0 %
• Mafic feldspar porphyry	-72	-401 to -21	0 %
• White mica schist	-31	-246 to 0	0 %
• Hanging wall slate	10	-423 to 421	58 %
• Lode waste	104	-187 to 500	78 %
• Footwall slate	-71	-512 to 390	20 %
• Footwall limestone	-195	-513 to 18	2 %

The results indicate that with samples representing calc-silicate, mafic feldspar porphyry, white mica schist and footwall limestone the neutralising capacity exceeds the acid potential of contained sulphides, in many cases by a large amount (*i.e.* samples were strongly NAPP negative).

The NAPPs of samples representing lode waste and hanging wall and footwall slate varies widely from strongly negative through to strongly positive. The majority of footwall slate samples were NAPP negative, lode waste samples were predominantly NAPP positive, whilst hanging wall slate samples relatively evenly divided.

Figure 5 shows an acid-base account plot for the combined data set. The acid-base account plot illustrates the relationship between the sulphur content (and hence MPA) of a sample and its ANC. This type of plot not only provides an indication of the acid forming potential of a sample but also illustrates the relative balance between the two parameters.

#### 4.4 ARD Classification

The ARD classifications of the 18 waste rock samples previously tested by AGC-Woodward Clyde (1991) were based solely on NAPP values. For all other samples, the ARD classifications were assigned on the basis of both the NAPP value (as discussed above) and the sample's net acid generation (NAG) capacity. The latter was determined directly by reaction of the sample with hydrogen peroxide. A sample is considered to have a positive NAG capacity if it acidifies to pH 4.5 or less, in which case the amount of acid generated<sup>4</sup> is determined by titration. Because the NAPP and NAG values are determined independently of each other, the combination of the NAPP and NAG results provides greater certainty to the classification.

The ARD classification criteria were as follows:

- **Non-Acid Forming (NAF)** - A sample was considered to be NAF if it had a negative NAPP and the sample did not acidify to any significant extent when oxidised with peroxide in the NAG test (*i.e.* NAG=0 or NAGpH $\geq$ 4.5). Although sulphides may be present in such samples, the inherent ANC is generally sufficient to neutralise any acid that might have been produced by sulphide oxidation.
- **Potentially Acid Forming (PAF)** - A sample was considered to be PAF if the NAPP and NAG were both positive. The exposure of such rock to atmospheric conditions is likely to result in sulphide oxidation, which in turn could result in tailings acidification.
- **Uncertain (UC)** - With some samples there was a disparity between the NAPP and NAG test results, and in such cases an *uncertain* (UC) classification was assigned. A disparity may occur if the NAPP is negative but the sample acidifies to less than pH 4.5 in the NAG test, or when the NAPP is positive but it does not acidify under NAG test conditions. The former may occur when the ANC within a sample is not readily available, and the latter may occur when some sulphur occurs as sulphate or as sulphides that do not generate acid when oxidised. The ARD classification considered most likely was indicated in brackets *e.g.* UC(NAF) or UC(PAF).

Figure 6 shows an ARD classification plot for the combined dataset, excluding the 18 samples from the AGC-Woodward Clyde (1991) study which did not include NAG testing. The ARD classification plot illustrates the concurrence of the NAPP and NAG test results. Clearly, the majority of samples plot either in the upper left quadrante (*i.e.* negative NAPP and NAGpH $\geq$ 4.5) signifying samples were NAF, or in the lower right quadrante (positive NAPP and NAGpH $<$ 4.5) signifying samples were PAF. There were only five samples (four from the AARC study and one sample in the current EGi study) that could not be definitively classified due to conflicting NAPP and NAG test results. Tentative classifications were assigned as follows:

- |               |  |   |
|---------------|--|---|
| • AARC (2008) | White mica schist (DR342, 272.5-273m)  | likely PAF ( <i>but low capacity only</i> ) |
| • AARC (2008) | Hanging wall slate (DR346, 410-410.5m) | likely NAF                                  |
| • AARC (2008) | Hanging wall slate (DR315, 84.5-85m)   | likely PAF                                  |
| • AARC (2008) | Footwall slate (DR342, 424-425m)       | likely PAF                                  |
| • EGi (2010)  | Lode waste (DR379 631-631.5m)          | likely NAF ( <i>based on seq NAG test</i> ) |

<sup>4</sup> Note: A sample may have a positive, zero or negative NAPP, but the NAG value can only be positive if acidification (*i.e.* NAGpH $\leq$ 4.5) occurs, or zero if there is no acidification in the NAG test.

The last three samples on this list typically had high sulphur contents, high ANCs and strong positive NAPPs but they did not acidify when oxidised with peroxide in the NAG test. With the two AARC (2008) samples it is possible that the absence of acidification in the single-stage NAG tests was associated incomplete sulphide oxidation, which is a common occurrence with samples where the sulphur content and ANC are both high. As this possibility could not be confirmed, both samples were conservatively classified as PAF based on the positive NAPP results.

In the case of the one *uncertain* sample in the current study a follow-up sequential NAG test was carried out by EGi to verify the classification. Ten sequential stages of oxidation were carried to ensure complete sulphide oxidation. In all stages the pH of the NAG liquor remained circum-neutral. Therefore, although the classification remains uncertain, the results of the sequential NAG test suggest that the sample was more likely to be NAF.

After allowing for these tentative classifications, the NAF/PAF distributions for each of the seven lithologies were as follows:

	Total	PAF	NAF
• Calc-silicate	31	0 (0 %)	31 (100 %)
• Mafic feldspar porphyry	7	0 (0 %)	7 (100 %)
• White mica schist	17	2 (12 %)	14 (88 %)
• Hanging wall slate	52	28 (54 %)	24 (46 %)
• Lode waste	18	13 (72 %)	5 (28 %)
• Footwall slate	44	9 (20 %)	35 (80 %)
• Footwall limestone	42	1 (2 %)	41 (98 %)

The main points to note in relation to acid forming characteristics are as follows:

- Calc-silicate*
- negligible sulphur and high to very high ANC
  - virtually all likely to be NAF and most will have a large excess of neutralising capacity due to high carbonate content.
- Mafic feldspar porphyry*
- low sulphur and moderate to high ANC
  - a relatively small number of samples tested but results suggest waste rock from this lithology will be NAF, most with a considerable excess of neutralising capacity.
- White mica schist*
- low sulphur and variable ANC (from low to high)
  - results suggest waste rock from this lithology will predominantly be devoid of sulphur and hence will be NAF, but there is a possibility of some material with low ANC (<10 kg H<sub>2</sub>SO<sub>4</sub>/t) which has slightly elevated sulphur (~0.3 %S) that could be PAF, albeit with a low capacity for acid generation.

- Hanging wall slate*
- moderate to high sulphur content and variable ANC
  - results indicate a major portion of waste rock from this lithology will be PAF, some with a very high capacity for acid generation. There will also be some NAF rock, which is primarily distinguished by having high to very high ANC.
- Lode waste*
- high to very sulphur content and variable ANC
  - majority of mineralised waste within the lode will be PAF with a very high capacity for acid generation. Only lode waste with very high ANC (*i.e.* >200 kg H<sub>2</sub>SO<sub>4</sub>/t) will be NAF.
- Footwall slate*
- moderate to high sulphur content and moderate to high ANC
  - results suggest that footwall slate will be predominantly NAF but some footwall slate with low ANC is likely to be PAF.
- Footwall limestone*
- moderate sulphur content and moderate to high ANC
  - results suggest virtually all footwall limestone is likely to be NAF and will have a large excess of neutralising capacity.



## 5.0 Reactivity of Carbonate Mineralisation within Dugald River Waste Rock

Many of drill core samples tested had high acid neutralising capacities. This was particularly the case for samples representing calc-silicate and footwall limestone, but also included samples from each other lithologies. Overall, approximately 54% of samples had ANCs greater than 100 kg H<sub>2</sub>SO<sub>4</sub>/t, and around half of these had ANCs exceeding 200 kg H<sub>2</sub>SO<sub>4</sub>/t.

In this study and the previous geochemical studies of Dugald River waste rock the ANCs of drill core samples were determined using the Sobek method. As described in Section 3.4, the Sobek method involves measurement of acid consumption by a sample under relatively strong acid conditions, typically around pH 1 to 2. The method therefore represents an aggressive treatment of the sample and accounts for buffer capacity provided not only by the more readily-available carbonate minerals such as calcite and dolomite but also less reactive forms such as ferroan dolomite, siderite, and some clay minerals.

The following five samples were selected for further testing to define the reactivity of the mineralisation responsible for the ANC under circum-neutral and weak acid conditions:

MMG / EGi Codes	Lithology	Sulphur (%S)	ANC (kg H <sub>2</sub> SO <sub>4</sub> /t)
80448 / 40886	Calc-silicate	1.57	210
80424 / 40862	Mafic feldspar porphyry	0.77	79
80478 / 40916	Lode waste	2.38	219
80430 / 40868	Footwall slate	1.15	120
80436 / 40874	Footwall limestone	1.06	462

Each sample was slowly titrated with dilute H<sub>2</sub>SO<sub>4</sub> over a period of about 18 to 24 hours to produce an acid buffer characteristic curve (ABCC). The slow acid addition represents a milder treatment of a sample than that applied in the standard Sobek method. One advantage of the buffer curve is that it can be used to identify if there is any carbonate mineralisation that can buffer the sample at around neutral pH, which is usually required to produce a substantial lag phase and which is essential for maintaining low metal solubilities.

The buffer curves for the five samples are given in Figures 7(a) to 7(e), respectively. All five samples produced well defined plateaus indicating strong pH buffering at near neutral pH, and confirming the presence of readily available carbonates<sup>5</sup> as the dominant source of the high ANC. In each case, the starting

<sup>5</sup> As a general rule, calcite and limestone are typically readily available for neutralisation and can maintain pH-neutral conditions up until almost all the ANC is consumed. Dolomite is also usually reactive, however the reactivity may decline when there is significant iron substitution, such as with ferroan dolomite. In contrast, magnesite and siderite are usually poorly reactive at circum-neutral pH, and significant dissolution of these carbonates often only occurs under laboratory conditions when the pH drops below about 4. Furthermore, iron carbonate (siderite) does not

pH was greater than pH 8, indicating that fresh rock similar to the test samples should be a potential source of alkaline drainage.

The readily-available buffer capacity was quantified as the amount of acid required to lower the pH of a unit weight of sample to 4.5, which generally marks the end of the buffer plateau and is the pH used in the NAG test to differentiate NAF and PAF materials. The readily-available buffer capacities were as follows:

MMG / EGi Codes	Lithology	Start pH	ANC (kg H <sub>2</sub> SO <sub>4</sub> /t)	Readily Available (kg H <sub>2</sub> SO <sub>4</sub> /t)	% Readily Available
80448 / 40886	Calc-silicate	8.6	210	208	99%
80424 / 40862	Mafic feldspar porphyry	8.4	79	100	100%
80478 / 40916	Lode waste	9.4	219	210	96%
80430 / 40868	Footwall slate	9.5	120	116	97%
80436 / 40874	Footwall limestone	9.4	462	475	100%

This comparison confirms that virtually all of the ANCs of the five samples resulted from carbonate forms that were readily-available under circum-neutral to weak acidic conditions. Such forms could be expected to provide effective buffering of sulphide derived acidity if such material were exposed to atmospheric conditions.

---

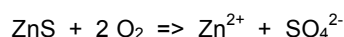
contribute to the ANC of a sample. This is because the dissolution of FeCO<sub>3</sub> during the acidification stage of the ANC method is negated by the re-precipitation of iron hydroxide during the back-titration step of the method.

---

## 6.0 Sulphur Speciation and Reactivity within Dugald River Waste Rock

### 6.1 Sulphur Speciation

In this study the calculation of NAPP was based on total sulphur assays, assuming that the sulphur occurs as pyrite. This represents a conservative approach in that some sulphur can occur as sulphate, which is non-acid generating, and/or as other metal-sulphides that generate less acidity than pyrite when oxidised. For example, monosulphides such as sphalerite (ZnS) and galena (PbS) typically do not contribute significantly to the acid forming potential as both sulphides generate little or no free acid when oxidised. The oxidation of sphalerite by oxygen occurs without generating hydrogen ions according to the reaction:



Consequently, sphalerite and galena (which would be expected to occur mainly within mineralised lode waste) are generally not regarded as acid generating, although the oxidation of these sulphide minerals does release zinc and lead, respectively.

A preliminary assessment of sulphur forms within Dugald River waste rock was carried out based on selective extraction methods. Fifteen samples with elevated sulphur contents were selected by EGi and analysed by ALS (Brisbane) for the following:

- Total sulphur - Measured using a Leco sulphur analyser.
- Sulphate-sulphur - Sample leached with hot HCl to remove acid-soluble sulphates. The amount of sulphate within the leachate is then determined by ICPAES. The acid leachable fraction is generally considered to be sulphate, although the method isn't always specific as some mono-sulphides can dissolve to varying extents.
- Sulphide-sulphur - Calculated as the difference between Total-S and Sulphate-S values.
- Cr Reducible S - Sample reacted with hot acidic CrCl<sub>2</sub> to reduce (non-sulphate) inorganic sulphur forms to H<sub>2</sub>S which are trapped in zinc acetate solution for assay. Chromium reducible sulphur is generally deemed to occur specifically as pyritic-S forms but may include some elemental-S if present in a sample.

The sulphur speciation results are given in Table 3 and shown graphically in Figure 8. The samples included:

- 6 lode waste samples (5 PAF / 1 UC),
- 2 hanging wall slate (1 PAF / 1 NAF),
- 6 footwall slate (3 PAF / 3 NAF), and
- 1 footwall limestone sample (NAF)

Overall, the results indicate that sulphate-S typically represents a relatively small fraction of the total sulphur content in Dugald River waste rock. There was one lode waste sample where sulphate-S was 35% of total sulphur, but in most other cases sulphate-S represented less than 10% of total sulphur. This means that sulphide-sulphur, indirectly calculated as the difference between the total and sulphate-S values, accounted for the vast majority of the sulphur present in Dugald River waste samples tested.

As a further check, measurements were also made of chromium reducible sulphur, which directly quantifies sulphidic-sulphur forms. The chromium reducible sulphur contents of the 15 samples were essentially the same as the sulphide-S contents calculated by difference from the total-S and sulphate-S assays. This similarity adds veracity to the finding that sulphur is most likely to occur as sulphide.

## 6.2 Sulphur Reactivity

The kinetic NAG procedure was used to gain an insight into the reactivity of sulphides within Dugald River waste rock and to obtain a quick, qualitative assessment of the likely lag time for acidification of PAF waste rock to occur under field conditions. The kinetic NAG test is similar to the standard NAG test where a sample is oxidised with hydrogen peroxide, except that the pH and temperature of the NAG liquor are constantly recorded during the reaction phase of the test. The reaction kinetics are then extrapolated to the field situation using correlations previously derived from an extensive database comprising results of kinetic NAG tests, leach column tests, and field observations across a wide range of rock types.

Although kinetic NAG testing is not a replacement for column leach tests where reactions occur at real time, the profiles obtained by the accelerated procedure provide a qualitative estimate of the lag period to the extent that acidification of PAF rock is likely to occur rapidly (weeks to months), within the short term (many months to one or two years), or medium to long term (several years).

Five PAF samples were selected for kinetic NAG testing as follows:

MMG / EGi Codes	Lithology	%S	ANC	NAPP	ARD Class
80454 / 40892	Lode waste	10.46	34	286	PAF
80429 / 40867	Lode waste	3.32	19	83	PAF
80443 / 40881	Footwall slate	7.88	21	220	PAF
80438 / 40876	Footwall slate	1.66	11	40	PAF
80483 / 40921	Hanging wall slate	1.99	9	52	PAF

The kinetic NAG test reaction profiles for the five samples are given in Figures 9(a) to 9(e), respectively.

### *Lode Waste Rock –High Sulphur*

The two lode waste samples (Figures 9a and 9b) exhibited similar reactivities under NAG test conditions. The pH profiles for both samples were indicative of high rates of sulphide oxidation and there was no evidence of any circum-neutral buffering which normally indicates a lag. The starting pHs were relatively low at 4.0 and 4.8, respectively, and both liquors rapidly acidified to around pH 3 within 8 and 9 minutes,

respectively. There was some buffering between pH 3 to 2 (as indicated by a small plateau in the pH curve) presumably associated with their respective ANC's of 34 and 19 kg H<sub>2</sub>SO<sub>4</sub>/t, but with ongoing oxidation both samples eventually acidified to less than pH 1 within about one and a half hours. The pH minimums corresponded with rapid increases in temperature, with the NAG liquors effectively boiling primarily as a consequence of catalytic decomposition<sup>6</sup> of the peroxide.

Overall, the acidification patterns exhibited by the two high sulphur lode waste samples under NAG test conditions are consistent with such material exhibiting high reactivity and, based on previous laboratory and field testing of waste rock at other sites with similar reaction profiles, it is likely that lode waste similar to the two test samples would exhibit little, if any, lag period if exposed to atmospheric conditions in the field. The results suggest that acidification would likely occur within months rather than years<sup>7</sup>.

#### *Footwall Slate –High Sulphur*

The high sulphur footwall slate sample also reacted strongly in the kinetic NAG test (Figure 9c). As was the case with the high sulphur lode waste samples there was no initial circum-neutral pH plateau that normally signifies a significant lag, but the rate of acidification was slower than for the lode waste samples even though the sulphur content was equally high at 7.88 %S. It took approximately 49 minutes for the pH of the NAG liquor to acidify to pH 3 from a starting point of pH 5.2, roughly 5-times longer than for the lode waste samples. There was again some buffering between pH 3 to 2, and the pH minimum of less than 1 occurred after about 100 minutes (similar to the lode samples) corresponding with a sharp increase in temperature.

The reason for the slower rate of acidification of the footwall slate sample is not clear. The ANC of the slate sample was relatively low at 21 kg H<sub>2</sub>SO<sub>4</sub>/t and comparable to the neutralization capacities of the two lode waste samples. It is possible that the slower rate of acidification relate to differences in the forms of sulphides present. This aspect will be examined further when the sulphur speciation data become available.

The reaction kinetics exhibited by the footwall slate sample under NAG test conditions suggests that such material might respond slower than the lode waste in the field if exposed to atmospheric conditions. However, given the high sulphide content and the limited availability of inherent neutralisation capacity it is expected that any lag period would be relatively short. Based on the reaction kinetics exhibited in the NAG test it is expected that any field lag would be less than a year, and possibly no more than several months.

---

<sup>6</sup> The temperature of the NAG solution also provides an insight into sulphide reactivity. Some of the initial temperature rise may be attributed to the oxidation of pyrite, which is an exothermic (heat generating) process. However, as the oxidation process continues and soluble metals are released, there is an increasing tendency for the hydrogen peroxide to catalytically decompose, a process that is also exothermic. This markedly accelerates the heating of the NAG solution. The main catalyst for peroxide decomposition is likely to be dissolved iron that is released during pyrite oxidation.

<sup>7</sup> The lag times provided in this report should be used as a guide only and are based on correlations previously derived by EGI from comparison of kinetic NAG profiles with results from real time testing of the same materials (e.g. leach column tests) and field observations at actual mine sites.

#### *Footwall and Hanging Wall Slate – Moderate to High Sulphur*

The kinetic NAG test results for the hanging wall and footwall slate samples with moderate to high sulphur contents are given in Figures 9d and 9e, respectively. The profiles for the two samples were very similar, reflecting the fact that they also had similar acid forming characteristics. As noted above, the respective sulphur contents were moderately high at 1.66 and 1.99 %S, the ANC's were relatively low at 11 and 9 kg H<sub>2</sub>SO<sub>4</sub>/t, and the NAPPs were comparable at 40 and 52 kg H<sub>2</sub>SO<sub>4</sub>/t.

The pHs were initially between above 5 but again there were no pH plateaus to suggest that such materials could produce circum-neutral drainage for any length of time if exposed to atmospheric conditions. The pHs of both NAG liquors decreased steadily with time, reaching pH 3 within 83 and 36 minutes, respectively. This rate of pH decrease would suggest a field lag of the order of months to a year, rather than several years. The initial rapid pH decreases were followed by more gradual declines to around pH 1.5, but unlike the high sulphur samples discussed above, there accompanying temperature rises were relatively modest, peaking at around 40 °C after nearly 5 to 6 hour of reaction time.

#### *Summary of Implications for Field Behaviour*

Overall, the results of the kinetic NAG tests suggest that sulphidic lode waste and PAF slate from the hanging wall and footwall adjoining the lode which has a low ANC and a sulphur content exceeding 1.5 %S will be highly reactive and could acidify within several months of exposed to atmospheric conditions.

However, it should be noted that only a limited number of samples with moderate to very high sulphur contents were subjected to kinetic NAG testing. The lag period for PAF waste rock that contains substantially less than 1.5 %S and/or has an ANC substantially above the ANC's of the test samples could extend for much longer, with the onset of acidic conditions delayed beyond a year and possibly for several years.

Some long-term column leach tests were carried out as apart of the AARC (2008) geochemical study (see Section 9) and further column testing is planned for samples from the current study. These column tests will provide more information on sulphide reactivity and lag time under real-time condition.



## 7.0 Elemental Composition of Dugald River Waste Rock

Multi-element scans were run on 15 drill core samples from the current study. They included three samples representing hanging wall slate and two samples from each of the other lithologies. As a general rule, one of the chosen samples from each lithology had a sulphur content towards the top of the concentration range for that lithology, whilst the other sample had a sulphur content that was typically around mid-range. The samples selected were as followed:

MMG / EGi Codes	Lithology	%S	ANC	NAPP	NAG	ARD Class
80466 / 40904	Calc-silicate	0.47	62	-48	0	NAF
80448 / 40886	Calc-silicate	1.57	210	-161	0	NAF
80442 / 40880	Mafic feldspar porphyry	<u>0.01</u>	72	-72	0	NAF
80424 / 40862	Mafic feldspar porphyry	0.77	79	-56	0	NAF
80467 / 40905	White mica schist	0.05	11	-9	0	NAF
80449 / 40887	White mica schist	0.29	9	0	6	PAF
80428 / 40866	Hanging wall slate	0.94	158	-129	0	NAF
80483 / 40921	Hanging wall slate	1.99	9	52	43	PAF
80437 / 40875	Hanging wall slate	4.81	286	-139	0	NAF
80478 / 40916	Lode waste	2.38	219	-146	0	NAF
80454 / 40892	Lode waste	10.46	34	286	138	PAF
80430 / 40868	Footwall slate	1.15	120	-84	0	NAF
80438 / 40876	Footwall slate	1.66	11	40	37	PAF
80436 / 40874	Footwall limestone	1.06	462	-429	0	NAF
80486 / 40924	Footwall limestone	1.69	107	-55	0	NAF

The elemental compositions of the 15 Dugald River waste rock samples are given in Table 4. The samples were assayed for a suite of 35 elements that included: Al, As, Ba, Be, Bi, Ca, Cd, Co, Cr, Cu, Fe, Ga, Hg, In, K, La, Li, Mg, Mn, Mo, Na, Nb, Ni, P, Pb, S, Sb, Se, Sn, Sr, Th, Ti, U, V, and Zn.

Multi-element assays were also carried out as part of AGC-Woodward Clyde (1991) and AARC (2008) geochemical studies of Dugald River waste rock. All samples in the 1991 study and half the samples in the 2008 studies were assayed for a limited range of elements of environmental significance which included: As, Cd, Co, Cu, Hg, Pb, S and Zn. The 2008 samples were also assayed for Ba, Be, Cr, Mn, Ni and V, whilst the 1991 samples were also assayed for Bi<sup>8</sup> and Sb. The assay data from previous studies are given in Appendix B-1.

To provide some relativity to the multi-element data, the compositions of the rock solids were compared to typical background compositions reported for soil. The ratios of the concentrations in Dugald River rock relative to background soil are presented graphically in Figure 10. Those elements that occur substantially

<sup>8</sup> The bismuth contents of all of the samples in the AGC-Woodward Clyde (1991) study were at or below the analytical detection limit of 5 mg/kg, which is relatively high in comparison to concentrations typically found in background soils. As such, the Bi results were not included in this review of elemental enrichments in Dugald waste rock.

above the ratio=1 line in Figure 10 are elevated in comparison to typical soil, whilst elements that occur below the line are deficient relative to typical soil

Geochemical Abundance Indices (GAIs) were also calculated for each sample to provide an indication of elemental enrichments that may have environmental significance. Each GAI was calculated as follows:

$$\text{GAI} = \log_2 [ C / (1.5 * S) ]$$

where C is the concentration of the element in the sample and S is the median soil<sup>9</sup> content for that element. The GAI are truncated to integer increments (0 through to 6, respectively) where a GAI of 0 indicates the element is present at a concentration similar to, or less than, median soil abundance and a GAI of 6 indicates approximately a 100-fold, or greater, enrichment above median soil abundance. The enrichment ranges for the GAI are as follows:

*Little or No Enrichment*

GAI=0 < 3 times median soil

*Slightly Enrichment*

GAI=1 3 to <6 times median soil

GAI=2 6 to <12 times median soil

*Significant Enrichment*

GAI=3 12 to <24 times median soil

GAI=4 24 to <48 times median soil

GAI=5 48 to <96 times median soil

GAI=6 ≥ 96 times median soil

The GAIs for the 15 Dugald River waste rock samples assayed in the current study are given in Table 5, and GAIs for samples from previous studies are given in Appendix B-2. The main purpose of the GAI is to provide an indication of any elemental enrichments that may be of environmental importance. As a general rule, a GAI of 3 or above is considered significant and such an enrichment may warrant further examination.

Samples representing calc-silicate, mafic feldspar porphyry and white mica schist were relatively free of significant (GAI≥3) enrichments. For these lithologies, the only significant enrichment identified was sulphur in one calc-silicate sample.

However, many samples representing hanging wall slate, footwall slate and lode waste were significantly (GAI≤3) enriched with one or more of a range of environmentally important elements. In addition to sulphur, the implications of which have already been discussed in Section 4, many samples from these lithologies were significantly enriched with arsenic, cadmium and zinc, and there were small numbers of samples enriched with copper, lead, mercury, and selenium.

<sup>9</sup> References for median soil data were: (1) Bowen, H.J.M. (1979) Environmental Chemistry of the Elements. Academic Press, London. (2) Berkman, D.A. (1976) Field Geologists' Manual, The Australian Institute of Mining and Metallurgy, Parkville, Victoria, Australia

A summary of the significant enrichments in each lithology (apart from sulphur) is given below:

- Calc-silicate            none
- Mafic feld. porphyry   none
- White mica schist      none
- Hanging wall slate    As (11/28)   Zn (6/28)   Cd (5/28)   Hg (3/28)   Cu (9/28)   Se (1/3)
- Lode waste             As (4/6)      Zn (2/6)      Cd (5/6)      Hg (4/6)      Pb (2/6)      Se (1/2), Mn (1/6), Bi (1/2)
- Footwall slate         As (8/21)    Zn (4/21)    Cd (6/21)    Hg (1/21)    Pb (2/21)    Cu (1/21)
- Footwall limestone   As (3/14)    Zn (2/4)

*(ratios shown are the number samples significantly enriched compared to the total assayed)*

The enriched elements listed above form an elemental association that is commonly reported for a hydrothermal base metal deposit, hence their occurrence within the lode waste and the hanging wall and footwall slate adjoining the lode is expected. However, they are all regarded as environmentally important because of their potential toxicological effects on humans and/or aquatic life. Biological systems are particularly sensitive to metals such as zinc and copper, and there are obvious health implications in relation to elevated concentrations of mercury, cadmium and lead.

Zinc, copper and cadmium are usually highly mobile under acidic conditions and it is likely that significant concentrations of these metals would occur in any acidic drainage produced by PAF waste that is exposed to atmospheric conditions.

There may also be potential for leaching of arsenic, although the solubility of arsenic is often difficult to predict as its solubility and geochemical behaviour in geological systems is often controlled by adsorption or co-precipitation reactions involving other elements (e.g. iron at lower pHs and calcium at higher pHs).

The potential for leaching of environmentally important elements from Dugald River waste rock is considered further in Section 8.

## 8.0 Solute Leaching from Dugald River Waste Rock

Batch extraction tests were carried out on the 15 samples selected for multi-element analysis (see Section 7) to assess the potential for mobilisation of potentially hazardous elements from Dugald River waste rock. Three extractants were used, namely deionised water, 0.05M sulphuric acid, and hydrogen peroxide. The extractions with water and sulphuric acid were based on the Australian Standard leaching Procedure (ASLP) and involved leaching of crushed ( $\leq 4$  mm) material at a solid:liquor ratio of 1:20 on an end-over-end shaker for a period of 18 hours. The peroxide extractions were based on the single-stage NAG test and involved over-night oxidation and leaching of pulverised sample at a solid:liquor ratio of 1:100.

The main objectives of the extraction tests were as follows:

- Deionised water - To provide an indication of the likely solubility of elements in freshly mined rock at the existing pH of the material.
- Dilute Acid - To assess the potential for elemental release from NAF waste rock that may be subject to acidic conditions imposed from some other source (*i.e.* overlying PAF rock).
- Peroxide - To assess elements that could potentially be released from the same rock following an extended period of exposure to atmospheric conditions resulting in significant sulphide oxidation. Depending on the particular rock type, the oxidation process may result in formation of *acidic rock drainage* (*e.g.* PAF Iode waste) or generation of *neutral mine drainage* (*e.g.* NAF calc-silicate or footwall limestone with elevated sulphur and high to very high ANC).

The compositions of extracts from tests involving deionised water, dilute acid and peroxide are given in Tables 6 to 8, respectively. A statistical summary of the results for elements that are generally regarded as environmentally important is also presented graphically in Figure 11. This figure illustrates the concentration range, 20-80 percentile band, and average concentrations for Al, As, Cd, Co, Cr, Cu, Fe, Hg, Mn, Ni, Pb, Sb, Se, Sn, and Zn. Because the peroxide extractions were carried out at one-fifth the solid:liquor ratio than was used for the water and acid extractions, a five-times adjustment factor was applied to peroxide results to provide a more realistic comparison of extraction methods in Figure 11.

### *Water Extractions*

Regardless of the ARD classifications, the water extracts of all 15 waste rock samples were circum-neutral to alkaline, with pHs of 7.4 to 8.5, respectively. The pH values are consistent with the samples containing some reactive carbonate, and in most cases having moderate to high ANCs.

Overall, there was little difference in the chemical compositions of the water extracts. The only differences of any substance was that the two NAF calc-silicate samples produced extracts with markedly higher concentrations of calcium (48 and 221 mg/L) and sulphate (113 and 549 mg/L) compared to extracts from

other samples. The elevated calcium and sulphate concentrations suggests the presence of some readily-soluble gypsum or anhydrite within the calc-silicate.

One of the hanging wall slate samples also had slightly elevated concentrations of calcium (22 mg/L) and sulphate (49 mg/L), but for all other extracts the concentrations were relatively low, with calcium ranging from <1 to 11 mg/L and sulphate ranging from <1 to 20 mg/L. There was also minimal release of magnesium (<1 to 2 mg/L), potassium (<1 to 4 mg/L) or sodium (<1 to 2 mg/L).

Overall, the concentrations of environmentally important elements in the water extracts were consistently low and commonly less than the analytical detection limits. Mercury and cadmium were consistently below the detection limit of 0.0001 mg/L, cobalt, chromium, copper, lead, nickel, antimony and tin were below or close to the 0.001 mg/L detection limit, and selenium was below the 0.01 mg/L detection limit. Arsenic was also low, with all but two extracts containing less than 0.006 mg/L.

Only the lode waste samples exhibited some minor leaching of metals. The water extract of one of the lode samples contained 0.42 mg/L of zinc and 0.33 mg/L of barium. There were also traces of nickel (0.006 mg/L) and lead (0.004 mg/L), whilst the other lode extract had a trace of arsenic (0.016 mg/L).

Such results from the water extractions suggest that the potential for leaching by natural rainfall of environmentally important elements such as As, Cd, Co, Cr, Cu, Hg, Mn, Ni, Pb, Se, Sn, and Zn will be inconsequential for freshly mined rock similar to the samples tested.

#### *Acid Extractions*

The dilute acid extraction involved 0.05M H<sub>2</sub>SO<sub>4</sub>. This strength has a pH of 1.6, an acidity equivalent to 5000 mg CaCO<sub>3</sub>/L, and a sulphate concentration of approximately 4,800 mg/L. From an ARD perspective, a pH of 1.6 represents an extreme case but the acidity<sup>10</sup> and sulphate concentration are of a magnitude commonly observed in ARD from actively oxidising PAF rock. The total amount of acid added to each sample was equivalent to 98 kg H<sub>2</sub>SO<sub>4</sub>/t.

As expected, there was some neutralisation of acid by some of the samples, in particular those with high ANCs. Three of the four samples with ANCs exceeding 200 kg H<sub>2</sub>SO<sub>4</sub>/t produced extracts of pH 5.3 to 5.4, while the fourth sample raised the pH to 3.3. It is expected that some neutralisation would also have occurred with most of the other 11 samples that had lower ANCs, but overall pHs remained low at between pH 1.5 to 2.1.

A defining feature of the acid extractions was that there was significant release of calcium as a direct consequence of the neutralisation processes. Calcium concentrations ranged from 20 to 164 mg/L in the acid extracts for samples with relatively low ANCs (i.e. ≤34 kg H<sub>2</sub>SO<sub>4</sub>/t), and from 393 to 874 mg/L for the higher ANC samples. The latter range equates to ANC equivalent of 19 to 43 kg H<sub>2</sub>SO<sub>4</sub>/t if it is assumed that

---

<sup>10</sup> In most cases the acidity of ARD predominantly results from dissolved iron and aluminium, with free acid (H<sub>2</sub>SO<sub>4</sub>) usually a minor contributor.

the calcium was derived from calcite<sup>11</sup> dissolution and there was no re-precipitation<sup>12</sup> of the calcium into other forms.

In addition to calcium, there was significant release of iron, aluminium and manganese from most samples. The concentrations of iron in the acid extracts ranged from 4 to 60 mg/L (average 25 mg/L), aluminium from 0.3 to 22 mg/L (average 8 mg/L), and manganese from 2.8 to 137 mg/L (average 24 mg/L). Concentrations of iron and aluminium were greatest in extracts of low pH, which is consistent with the solubilities of both these elements being highly pH-dependent.

Mercury, tin and selenium remained below their respective detection limits of 0.0001, 0.001 and 0.1 mg/L. The concentration ranges for most of the environmentally important elements were generally higher in the acid extracts compared to the water extraction results, typically by an order-of-magnitude as illustrated in Figure 11.

Notwithstanding this general increase, the concentrations in most cases were still comparatively low and indicative of only limited elemental release despite the low pH condition imposed on the samples. For example, concentrations of cadmium and antimony were less than 0.01 mg/L, and the concentrations of arsenic, cobalt, chromium, copper and nickel were less than 0.1 mg/L.

However, there was a significant release of zinc from one of the lode waste samples (as per the water extract) producing concentration of 5.8 mg/L in the acid extract. For all other samples the zinc concentrations were much lower, typically around 0.1 to 0.3 mg/L.

#### *Peroxide Extractions*

As noted above, the results of the water leach tests provide an indication of the initial solubility of elements in freshly mined rock. However geochemical changes are likely to occur if sulphidic rock is exposed to conditions in which oxidation can occur, which could alter the potential for leaching of metals and other environmentally important elements. The purpose of the peroxide extractions, which followed the same procedure as the NAG test, was to highlight those elements that could potentially be released from Dugald River waste rock during an extended period of exposure to atmospheric conditions.

It should be noted that only four of the samples tested were classified as PAF. They included lode waste sample, one white mica schist, one hanging wall slate and one footwall slate. The pHs of these samples after reaction ranged from 2.3 to 3.5. Some of the NAF samples also had significant sulphide contents, but the ANCs were generally high to very high and the pH of the peroxide extracts were invariably circum-neutral at between pH 6.2 to 9.2.

---

<sup>11</sup> In the case of calc-silicate it is likely that some of the calcium derived from other sources (e.g. dissolution of gypsum or anhydrite) as calcium concentration was also relatively high in the corresponding water extracts.

<sup>12</sup> It is likely that some calcium re-precipitated as gypsum in some extracts given that the sulphate concentrations at the end of the test were generally lower than at the start, particularly in the case of samples with higher ANC where carbonate dissolution was greatest. This being the case, the amounts of ANC dissolution would have been higher than those indicated by dissolved calcium.



It should also be noted that the composition of a peroxide extract at the end of the 18 hour reaction period should not be regarded as necessarily representative of the drainage quality that might be produced by such a material under field conditions as the concentrations of various elements are fundamentally influenced by the configuration of the test procedure, including the soil:liquor ratio, the extent of oxidation, and the degree of any acidification that might occur. Rather, the intent of the peroxide test was to highlight elements that might be released in significant amounts as a consequence of sulphide oxidation. To this end, and to provide a more apt comparison of the peroxide, water and acid leach results in Figure 11, the elemental concentrations in the peroxide extracts were multiplied by five to adjust for the different solid:liquor ratio that was used in the peroxide (NAG test) extraction.

This comparison suggests that the elements which had a higher propensity for release under oxidising conditions included zinc, lead, nickel, manganese, copper, cobalt, and to a lesser extent arsenic. However, significant releases of these elements were almost exclusively confined to the four PAF samples that acidified during the peroxide extraction. With the NAF samples the concentrations in the peroxide extracts were typically at trace values only. Elements that showed little or no propensity for release regardless of pH included mercury, tin, chromium, selenium and antimony.

## 9.0 Column Leach Testing of Dugald River Waste Rock

MMG is currently assessing commissioning long-term column leach tests involving some waste rock samples discussed in this report. The results of such testing would complement the findings of previous column leach tests that were commissioned by AARC in August 2008 and operated for either 44 weeks or 68 weeks.

The main objective of the column tests is to quantify the longer-term geochemical behaviour of different waste rock lithologies at real time under conditions that are conducive to sulphide oxidation and metals leaching. The column leach testing program will also provide data on rates of sulphide oxidation and acidification of PAF waste rock such as occurs within the vicinity of the lode and in the adjoining hanging wall and footwall slate, and more accurate water quality data for drainages that could emerge from PAF and NAF waste rock stockpiled at the surface.

The column tests commissioned by AARC involved composites of drill core samples representing the following waste rock types:

- Column 1 - hanging wall slate (uncertain),
- Column 2 - footwall limestone (NAF),
- Column 3 - PAF waste mixture (comprising lode waste and pyritic/mineralised footwall slate)
- Column 4 - footwall slate (NAF),
- Column 5 - calc-silicate (NAF),
- Column 6 - calc-silicate & mafic feldspar porphyry mix (NAF),
- Column 7 - mica schist (NAF),

The acid forming characteristics of the samples are detailed in Appendix C-1. Briefly, the samples exhibited the following characteristics:

- The PAF waste mixture had a very high acid forming potential. The sulphur content was 9.47 %S, and the NAPP was corresponding high at 254 kg H<sub>2</sub>SO<sub>4</sub>/t.
- The hanging wall slate was borderline with respect to ARD potential and the ARD classification was uncertain. It contained 2.39 %S and had a small positive NAPP of 2 kg H<sub>2</sub>SO<sub>4</sub>/t, but it did not acidify when reacted in the NAG test.
- All other samples were classified as NAF. They had substantially lower sulphur contents (0.02 to 0.96 %S) and high to very high ANCs (80 to 222 kg H<sub>2</sub>SO<sub>4</sub>/t).

The column tests were undertaken by ALS Brisbane, generally in accordance with the *Free Draining Leach Column Procedure* outlined in the AMIRA P387A Project ARD Test Handbook<sup>13</sup>. Each column comprised 2.5 kg of crushed core (nominally less than 10 mm<sup>14</sup>) and was leached under free-draining conditions with deionised water on a monthly leach cycle.

The monthly leachate collections were assayed for pH, EC, alkalinity/acidity and sulphate concentration. A multi-element scan was also run on every second collection. The leachate assay results for the column tests are tabulated in Appendix C. Plots of leachate pH, sulphate and calcium concentration through time are also given in Figures 12 to 14, respectively.

#### NAF Waste Samples

The five NAF samples produced circum-neutral leachates (Figure 12) throughout the 44 week test period and the major ion chemistries were dominated by sulphate (Figure 13) and calcium (Figure 14). The average pH, alkalinity, sulphate concentration and calcium concentration for the five NAF columns during the test period were as follows:

Column Test	Lithology	Average pH	Average Alk (mg/L)	Average SO <sub>4</sub> (mg/L)	Average Ca (mg/L)
Column 2	Footwall limestone	7.8	30	44	17
Column 4	Footwall slate	7.6	21	46	18
Column 5	HW Calc-silicate	8.7	54	6	7
Column 6	HW Calc-sil / Mafic porphyry	8.6	39	8	7
Column 7	HW Mica schist	8.4	27	4	7

Figure 15 shows a statistical summary of the combined leachate quality results for the five NAF leach column tests. The results are consistent with the findings of the water extraction tests reported in Section 8. Apart from occasional trace concentrations of zinc (up to 0.2 mg/L) and manganese (up to 0.35 mg/L) there was no evidence of significant release of environmentally important elements from any of the NAF waste rock samples during the 12 month period. Mercury and cadmium were consistently below or close to the analytical detection limit of 0.0001 mg/L, antimony, arsenic, chromium, cobalt, copper, lead nickel and tin were below or close to the 0.001 mg/L detection limit, and selenium was below the 0.01 mg/L detection limit.

The concentrations reported for zinc ranged up to 0.2 mg/L but around half of leachate collections contained less than the 0.005 mg/L detection limit and the average zinc concentration across all of the NAF samples

<sup>13</sup> EGi was a contributing author of the AMIRA handbook and the column leach procedure described was developed by EGi and is currently used in EGi's laboratory. This column set-up will also be employed for the planned new column tests involving Dugald waste rock.

<sup>14</sup> The nominal minus 10 mm size material used by ALS for the 2.5 kg column tests was larger than the nominal minus 4 mm specified in the handbook.

was less than 0.02 mg/L. Similarly for manganese, concentrations ranged up to 0.35 mg/L but the average overall was only 0.06 mg/L.

#### *PAF Waste Mixture*

Column 3 contained a mixture of drill core samples representing PAF lode waste and PAF mineralised and pyritic footwall slate. The acid forming characteristics of the sample were typical of the lode waste samples included in the current study in that it had a high sulphur content (9.47 %S), a low to moderate ANC (36 kg H<sub>2</sub>SO<sub>4</sub>/t) and a high NAPP (254 kg H<sub>2</sub>SO<sub>4</sub>/t). The static NAG test also confirmed that the sample had a high acid potential under oxidising conditions.

The initial leachate draining from the column was pH neutral, similar to what was observed in the water extraction tests that were carried out on this type of waste rock. Leachate pH remained neutral for the first 12 weeks, but thereafter steadily decreased with time (see Figure 12). When the column test was stopped at 68 weeks the pH of leachate had decreased to 4.4.

There was considerable variability in the concentration of sulphate in column leachate during the test, but overall there was a general upward trend with time. The average concentration for the 68 week test period was 99 mg/L. This average is around twice that recorded for leachates from the columns containing the footwall slate (Column 2) and footwall limestone (Column 3), and more than an order-of-magnitude greater than for leachates from the other NAF columns. However, the sulphate concentrations *per se* were relatively low in comparison to what often occurs in acid rock drainage from highly pyritic rock. With such materials it is not uncommon to find sulphate concentrations in the order of several thousand mg/L. Indeed, sulphate concentrations of that magnitude were recorded in an identical column leach test involving process tailings from the Dugald River project that was carried out by EGi<sup>15</sup> in 2008-9. The reason for the relatively low sulphate concentrations in leach from the PAF waste sample is not known, but it is probable that the particle size and rock strength of the test material (nominally < 10 mm) were factors affecting the exposed surface area of sulphides.

The acidification of the PAF waste mix was accompanied by increased leaching of iron, zinc, manganese and aluminium as illustrated in Figure 16. The maximum concentrations recorded during the column test were 18.1, 9.4, 6.3, and 0.47 mg/L, respectively.

However, there was only trace leaching of other environmentally important elements, with many elements occurring in leachate at concentrations below or close to the limits of analytical detection. For example, mercury was less than the detection limit of 0.0001 mg/L, arsenic, chromium, lead antimony and tin were less than 0.001 mg/L, and selenium was less than 0.01 mg/L. The average and range of concentrations recorded for environmentally important elements were as follows:

---

<sup>15</sup> EGi (2009). Geochemistry and column leach testing of tailings. Dugald River Zinc Project, Queensland. Final Report. Prepared for Oz Minerals Australia Limited by Environmental Geochemistry International Pty Ltd. Document No. 6412/877, July 2009.

The Dugald tailings sample had a sulphur content of 7.9 %S and was strongly acid generating with a NAG capacity of 86 kg H<sub>2</sub>SO<sub>4</sub>/t. Under column leach testing the tailings acidified to around pH 3.5 within the first few months of leaching and over the course of the 52 week column test the concentration of sulphate in leachate ranged from 1640 to 5720 mg/L and averaged 3080 mg/L.

---

Element	Average	Range
Al	0.19	(0.02 - 0.47)
As	<0.001	
Cd	0.005	(0.0002 - 0.009)
Co	0.015	(0.003 - 0.04)
Cr	<0.001	
Cu	0.01	(<0.001 - 0.03)
Fe	8.3	(<0.05 - 18.1)
Hg	<0.0001	(<0.0001 - 0.0004)
Mn	2.4	(0.41 - 6.3)
Ni	0.06	(0.01 - 0.14)
Pb	0.015	(<0.001 - 0.03)
Sb	<0.001	
Se	<0.01	
Sn	<0.001	
Zn	4.02	(0.10 - 9.4)

#### *Hanging Wall Slate*

Column 1 contained a composite of drill core interval representing both NAF and PAF hanging wall slate. Static testing of the sample indicated a sulphur content of 2.39 %S (which equates to a maximum acid potential of 73 kg H<sub>2</sub>SO<sub>4</sub>/t), and an ANC of 71 kg H<sub>2</sub>SO<sub>4</sub>/t. These results mean that the acid-base characteristics of the sample were evenly balanced, with a NAPP of only 2 kg H<sub>2</sub>SO<sub>4</sub>/t. The sample didn't acidify when reacted in a single addition NAG test, but the acid-base account denotes it was borderline with respect to ARD potential.

The overall pH profile for the hanging wall slate sample (see Figure 12) was comparable to that profile exhibited by the PAF waste mix, despite having a much lower sulphur content (albeit still relatively high) and about double the ANC. The initial leachate from the column was circum-neutral but after the first few months there was an overall downward trend in pH, with values less than 5 recorded for the last two collections at weeks 64 and 68. A lag period of only a few months is unusual for rock which has an ANC of 71 kg H<sub>2</sub>SO<sub>4</sub>/t, which normally would be considered to be in the moderate to high range and would normally be expected to provide a lag of at least a year and probably several years. The absence of such an extended lag suggests that the ANC within the slate was not readily available for reaction with acid produced by sulphide oxidation.

The decrease in pH was again accompanied by increases in the concentrations of iron, zinc, manganese and aluminium, but not to the same extent as reported for the PAF waste mix. By the end of the test the concentrations of these metals had increased to 10.4, 0.50, 0.51 and 0.19 mg/L, respectively. Other environmentally important elements were either below detection or occurred at trace concentrations only.

## 10.0 Summary and Implications for Dugald River Waste Rock Management

This report presents the results and findings of geochemical analysis of drill core samples representing waste rock lithologies that will be mined during development and operation of the Dugald River project. The geochemical program involved static testing of 72 drill core samples selected by MMG to assess their potential for generation of acid rock drainage, and also the potential for metals leaching under both acidic and neutral drainage conditions. In addition to the 72 samples tested by EGi, data from previous geochemical studies carried out by AARC (2008) and AGC-Woodward Clyde (1991) were compiled into a single geochemical database to enhance the evaluation of acid generation and metals leaching characteristics of the different waste rock types.

### *Main Findings*

Overall, results for 211 samples were assessed. They included 31 samples representing calc-silicate, 7 mafic feldspar porphyry, 17 white mica schist, 52 hanging wall slate, 18 lode waste, 44 footwall slate, and 42 footwall limestone. The results for these samples suggest that:

- Waste rock from the calc-silicate, mafic feldspar porphyry, white mica schist lithologies associated with the mining of copper ore, and also waste rock from the footwall limestone lithology will be non-acid forming (NAF), with the calc-silicate and footwall limestone likely to have high to very high neutralisation capacity.
- Waste rock from within the lode zone will almost invariably be potentially acid forming (PAF) and have a high to very high capacity for acid generation if exposed to atmospheric conditions. It is also likely that some slate waste rock from the adjoining hanging wall and footwall will be pyritic and strongly PAF. Approximately 54% of the hanging wall slate samples tested, and 20% of the footwall slate samples tested were classified as PAF.

Elemental analyses of selected samples were also carried out to identify any enrichments that might be environmentally significant in terms of impacting on the quality of mine water and waste dump seepage. No significant metal or metalloid enrichments were identified in the calc-silicate, mafic feldspar porphyry and white mica schist but many of the hanging wall slate, footwall slate and lode waste samples were highly enriched with one or more of a range of environmentally important elements on comparison to concentrations typically occurring in background soils. The most prevalent enrichments were arsenic, cadmium and zinc. There was also less frequent enrichment with copper, lead, mercury, and selenium.

The enriched elements listed above form an elemental association that is commonly reported for a hydrothermal base metal deposit, hence their occurrence within the lode waste and the hanging wall and footwall slate adjoining the lode is expected. However, they are all regarded as environmentally important in terms of water quality, human health and/or aquatic life.

A series of batch extraction tests were carried out on selected samples to assess the potential for mobilisation of environmentally important elements under both acidic and neutral mine drainage conditions. Also, the results of column leach tests previously commissioned by AARC were reviewed to identify elements that might be released from different waste rock lithologies when exposed to atmospheric conditions. Elements that exhibited a higher propensity for release under oxidising conditions included zinc, lead, nickel, manganese, copper, cobalt, and to a lesser extent arsenic. However, significant releases of these elements were almost exclusively confined to PAF waste once acidification had occurred. With the NAF rock producing neutral drainage, the concentrations of environmentally important elements were typically at trace values only. Elements that showed little or no propensity for release regardless of pH included mercury, tin, chromium, selenium and antimony.

#### *Implications for Waste Rock Management*

The results of this and previous studies suggest that most lode waste and some pyritic slate in the hanging wall and footwall adjoining the lode will have a high acid generating potential and consequently a high level of management will be required to limit sulphide oxidation and minimise the risk of ARD generation occurring if such material is brought to the surface and exposed to atmospheric conditions. Clearly, highly PAF waste should be preferentially used as underground fill where possible. For PAF waste that needs to be stockpiled temporarily at the surface, or permanently placed within a dump, it is recommended that mining and handling procedures are developed that will allow selective placement of PAF waste in a manner that minimises rainfall infiltration (to limit leaching) and oxygen ingress (to limit oxidation). Prevention or control of acid rock drainage within stockpiles or dumps of pyritic waste rock will require adoption of strategies that involve one or more of the following:

- In-situ neutralisation of acid generation via blending of PAF rock with other materials that are non-acid forming, in particular high carbonate materials such as the footwall limestone or hanging wall calc-silicate;
- Minimisation of pyrite oxidation processes within dumped PAF waste via:
  - isolation and encapsulation of PAF rock within cells within the core of a dump or stockpile,
  - prevention of convective air movement by constructing dumps in small, compacted lifts,
  - construction of intermediate or final barrier layers which limit oxygen diffusion;
- Minimisation of acid drainage migration via:
  - controls on surface drainage,
  - incorporation of layers of low hydraulic conductivity.

The two key ingredients for pyrite oxidation are water and oxygen. Whilst it is generally best practice to divert surface waters away from dumps, and to place final cappings that minimise rainwater ingress, such measures are unlikely to produce a dump in which the moisture content is low enough to prevent sulphide oxidation. In the wet-dry climatic setting that occurs at the Dugald River site, the only practical mechanism for controlling sulphide oxidation will be to limit the movement of atmospheric oxygen into stockpiled material. This can generally be achieved by either burial and isolation of PAF rock within cells within the core of a



dump, or by construction of an outer cover that incorporates a layer with a low air-filled porosity which will act as a barrier to inward gaseous movement.

It is essential that all PAF rock is excluded from the area under the outer slope of dumps where convective air movement tends to be greatest. PAF rock should also be excluded from the base layer and from existing drainage lines so that the under-drainage is not in contact with sulphidic mineralised rock. To the extent possible, limestone or calc-silicate should be placed in drainage lines to impart some alkalinity to drainage prior to emergence at the dump toe.

As it is expected that PAF waste will be a relatively small percentage of total waste, there should also be opportunities for blending with high carbonate NAF rock prior to encapsulation within cells within the dump core. Ideally, blending would involve co-dumping of high carbonate rock such as limestone or calc-silicate with PAF rock to create an overall blend that is non-acid forming. Even if a NAF blend cannot be achieved, the high ANC of the blend would be expected to provide a very long lag which would prevent acidification pending possible future use as underground fill.

It is essential that no PAF rock is unduly exposed to atmospheric conditions, and intermediate barrier layers of NAF rock should be used to encapsulate PAF lifts prior to the wet season. Progressive encapsulation of PAF rock using intermediate cover layers would reduce leaching of PAF rock during dump construction, and in the longer term such layers would also provide a source of alkalinity to any pore water moving down into PAF rock zones within a dump.

It is essential that any stockpiled waste rock remaining at the surface at mine closure has a final cover layer comprising only NAF material. Such a cover would serve as a revegetation layer and provide circum-neutral surface runoff. The design of the final cover can be developed as mining proceeds and the NAF/PAF schedule for waste rock is refined, but under the climatic conditions prevailing at the River site a *Store and Release* cover system would likely provide the necessary level of control on rainfall infiltration to prevent significant leaching of any PAF rock encapsulated within cells within the dump core.

# Tables

**TABLE 1: Acid Forming Characteristics of Dugald River waste rock - Samples arranged by drill hole**

MMG Sample ID	EGi Code	Hole No.	From (m)	To (m)	Interval (m)	Lithology	EC	Existing pH	Total %S	MPA	ANC	ANC/MPA Ratio	NAPP	NAG	NAGpH	ARD Class
80421	40859	DR315	284.0	284.5	0.5	Footwall slate	331	8.3	0.90	28	220	8	-193	0	7.8	NAF
80422	40860	DR315	304.0	304.5	0.5	Footwall limestone	216	8.1	0.68	21	456	22	-435	0	8.3	NAF
80423	40861	DR322	104.0	104.5	0.5	Calc-silicate	221	8.4	<u>0.01</u>	0	261	853	-261	0	8.8	NAF
80424	40862	DR322	150.0	150.5	0.5	Mafic feldspar porphyry	315	8.5	0.77	24	79	3	-56	0	8.9	NAF
80425	40863	DR322	288.0	288.5	0.5	Footwall slate	416	8.3	0.80	24	82	3	-57	0	7.9	NAF
80426	40864	DR322	310.0	310.5	0.5	Footwall limestone	239	8.2	0.88	27	467	17	-440	0	8.5	NAF
80427	40865	DR324	300.0	300.5	0.5	Hanging wall slate (Si Ab alt)	325	8.5	0.42	13	81	6	-68	0	7.8	NAF
80428	40866	DR324	405.0	405.5	0.5	Hanging wall slate (non sulphide)	176	8.4	0.94	29	158	5	-129	0	8.1	NAF
80429	40867	DR324	423.0	423.5	0.5	Lode (mineralised waste)	212	7.8	3.32	102	19	0.2	83	73	2.2	PAF
80430	40868	DR324	456.0	456.5	0.5	Footwall slate	245	7.9	1.15	35	120	3	-84	0	9.3	NAF
80431	40869	DR324	485.0	485.5	0.5	Footwall limestone	335	8.6	1.53	47	307	7	-260	0	8.2	NAF
80432	40870	DR330	101.5	102.0	0.5	Calc-silicate	346	8.4	<u>0.01</u>	0	134	437	-133	0	8.7	NAF
80433	40871	DR331	197.0	197.5	0.5	Footwall slate	512	8.5	1.18	36	170	5	-134	0	8.3	NAF
80434	40872	DR331	240.0	240.5	0.5	Footwall limestone	146	8.2	1.06	32	451	14	-418	0	9.6	NAF
80435	40873	DR336	382.0	382.5	0.5	Footwall limestone	235	8.3	0.71	22	215	10	-194	0	8.1	NAF
80436	40874	DR337	401.0	401.5	0.5	Footwall limestone	315	8.2	1.06	32	462	14	-429	0	8.9	NAF
80437	40875	DR339	188.0	188.5	0.5	Hanging wall slate (Si Ab alt)	142	8.1	4.81	147	286	1.9	-139	0	8.1	NAF
80438	40876	DR339	241.0	241.5	0.5	Footwall slate	117	8.9	1.66	51	11	0.2	40	37	2.4	PAF
80439	40877	DR339	248.0	248.5	0.5	Lode (mineralised waste)	145	8.2	2.05	63	237	4	-175	0	8.1	NAF
80440	40878	DR339	271.0	271.5	0.5	Footwall limestone	129	7.9	1.28	39	363	9	-323	0	8.0	NAF
80441	40879	DR343	133.0	133.5	0.5	Calc-silicate	139	7.8	0.01	0	82	268	-82	0	9.4	NAF
80442	40880	DR343	416.0	416.5	0.5	Mafic feldspar porphyry	146	8.4	<u>0.01</u>	0	72	235	-72	0	8.6	NAF
80443	40881	DR343	521.0	521.5	0.5	Footwall slate	235	7.6	7.88	241	21	0.1	220	260*	2.0	PAF
80444	40882	DR343	544.0	544.5	0.5	Footwall limestone	246	7.8	0.82	25	229	9	-204	0	7.7	NAF
80445	40883	DR345	351.0	351.5	0.5	Footwall slate	415	7.7	0.57	17	60	3	-42	0	7.8	NAF
80446	40884	DR345	364.0	364.5	0.5	Footwall limestone	329	8.6	0.85	26	199	8	-173	0	7.9	NAF
80447	40885	DR346	449.0	449.5	0.5	Footwall slate	346	8.7	1.61	49	119	2.4	-70	0	7.6	NAF
80448	40886	DR355	435.0	435.5	0.5	Calc-silicate	352	8.5	1.57	48	210	4	-161	0	9.5	NAF

TABLE 1: Continued

MMG Sample ID	EGi Code	Hole No.	From (m)	To (m)	Interval (m)	Lithology	EC	Existing pH	Total %S	MPA	ANC	ANC/MPA Ratio	NAPP	NAG	NAGpH	ARD Class
80449	40887	DR355	501.0	501.5	0.5	Schist	146	8.2	0.29	9	9	1	0	6	3.5	PAF
80450	40888	DR355	576.0	576.5	0.5	Lode (mineralised waste)	216	8.4	11.75	360	7	0	352	297*	2.0	PAF
80451	40889	DR355	636.0	636.5	0.5	Footwall slate	315	8.0	2.18	67	148	2	-82	0	7.5	NAF
80452	40890	DR355	660.0	660.5	0.5	Footwall limestone	429	7.8	0.39	12	152	13	-140	0	7.6	NAF
80453	40891	DR356	52.0	52.5	0.5	Hanging wall slate (Si Ab alt)	276	7.9	0.38	12	392	34	-380	0	7.9	NAF
80454	40892	DR356	181.0	181.5	0.5	Lode (mineralised waste)	186	7.4	10.46	320	34	0	286	348*	2.0	PAF
80455	40893	DR356	215.0	215.5	0.5	Footwall slate	345	7.6	0.87	27	136	5	-109	0	7.8	NAF
80456	40894	DR356	261.0	261.5	0.5	Footwall limestone	329	8.4	1.87	57	435	8	-377	0	7.9	NAF
80457	40895	DR356	263.0	263.5	0.5	Hanging wall slate (non sulphide)	307	7.8	1.07	33	455	14	-423	0	7.5	NAF
80458	40896	DR364	150.0	150.5	0.5	Schist	212	8.3	0.08	2	15	6	-13	0	4.7	NAF
80459	40897	DR364	278.0	278.5	0.5	Footwall slate	246	8.5	0.59	18	140	8	-122	0	7.8	NAF
80460	40898	DR364	306.0	306.5	0.5	Footwall limestone	197	8.6	0.89	27	462	17	-435	0	7.9	NAF
80461	40899	DR366	178.0	178.5	0.5	Footwall limestone	176	8.7	1.32	40	385	10	-345	0	7.6	NAF
80462	40900	DR368	245.0	245.5	0.5	Footwall limestone	203	8.5	0.77	24	516	22	-492	0	8.2	NAF
80463	40901	DR373	338.0	338.5	0.5	Calc-silicate	211	8.3	0.04	1	143	117	-141	0	7.8	NAF
80464	40902	DR373	638.0	638.5	0.5	Footwall slate	242	8.7	1.11	34	111	3	-77	0	8.9	NAF
80465	40903	DR373	671.0	671.5	0.5	Footwall limestone	403	8.6	0.83	25	302	12	-276	0	8.2	NAF
80466	40904	DR379	531.0	531.5	0.5	Calc-silicate	179	8.5	0.47	14	62	4	-48	0	8.4	NAF
80467	40905	DR379	575.0	575.5	0.5	Schist	245	8.7	0.05	2	11	7	-9	0	6.3	NAF
80468	40906	DR379	584.0	584.5	0.5	Hanging wall slate (non sulphide)	225	8.9	0.89	27	159	6	-132	0	7.6	NAF
80469	40907	DR379	631.0	631.5	0.5	Lode (mineralised waste)	312	8.1	13.94	427	398	0.9	28	0*	7.3	UC (NAF)
80470	40908	DR379	671.0	671.5	0.5	Footwall slate	345	8.4	1.56	48	40	0.8	7	3*	3.6	PAF
80471	40909	DR379	715.0	715.5	0.5	Footwall limestone	332	8.3	0.92	28	192	7	-163	0	8.0	NAF
80472	40910	DR388	478.0	478.5	0.5	Footwall slate	199	8.5	0.84	26	103	4.0	-77	0	7.6	NAF
80473	40911	DR388	513.0	513.5	0.5	Footwall limestone	227	8.6	1.22	37	446	12	-409	0	7.7	NAF
80474	40912	DR393	335.0	335.5	0.5	Calc-silicate	235	8.3	0.74	23	212	9	-189	0	7.8	NAF
80475	40913	DR393	358.0	358.5	0.5	Mafic feldspar porphyry	246	8.2	0.01	0	187	612	-187	0	7.5	NAF
80476	40914	DR393	698.0	698.5	0.5	Footwall slate	255	8.9	0.91	28	60	2.2	-32	0	7.6	NAF

TABLE 1: Continued

MMG Sample ID	EGi Code	Hole No.	From (m)	To (m)	Interval (m)	Lithology	EC	Existing pH	Total %S	MPA	ANC	ANC/MPA Ratio	NAPP	NAG	NAGpH	ARD Class
80477	40915	DR395	674.0	674.5	0.5	Mafic feldspar porphyry	142	8.4	0.01	0	169	551	-168	0	7.7	NAF
80478	40916	DR395	769.0	769.5	0.5	Lode (mineralised waste)	222	8.3	2.38	73	219	3	-146	0	7.8	NAF
80479	40917	DR395	932.0	932.5	0.5	Footwall slate	315	8.5	1.13	35	144	4	-109	0	7.6	NAF
80480	40918	DR405	212.0	212.5	0.5	Footwall slate	329	8.4	0.66	20	43	2.1	-23	0	7.9	NAF
80481	40919	DR405	234.0	234.5	0.5	Footwall limestone	276	7.6	0.10	3	127	41	-123	0	7.2	NAF
80482	40920	DR406	216.0	216.5	0.5	Calc-silicate	155	7.7	<u>0.01</u>	0	196	642	-196	0	7.4	NAF
80483	40921	DR406	481.0	481.5	0.5	Hanging wall slate (non sulphide)	242	7.8	1.99	61	9	0.1	52	43	2.4	PAF
80484	40922	DR408	839.0	839.5	0.5	Lode (mineralised waste)	235	7.9	6.12	187	5	0.0	182	219*	2.3	PAF
80485	40923	DR408	889.0	889.5	0.5	Footwall slate	246	8.7	2.12	65	94	1.5	-30	0	7.5	NAF
80486	40924	DR412	36.0	36.5	0.5	Footwall limestone	196	8.3	1.69	52	107	2.1	-55	0	7.6	NAF
80487	40925	DR414	337.0	337.5	0.5	Hanging wall slate (Si Ab alt)	331	8.4	<u>0.01</u>	0	190	621	-190	0	7.3	NAF
80488	40926	DR414	421.0	421.5	0.5	Schist	342	8.2	0.05	2	10	6	-8	0	7.2	NAF
80489	40927	DR414	564.5	565.0	0.5	Lode (mineralised waste)	309	8.6	1.90	58	16	0.3	42	38	2.4	PAF
80490	40928	DR414	599.5	600.0	0.5	Footwall slate	311	8.7	0.98	30	88	2.9	-58	0	7.8	NAF
80491	40929	DR417	58.0	58.5	0.5	Footwall slate	316	8.6	1.18	36	548	15	-512	0	7.7	NAF
80492	40930	DR417	123.0	123.5	0.5	Footwall limestone	321	8.5	0.97	30	444	15	-414	0	7.2	NAF

**KEY**

Existing pH = pH of 1:2 extract

EC = Electrical Conductivity of 1:2 extract (µS/cm)

MPA = Maximum Potential Acidity (kg H<sub>2</sub>SO<sub>4</sub>/t)

ANC = Acid Neutralising Capacity (kg H<sub>2</sub>SO<sub>4</sub>/t)

NAPP = Net Acid Producing Potential (kg H<sub>2</sub>SO<sub>4</sub>/t)

NAG = Net Acid Generation capacity to pH 7.0 (kg H<sub>2</sub>SO<sub>4</sub>/t)

NAGpH = pH of NAG liquor

\* note: NAG values with asterisk are from sequential NAG tests

NAF = Non-Acid Forming

PAF = Potentially Acid Forming

UC = Uncertain Classification

(likely classification given in brackets)

**TABLE 2: Acid Forming Characteristics of Dugald River waste rock - Samples arranged by lithology**

MMG Sample ID	EGi Code	Hole No.	From (m)	To (m)	Interval (m)	Lithology	EC	Existing pH	Total %S	MPA	ANC	ANC/MPA Ratio	NAPP	NAG	NAGpH	ARD Class
80423	40861	DR322	104.0	104.5	0.5	Calc-silicate	221	8.4	<u>0.01</u>	0	261	853	-261	0	8.8	NAF
80482	40920	DR406	216.0	216.5	0.5	Calc-silicate	155	7.7	<u>0.01</u>	0	196	642	-196	0	7.4	NAF
80474	40912	DR393	335.0	335.5	0.5	Calc-silicate	235	8.3	0.74	23	212	9	-189	0	7.8	NAF
80448	40886	DR355	435.0	435.5	0.5	Calc-silicate	352	8.5	1.57	48	210	4	-161	0	9.5	NAF
80463	40901	DR373	338.0	338.5	0.5	Calc-silicate	211	8.3	0.04	1	143	117	-141	0	7.8	NAF
80432	40870	DR330	101.5	102.0	0.5	Calc-silicate	346	8.4	<u>0.01</u>	0	134	437	-133	0	8.7	NAF
80441	40879	DR343	133.0	133.5	0.5	Calc-silicate	139	7.8	0.01	0	82	268	-82	0	9.4	NAF
80466	40904	DR379	531.0	531.5	0.5	Calc-silicate	179	8.5	0.47	14	62	4	-48	0	8.4	NAF
80475	40913	DR393	358.0	358.5	0.5	Mafic feldspar porphyry	246	8.2	<u>0.01</u>	0	187	612	-187	0	7.5	NAF
80477	40915	DR395	674.0	674.5	0.5	Mafic feldspar porphyry	142	8.4	0.01	0	169	551	-168	0	7.7	NAF
80442	40880	DR343	416.0	416.5	0.5	Mafic feldspar porphyry	146	8.4	<u>0.01</u>	0	72	235	-72	0	8.6	NAF
80424	40862	DR322	150.0	150.5	0.5	Mafic feldspar porphyry	315	8.5	0.77	24	79	3	-56	0	8.9	NAF
80458	40896	DR364	150.0	150.5	0.5	White mica schist	212	8.3	0.08	2	15	6	-13	0	4.7	NAF
80467	40905	DR379	575.0	575.5	0.5	White mica schist	245	8.7	0.05	2	11	7	-9	0	6.3	NAF
80488	40926	DR414	421.0	421.5	0.5	White mica schist	342	8.2	0.05	2	10	6	-8	0	7.2	NAF
80449	40887	DR355	501.0	501.5	0.5	White mica schist	146	8.2	0.29	9	9	1.0	0	6	3.5	PAF
80457	40895	DR356	263.0	263.5	0.5	Hanging wall slate (non sulphide)	307	7.8	1.07	33	455	14	-423	0	7.5	NAF
80453	40891	DR356	52.0	52.5	0.5	Hanging wall slate (Si Ab alt)	276	7.9	0.38	12	392	34	-380	0	7.9	NAF
80487	40925	DR414	337.0	337.5	0.5	Hanging wall slate (Si Ab alt)	331	8.4	<u>0.01</u>	0	190	621	-190	0	7.3	NAF
80437	40875	DR339	188.0	188.5	0.5	Hanging wall slate (Si Ab alt)	142	8.1	4.81	147	286	1.9	-139	0	8.1	NAF
80468	40906	DR379	584.0	584.5	0.5	Hanging wall slate (non sulphide)	225	8.9	0.89	27	159	6	-132	0	7.6	NAF
80428	40866	DR324	405.0	405.5	0.5	Hanging wall slate (non sulphide)	176	8.4	0.94	29	158	5	-129	0	8.1	NAF
80427	40865	DR324	300.0	300.5	0.5	Hanging wall slate (Si Ab alt)	325	8.5	0.42	13	81	6	-68	0	7.8	NAF
80483	40921	DR406	481.0	481.5	0.5	Hanging wall slate (non sulphide)	242	7.8	1.99	61	9	0.1	52	43	2.4	PAF

TABLE 2: Continued

MMG Sample ID	EGi Code	Hole No.	From (m)	To (m)	Interval (m)	Lithology	EC	Existing pH	Total %S	MPA	ANC	ANC/MPA Ratio	NAPP	NAG	NAGpH	ARD Class
80439	40877	DR339	248.0	248.5	0.5	Lode (mineralised waste)	145	8.2	2.05	63	237	4	-175	0	8.1	NAF
80478	40916	DR395	769.0	769.5	0.5	Lode (mineralised waste)	222	8.3	2.38	73	219	3	-146	0	7.8	NAF
80469	40907	DR379	631.0	631.5	0.5	Lode (mineralised waste)	312	8.1	13.94	427	398	0.9	28	0*	8.4	UC (NAF)
80489	40927	DR414	564.5	565.0	0.5	Lode (mineralised waste)	309	8.6	1.90	58	16	0.3	42	38	2.4	PAF
80429	40867	DR324	423.0	423.5	0.5	Lode (mineralised waste)	212	7.8	3.32	102	19	0.2	83	73	2.2	PAF
80484	40922	DR408	839.0	839.5	0.5	Lode (mineralised waste)	235	7.9	6.12	187	5	0.0	182	219*	2.0	PAF
80454	40892	DR356	181.0	181.5	0.5	Lode (mineralised waste)	186	7.4	10.46	320	34	0.1	286	348*	2.0	PAF
80450	40888	DR355	576.0	576.5	0.5	Lode (mineralised waste)	216	8.4	11.75	360	7	0.0	352	352*	2.0	PAF
80491	40929	DR417	58.0	58.5	0.5	Footwall slate	316	8.6	1.18	36	548	15	-512	0	7.7	NAF
80421	40859	DR315	284.0	284.5	0.5	Footwall slate	331	8.3	0.90	28	220	8	-193	0	7.8	NAF
80433	40871	DR331	197.0	197.5	0.5	Footwall slate	512	8.5	1.18	36	170	5	-134	0	8.3	NAF
80459	40897	DR364	278.0	278.5	0.5	Footwall slate	246	8.5	0.59	18	140	8	-122	0	7.8	NAF
80455	40893	DR356	215.0	215.5	0.5	Footwall slate	345	7.6	0.87	27	136	5	-109	0	7.8	NAF
80479	40917	DR395	932.0	932.5	0.5	Footwall slate	315	8.5	1.13	35	144	4	-109	0	7.6	NAF
80430	40868	DR324	456.0	456.5	0.5	Footwall slate	245	7.9	1.15	35	120	3	-84	0	9.3	NAF
80451	40889	DR355	636.0	636.5	0.5	Footwall slate	315	8.0	2.18	67	148	2.2	-82	0	7.5	NAF
80464	40902	DR373	638.0	638.5	0.5	Footwall slate	242	8.7	1.11	34	111	3	-77	0	8.9	NAF
80472	40910	DR388	478.0	478.5	0.5	Footwall slate	199	8.5	0.84	26	103	4	-77	0	7.6	NAF
80447	40885	DR346	449.0	449.5	0.5	Footwall slate	346	8.7	1.61	49	119	2.4	-70	0	7.6	NAF
80490	40928	DR414	599.5	600.0	0.5	Footwall slate	311	8.7	0.98	30	88	3	-58	0	7.8	NAF
80425	40863	DR322	288.0	288.5	0.5	Footwall slate	416	8.3	0.80	24	82	3	-57	0	7.9	NAF
80445	40883	DR345	351.0	351.5	0.5	Footwall slate	415	7.7	0.57	17	60	3	-42	0	7.8	NAF
80476	40914	DR393	698.0	698.5	0.5	Footwall slate	255	8.9	0.91	28	60	2.2	-32	0	7.6	NAF
80485	40923	DR408	889.0	889.5	0.5	Footwall slate	246	8.7	2.12	65	94	1.5	-30	0	7.5	NAF
80480	40918	DR405	212.0	212.5	0.5	Footwall slate	329	8.4	0.66	20	43	2.1	-23	0	7.9	NAF
80470	40908	DR379	671.0	671.5	0.5	Footwall slate	345	8.4	1.56	48	40	0.8	7	2	3.6	PAF
80438	40876	DR339	241.0	241.5	0.5	Footwall slate	117	8.9	1.66	51	11	0.2	40	37	2.4	PAF
80443	40881	DR343	521.0	521.5	0.5	Footwall slate	235	7.6	7.88	241	21	0.1	220	260*	2.0	PAF



TABLE 2: Continued

MMG Sample ID	EGi Code	Hole No.	From (m)	To (m)	Interval (m)	Lithology	EC	Existing pH	Total %S	MPA	ANC	ANC/MPA Ratio	NAPP	NAG	NAGpH	ARD Class
80462	40900	DR368	245.0	245.5	0.5	Foot wall limestone	203	8.5	0.77	24	516	22	-492	0	8.2	NAF
80426	40864	DR322	310.0	310.5	0.5	Foot wall limestone	239	8.2	0.88	27	467	17	-440	0	8.5	NAF
80422	40860	DR315	304.0	304.5	0.5	Foot wall limestone	216	8.1	0.68	21	456	22	-435	0	8.3	NAF
80460	40898	DR364	306.0	306.5	0.5	Foot wall limestone	197	8.6	0.89	27	462	17	-435	0	7.9	NAF
80436	40874	DR337	401.0	401.5	0.5	Foot wall limestone	315	8.2	1.06	32	462	14	-429	0	8.9	NAF
80434	40872	DR331	240.0	240.5	0.5	Foot wall limestone	146	8.2	1.06	32	451	14	-418	0	9.6	NAF
80492	40930	DR417	123.0	123.5	0.5	Foot wall limestone	321	8.5	0.97	30	444	15	-414	0	7.2	NAF
80473	40911	DR388	513.0	513.5	0.5	Foot wall limestone	227	8.6	1.22	37	446	12	-409	0	7.7	NAF
80456	40894	DR356	261.0	261.5	0.5	Foot wall limestone	329	8.4	1.87	57	435	8	-377	0	7.9	NAF
80461	40899	DR366	178.0	178.5	0.5	Foot wall limestone	176	8.7	1.32	40	385	10	-345	0	7.6	NAF
80440	40878	DR339	271.0	271.5	0.5	Foot wall limestone	129	7.9	1.28	39	363	9	-323	0	8.0	NAF
80465	40903	DR373	671.0	671.5	0.5	Foot wall limestone	403	8.6	0.83	25	302	12	-276	0	8.2	NAF
80431	40869	DR324	485.0	485.5	0.5	Foot wall limestone	335	8.6	1.53	47	307	7	-260	0	8.2	NAF
80444	40882	DR343	544.0	544.5	0.5	Foot wall limestone	246	7.8	0.82	25	229	9	-204	0	7.7	NAF
80435	40873	DR336	382.0	382.5	0.5	Foot wall limestone	235	8.3	0.71	22	215	10	-194	0	8.1	NAF
80446	40884	DR345	364.0	364.5	0.5	Foot wall limestone	329	8.6	0.85	26	199	8	-173	0	7.9	NAF
80471	40909	DR379	715.0	715.5	0.5	Foot wall limestone	332	8.3	0.92	28	192	7	-163	0	8.0	NAF
80452	40890	DR355	660.0	660.5	0.5	Foot wall limestone	429	7.8	0.39	12	152	13	-140	0	7.6	NAF
80481	40919	DR405	234.0	234.5	0.5	Foot wall limestone	276	7.6	0.10	3	127	41	-123	0	7.2	NAF
80486	40924	DR412	36.0	36.5	0.5	Foot wall limestone	196	8.3	1.69	52	107	2.1	-55	0	7.6	NAF

**KEY**

Existing pH = pH of 1:2 extract

EC = Electrical Conductivity of 1:2 extract (µS/cm)

MPA = Maximum Potential Acidity (kg H<sub>2</sub>SO<sub>4</sub>/t)

ANC = Acid Neutralising Capacity (kg H<sub>2</sub>SO<sub>4</sub>/t)

NAPP = Net Acid Producing Potential (kg H<sub>2</sub>SO<sub>4</sub>/t)

NAG = Net Acid Generation capacity to pH 7.0 (kg H<sub>2</sub>SO<sub>4</sub>/t)

NAGpH = pH of NAG liquor

\* note: NAG values with asterisk are from sequential NAG tests

NAF = Non-Acid Forming

PAF = Potentially Acid Forming

UC = Uncertain Classification

(likely classification given in brackets)

**TABLE 3: Speciation of sulphur forms in Dugald River waste rock**

MMG Sample ID	EGi Code	Hole No.	From (m)	To (m)	Lithology	SESL Lab Total-S (%S)	ALS Lab				ARD Class
							Total-S (%S)	Sulphate-S (%S)	Sulphide-S (%S)	Cr Reducible-S (%S)	
80429	40867	DR324	423.0	423.5	Lode (mineralised Waste)	3.32	3.95	0.05	3.90	3.41	PAF
80437	40875	DR339	188.0	188.5	Hanging Wall Slate	4.81	4.47	0.29	4.18	4.33	NAF
80438	40876	DR339	241.0	241.5	Footwall Slate	1.66	1.62	0.16	1.46	1.64	PAF
80443	40881	DR343	521.0	521.5	Footwall Slate	7.88	7.67	1.46	6.21	6.81	PAF
80447	40885	DR346	449.0	449.5	Footwall Slate	1.61	2.11	0.07	2.04	1.88	NAF
80450	40888	DR355	576.0	576.5	Lode (mineralised Waste)	11.75	11.5	1.64	9.86	8.94	PAF
80451	40889	DR355	636.0	636.5	Footwall Slate	2.18	2.13	0.17	1.96	1.76	NAF
80454	40892	DR356	181.0	181.5	Lode (mineralised Waste)	10.46	9.48	1.42	8.06	8.42	PAF
80469	40907	DR379	631.0	631.5	Lode (mineralised Waste)	13.94	21.1	0.28	20.82	19.7	UC (NAF)
80470	40908	DR379	671.0	671.5	Footwall Slate	1.56	1.55	0.12	1.43	1.32	PAF
80483	40921	DR406	481.0	481.5	Hanging Wall Slate	1.99	2.16	0.13	2.03	1.92	PAF
80484	40922	DR408	839.0	839.5	Lode (mineralised Waste)	6.12	6.55	2.31	4.24	5.97	PAF
80485	40923	DR408	889.0	889.5	Footwall Slate	2.12	1.86	0.09	1.77	1.88	NAF
80486	40924	DR412	36.0	36.5	Footwall Limestone	1.69	1.72	0.02	1.70	1.68	NAF
80489	40927	DR414	564.5	565.0	Lode (mineralised Waste)	1.90	2.03	0.22	1.81	1.64	PAF
<p><b>KEY</b></p> <p>Total-S: by Leco furnace  Sulphate-S: by HCl leach method  Sulphide-S: by difference of total-S and SO4-S  Cr-Reducible-S: by reaction with hot acidic CrCl2</p> <p>NAF = Non-Acid Forming  PAF = Potentially Acid Forming  UC = Uncertain Classification  <i>(likely classification given in brackets)</i></p>											

**TABLE 4: Elemental composition of Dugald River waste rock**

MMG Code	80466	80448	80442	80424	80467	80449	80428	80483	80437	80478	80454	80430	80438	80436	80486	
EGi Code	40904	40886	40880	40862	40905	40887	40866	40921	40875	40916	40892	40868	40876	40874	40924	
Hole	DR379	DR355	DR343	DR322	DR379	DR355	DR324	DR406	DR339	DR395	DR356	DR324	DR339	DR337	DR412	
From (m)	531.0	435.0	416.0	150.0	575.0	501.0	405.0	481.0	188.0	769.0	181.0	456.0	241.0	401.0	36.0	
To (m)	531.5	435.5	416.5	150.5	575.5	501.5	405.5	481.5	188.5	769.5	181.5	456.5	241.5	401.5	36.5	
Lithology	Calc Silicate	Calc Silicate	Mafic Feldspar Porphyry	Mafic Feldspar Porphyry	White Mica Schist	White Mica Schist	Hanging Wall Slate	Hanging Wall Slate	Hanging Wall Slate	Lode Waste	Lode Waste	Footwall Slate	Footwall Slate	Footwall Limestone	Footwall Limestone	
Parameter	NAF	NAF	NAF	NAF	NAF	PAF	NAF	PAF	NAF	NAF	PAF	NAF	PAF	NAF	NAF	
S	%	0.53	2.52	0.01	0.65	0.05	0.26	0.93	1.51	4.12	2.32	8.22	0.94	1.34	1.48	2.04
Al	%	6.16	5.34	7.12	7.41	11.05	8.69	6.3	7.61	4.33	6.58	5.65	5.46	7.17	3.19	5.66
Ca	%	3.59	9.09	2.29	2.09	0.35	0.25	4.48	0.39	9.01	9.21	0.14	4.86	0.82	10.55	3.52
Fe	%	3.84	5.63	10.15	6.05	4.85	0.86	2.41	3	8.07	5.36	7.26	2.68	2.31	1.85	3.52
K	%	2.64	4.16	2.39	1.41	4.09	4.34	4.75	5.02	2.86	5.4	4.49	3.93	4.93	1.12	2.26
Mg	%	0.96	1.14	2.48	4.38	1.28	0.61	2.08	0.78	4.14	0.98	0.35	1.19	0.96	4.84	3.11
Na	%	0.57	0.19	2.79	2.28	0.34	0.25	0.2	0.59	0.17	0.28	0.13	0.28	0.79	0.77	0.3
Ti	%	0.332	0.222	0.747	0.295	0.54	0.356	0.198	0.243	0.11	0.313	0.124	0.232	0.155	0.078	0.169
As	mg/kg	1.3	0.4	1.5	4.9	3.7	0.7	234	72.3	11	572	167.5	80.2	683	19	1.2
Ba	mg/kg	510	840	370	180	850	1030	500	1300	480	350	80	750	1110	540	360
Be	mg/kg	2.5	1.1	1.06	4.26	2.44	5.43	1.77	1.84	1.38	4.23	1.66	1.91	2.79	1.04	2.23
Bi	mg/kg	0.22	0.08	0.08	0.06	0.1	0.24	0.33	0.55	0.88	0.08	3.55	0.61	0.26	0.29	0.32
Cd	mg/kg	0.17	<u>0.02</u>	<u>0.02</u>	<u>0.02</u>	0.08	<u>0.02</u>	0.19	0.13	0.06	0.24	62.4	0.68	0.08	1.74	0.08
Co	mg/kg	14.2	17	21.2	23.8	14	3.3	6.9	11.1	8.5	12	44.4	12.5	12.8	6.1	25.5
Cr	mg/kg	47	37	17	51	77	57	37	78	35	49	44	38	49	20	36
Cu	mg/kg	159	2	9.1	4.2	25.3	8.5	24.1	44.8	324	25.8	39.9	52.4	33.4	13.2	162.5
Ga	mg/kg	19.2	15	21.6	24.1	29.3	27.9	17.9	21.2	11.9	14.85	15.05	15.95	21.8	8.36	16.5
Hg	mg/kg	<u>0.005</u>	<u>0.005</u>	<u>0.005</u>	0.017	<u>0.005</u>	<u>0.005</u>	0.018	0.012	0.009	<u>0.005</u>	1.055	0.009	0.006	0.072	<u>0.005</u>
In	mg/kg	0.079	0.041	0.063	0.025	0.077	0.061	0.026	0.02	0.006	0.012	0.144	0.053	0.01	0.042	0.012
La	mg/kg	84	31.4	42	132	46.9	66.6	45.5	68.5	23.7	34.4	19.9	31	81.2	27.1	81.8
Li	mg/kg	31.8	25.7	40.8	43.1	42.2	57.1	31.3	21.2	32.8	51.3	34.4	64.8	46.8	62.1	54.2
Mn	mg/kg	989	2100	824	1450	875	289	3380	336	5190	13600	1060	1560	1780	649	1020
Mo	mg/kg	1.26	3.52	0.84	0.4	0.54	0.59	7.7	4.67	8.92	5.48	8.4	4.11	8.5	4.07	3.22
Nb	mg/kg	11.8	7.1	6.6	10.9	17.4	7.7	7.3	7	3.9	10.2	3.1	9	5.7	2.1	4.3
Ni	mg/kg	21.4	22.6	35.5	31.7	40.7	27.8	17.7	43.1	82.9	32.3	30.3	21.6	25.3	14.8	36.9
P	mg/kg	790	470	680	650	850	650	830	620	740	1490	620	1150	1020	370	1020
Pb	mg/kg	4.8	5.1	0.7	3.2	5.7	5.8	22.4	39.6	17.6	51.7	433	23.5	73.4	73.3	6.7
Sb	mg/kg	0.52	0.53	0.74	0.46	0.27	0.6	3.48	2.4	1.04	0.42	8.69	0.51	0.26	1.62	0.79
Se	mg/kg	2	2	3	2	2	2	2	4	5	3	5	2	2	1	2
Sn	mg/kg	3.8	2.8	3.7	7.1	3.5	4.7	1.6	1.3	1.3	0.8	1.7	4.7	1.6	1.2	0.6
Sr	mg/kg	119.5	132.5	87.3	36.5	31.1	46.8	77.4	123	44.6	1405	48	156.5	108.5	236	34.4
Th	mg/kg	19.4	11.7	2.2	16.1	20.7	19.1	13.4	18.8	8.2	9.4	13.1	12.4	19.5	7.1	12.7
U	mg/kg	4.7	6.9	0.6	6.2	5.1	19	7	12.5	8.9	15.2	8.6	5.9	11.1	4.3	6.4
V	mg/kg	80	84	309	88	104	82	90	117	79	103	77	57	84	35	62
Zn	mg/kg	125	39	28	27	61	23	149	87	31	165	4.14%	463	38	520	17

\* Underlined values indicate concentration below the analytical detection limit.

**TABLE 5: Geochemical abundance indices for Dugald River waste rock**

MMG Code	80466	80448	80442	80424	80467	80449	80428	80483	80437	80478	80454	80430	80438	80436	80486	Median Soil Content
EGi Code	40904	40886	40880	40862	40905	40887	40866	40921	40875	40916	40892	40868	40876	40874	40924	
Lithology	Calc Silicate	Calc Silicate	Mafic Feldspar Porphyry	Mafic Feldspar Porphyry	White Mica Schist	White Mica Schist	Hanging Wall Slate	Hanging Wall Slate	Hanging Wall Slate	Lode Waste	Lode Waste	Footwall Slate	Footwall Slate	Footwall Limestone	Footwall Limestone	
Parameter	NAF	NAF	NAF	NAF	NAF	PAF	NAF	PAF	NAF	NAF	PAF	NAF	PAF	NAF	NAF	
S	2	4	0	2	0	1	3	3	5	4	6	3	3	3	4	0.07 %
Al	0	0	0	0	0	0	0	0	0	0	0	0	0	0	0	7.1 %
Ca	0	2	0	0	0	0	0	0	2	2	0	1	0	2	0	1.5 %
Fe	0	0	0	0	0	0	0	0	0	0	0	0	0	0	0	4 %
K	0	0	0	0	0	1	1	1	0	1	1	0	1	0	0	1.4 %
Mg	0	0	1	2	0	0	1	0	2	0	0	0	0	2	2	0.5 %
Na	0	0	1	1	0	0	0	0	0	0	0	0	0	0	0	0.5 %
Ti	0	0	0	0	0	0	0	0	0	0	0	0	0	0	0	0.5 %
As	0	0	0	0	0	0	4	3	0	5	4	3	6	1	0	6 mg/kg
Ba	0	0	0	0	0	0	0	0	0	0	0	0	0	0	0	500 mg/kg
Be	0	0	0	0	0	0	0	0	0	0	0	0	0	0	0	6 mg/kg
Bi	0	0	0	0	0	0	0	0	1	0	3	1	0	0	0	0.2 mg/kg
Cd	0	0	0	0	0	0	0	0	0	0	6	0	0	1	0	0.4 mg/kg
Co	0	0	0	0	0	0	0	0	0	0	1	0	0	0	1	8 mg/kg
Cr	0	0	0	0	0	0	0	0	0	0	0	0	0	0	0	70 mg/kg
Cu	1	0	0	0	0	0	0	0	2	0	0	0	0	0	1	30 mg/kg
Ga	0	0	0	0	0	0	0	0	0	0	0	0	0	0	0	20 mg/kg
Hg	0	0	0	0	0	0	0	0	0	0	3	0	0	0	0	0.06 mg/kg
In	0	0	0	0	0	0	0	0	0	0	0	0	0	0	0	1 mg/kg
La	0	0	0	1	0	0	0	0	0	0	0	0	0	0	0	40 mg/kg
Li	0	0	0	0	0	0	0	0	0	0	0	0	0	0	0	25 mg/kg
Mn	0	0	0	0	0	0	1	0	1	3	0	0	0	0	0	1000 mg/kg
Mo	0	0	0	0	0	0	1	0	1	0	1	0	1	0	0	2 mg/kg
Nb	0	0	0	0	0	0	0	0	0	0	0	0	0	0	0	10 mg/kg
Ni	0	0	0	0	0	0	0	0	0	0	0	0	0	0	0	50 mg/kg
P	0	0	0	0	0	0	0	0	0	0	0	0	0	0	0	800 mg/kg
Pb	0	0	0	0	0	0	0	0	0	0	3	0	0	0	0	35 mg/kg
Sb	0	0	0	0	0	0	0	0	0	0	0	0	0	0	0	5 mg/kg
Se	1	1	2	1	1	1	1	2	3	2	3	1	1	0	1	0.4 mg/kg
Sn	0	0	0	0	0	0	0	0	0	0	0	0	0	0	0	4 mg/kg
Sr	0	0	0	0	0	0	0	0	0	1	0	0	0	0	0	250 mg/kg
Th	0	0	0	0	0	0	0	0	0	0	0	0	0	0	0	9 mg/kg
U	0	1	0	1	0	2	1	2	1	2	1	0	1	0	1	2 mg/kg
V	0	0	1	0	0	0	0	0	0	0	0	0	0	0	0	90 mg/kg
Zn	0	0	0	0	0	0	0	0	0	0	6	1	0	1	0	90 mg/kg

# Median soil data from:  
Bowen, H.J.M. (1979) Environmental Chemistry of the Elements. Academic Press, London.  
Berkman, D.A. (1976) Field Geologists' Manual, The Australian Institute of Mining and Metallurgy, Vic.

\* Geochemical Abundance Indices (GAI)  
GAI=0 represents <3 times median soil content  
GAI=1 represents 3 to 6 times  
GAI=2 represents 6 to 12 times  
GAI=3 represents 12 to 24 times  
GAI=4 represents 24 to 48 times  
GAI=5 represents 48 to 96 times  
GAI=6 represents more than 96 times

**TABLE 6: Water extractable elements in Dugald River waste rock**

MMG Code	80466	80448	80442	80424	80467	80449	80428	80483	80437	80478	80454	80430	80438	80436	80486	Blank
EGi Code	40904	40886	40880	40862	40905	40887	40866	40921	40875	40916	40892	40868	40876	40874	40924	
Hole	DR379	DR355	DR343	DR322	DR379	DR355	DR324	DR406	DR339	DR395	DR356	DR324	DR339	DR337	DR412	
From (m)	531.0	435.0	416.0	150.0	575.0	501.0	405.0	481.0	188.0	769.0	181.0	456.0	241.0	401.0	36.0	
To (m)	531.5	435.5	416.5	150.5	575.5	501.5	405.5	481.5	188.5	769.5	181.5	456.5	241.5	401.5	36.5	
Lithology	Calc Silicate	Calc Silicate	Mafic Feldspar Porphyry	Mafic Feldspar Porphyry	White Mica Schist	White Mica Schist	Hanging Wall Slate	Hanging Wall Slate	Hanging Wall Slate	Lode Waste	Lode Waste	Footwall Slate	Footwall Slate	Footwall Limestone	Footwall Limestone	
Parameter	NAF	NAF	NAF	NAF	NAF	PAF	NAF	PAF	NAF	NAF	PAF	NAF	PAF	NAF	NAF	
pH	7.7	8.5	7.4	8.4	8.3	8.1	7.9	7.9	7.8	8.4	8.2	8.5	8.3	8.2	8.2	5.9
EC μS/cm	81	145	213	146	95	86	83	142	107	167	123	115	111	92	107	1
Ag mg/L	<0.001	<0.001	<0.001	<0.001	<0.001	<0.001	<0.001	<0.001	<0.001	<0.001	<0.001	<0.001	<0.001	<0.001	<0.001	<0.001
Al mg/L	0.2	0.1	0.3	0.5	0.4	0.6	0.3	0.04	0.2	0.2	0.02	0.3	0.3	0.2	0.2	<0.01
As mg/L	<0.001	<0.001	<0.001	<0.001	0.004	<0.001	0.006	<0.001	0.002	0.02	<0.001	0.003	0.01	0.002	0.002	<0.001
B mg/L	<0.05	<0.05	<0.05	<0.05	<0.05	<0.05	<0.05	<0.05	<0.05	<0.05	<0.05	<0.05	<0.05	<0.05	<0.05	<0.05
Ba mg/L	0.003	0.007	0.02	0.002	0.04	0.005	0.02	0.03	0.008	0.3	0.02	0.03	0.02	0.04	0.02	0.002
Be mg/L	<0.001	<0.001	<0.001	<0.001	<0.001	<0.001	<0.001	<0.001	<0.001	<0.001	<0.001	<0.001	<0.001	<0.001	<0.001	<0.001
Ca mg/L	48	221	5	6	4	5	8	22	6	9	<1	6	5	6	11	<1
Cd mg/L	<0.0001	<0.0001	<0.0001	<0.0001	<0.0001	<0.0001	<0.0001	<0.0001	<0.0001	<0.0001	<0.0001	<0.0001	<0.0001	<0.0001	<0.0001	<0.0001
Cl mg/L	1	2	1	2	2	<1	2	2	2	2	2	1	2	2	2	1
Co mg/L	<0.001	<0.001	<0.001	<0.001	<0.001	<0.001	<0.001	<0.001	<0.001	<0.001	<0.001	<0.001	<0.001	<0.001	<0.001	<0.001
Cr mg/L	<0.001	<0.001	<0.001	<0.001	<0.001	<0.001	<0.001	<0.001	<0.001	<0.001	<0.001	<0.001	<0.001	<0.001	<0.001	<0.001
Cu mg/L	0.001	0.002	<0.001	0.003	0.002	0.002	0.002	0.001	<0.001	0.003	0.002	0.002	0.003	0.002	0.001	0.004
F mg/L	<0.1	<0.1	<0.1	0.1	<0.1	0.2	<0.1	<0.1	0.1	0.2	<0.1	0.1	<0.1	<0.1	<0.1	<0.1
Fe mg/L	<0.05	0.1	<0.05	0.3	0.1	0.06	<0.05	<0.05	<0.05	<0.05	0.3	<0.05	<0.05	<0.05	<0.05	<0.05
Hg mg/L	<0.0001	<0.0001	<0.0001	<0.0001	<0.0001	<0.0001	<0.0001	<0.0001	<0.0001	<0.0001	<0.0001	<0.0001	<0.0001	<0.0001	<0.0001	<0.0001
K mg/L	3	2	4	1	3	3	3	3	3	1	<1	2	2	2	3	<1
Mg mg/L	<1	<1	<1	2	<1	<1	2	2	<1	<1	<1	<1	<1	2	1	<1
Mn mg/L	0.007	0.04	0.002	0.02	0.02	0.01	0.02	0.2	0.01	0.04	0.03	0.006	0.01	0.002	0.005	<0.001
Mo mg/L	<0.001	0.004	<0.001	<0.001	<0.001	<0.001	<0.001	<0.001	0.002	<0.001	<0.001	<0.001	<0.001	<0.001	0.001	<0.001
Na mg/L	2	<1	<1	1	1	<1	1	1	2	<1	<1	2	2	1	2	<1
Ni mg/L	<0.001	<0.001	<0.001	<0.001	<0.001	<0.001	<0.001	0.003	<0.001	<0.001	0.006	<0.001	<0.001	<0.001	<0.001	<0.001
P mg/L	<1	<1	<1	<1	<1	<1	<1	<1	<1	<1	<1	<1	<1	<1	<1	<1
Pb mg/L	<0.001	<0.001	<0.001	<0.001	<0.001	<0.001	<0.001	<0.001	<0.001	<0.001	0.004	<0.001	<0.001	<0.001	<0.001	<0.001
Sb mg/L	<0.001	<0.001	<0.001	<0.001	<0.001	<0.001	0.002	<0.001	0.002	<0.001	0.001	<0.001	<0.001	0.003	<0.001	<0.001
Se mg/L	<0.01	<0.01	<0.01	<0.01	<0.01	<0.01	<0.01	<0.01	<0.01	<0.01	<0.01	<0.01	<0.01	<0.01	<0.01	<0.01
Si mg/L	0.8	0.4	0.9	0.7	1.0	1.2	0.8	0.4	0.9	0.6	0.2	1.2	1.0	0.8	1.2	<0.05
Sn mg/L	<0.001	<0.001	<0.001	<0.001	<0.001	<0.001	<0.001	<0.001	<0.001	<0.001	<0.001	<0.001	<0.001	<0.001	<0.001	<0.001
SO4 mg/L	113	549	<1	4	<1	2	11	49	5	6	5	2	4	3	20	<1
Sr mg/L	0.2	0.4	0.008	0.006	0.02	0.007	0.03	0.1	0.02	0.09	0.004	0.04	0.01	0.06	0.02	<0.001
Th mg/L	<0.001	<0.001	<0.001	<0.001	<0.001	<0.001	<0.001	<0.001	<0.001	<0.001	<0.001	<0.001	<0.001	<0.001	<0.001	<0.001
U mg/L	<0.001	<0.001	<0.001	<0.001	<0.001	<0.001	<0.001	<0.001	<0.001	<0.001	<0.001	<0.001	<0.001	<0.001	<0.001	<0.001
Zn mg/L	<0.005	<0.005	<0.005	0.011	<0.005	<0.005	<0.005	<0.005	<0.005	<0.005	0.4	<0.005	0.009	<0.005	<0.005	<0.005

**TABLE 7: Acid extractable elements in Dugald River waste rock**

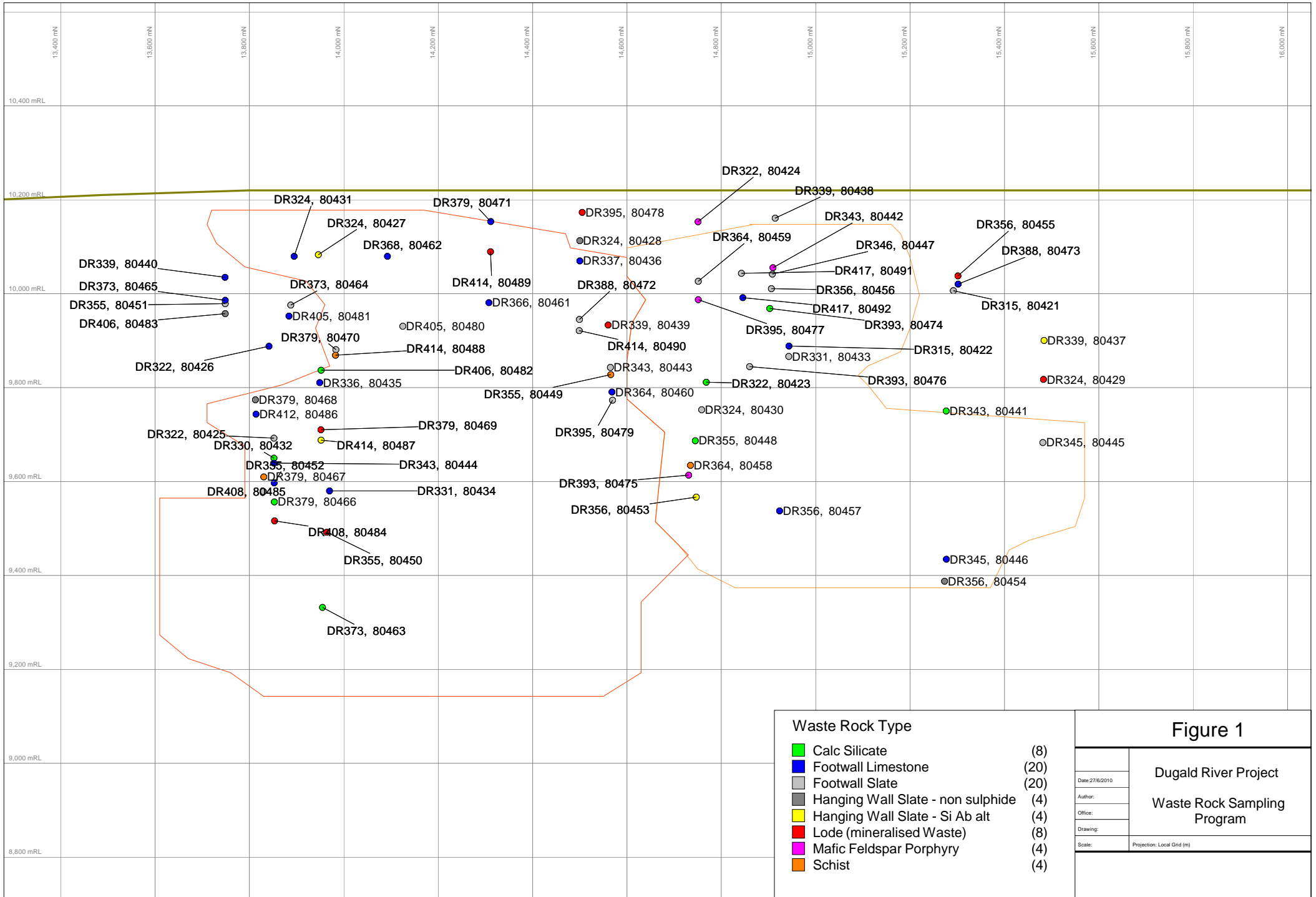
MMG Code	80466	80448	80442	80424	80467	80449	80428	80483	80437	80478	80454	80430	80438	80436	80486	Blank
EGi Code	40904	40886	40880	40862	40905	40887	40866	40921	40875	40916	40892	40868	40876	40874	40924	
Hole	DR379	DR355	DR343	DR322	DR379	DR355	DR324	DR406	DR339	DR395	DR356	DR324	DR339	DR337	DR412	
From (m)	531.0	435.0	416.0	150.0	575.0	501.0	405.0	481.0	188.0	769.0	181.0	456.0	241.0	401.0	36.0	
To (m)	531.5	435.5	416.5	150.5	575.5	501.5	405.5	481.5	188.5	769.5	181.5	456.5	241.5	401.5	36.5	
Lithology	Calc Silicate	Calc Silicate	Mafic Feldspar Porphyry	Mafic Feldspar Porphyry	White Mica Schist	White Mica Schist	Hanging Wall Slate	Hanging Wall Slate	Hanging Wall Slate	Lode Waste	Lode Waste	Footwall Slate	Footwall Slate	Footwall Limestone	Footwall Limestone	
Parameter	NAF	NAF	NAF	NAF	NAF	PAF	NAF	PAF	NAF	NAF	PAF	NAF	PAF	NAF	NAF	
pH	1.5	5.4	1.8	1.9	1.4	1.6	1.9	1.5	3.3	5.3	1.5	2.1	1.7	5.3	1.6	1.61
EC $\mu$ S/cm	18,110	2,410	10,510	11,550	21,020	21,280	9,230	20,620	3,220	2,680	22,210	5,520	21,210	3,510	13,390	23,110
Ag mg/L	<0.001	<0.001	<0.001	<0.001	<0.001	<0.001	<0.001	<0.001	<0.001	<0.001	<0.001	<0.001	<0.001	<0.001	<0.001	<0.001
Al mg/L	22	0.6	20	13	10	11	2	8	3	0.5	3	8	11	0.3	8	0.05
As mg/L	0.008	0.001	0.02	0.01	0.02	0.007	0.03	0.06	0.01	0.03	0.006	0.01	0.04	0.003	0.007	0.01
B mg/L	<0.05	<0.05	<0.05	<0.05	<0.05	<0.05	<0.05	<0.05	<0.05	<0.05	<0.05	<0.05	<0.05	<0.05	<0.05	<0.05
Ba mg/L	0.05	0.02	0.14	0.05	0.03	0.06	0.02	0.03	0.07	0.04	0.02	0.05	0.03	0.07	0.03	0.001
Be mg/L	0.005	0.001	0.001	0.008	0.002	0.01	0.001	0.004	0.005	0.002	<0.001	0.008	0.004	<0.001	0.009	<0.001
Ca mg/L	393	639	874	709	96	84	759	164	653	652	20	707	96	724	782	<1
Cd mg/L	<0.0001	<0.0001	0.0001	<0.0001	0.0004	<0.0001	0.0002	0.0003	0.0001	0.0003	0.005	0.0004	0.0002	0.0004	0.0003	<0.0001
Cl mg/L	<1	1	2	3	<1	<1	<1	<1	2	4	<1	1	<1	2	<1	<1
Co mg/L	0.007	0.004	0.02	0.01	0.02	0.004	0.006	0.03	0.004	0.004	<0.001	0.007	0.004	0.003	0.03	<0.001
Cr mg/L	0.04	0.002	0.01	0.03	0.02	0.02	0.01	0.08	0.03	0.004	0.004	0.03	0.04	0.003	0.03	0.005
Cu mg/L	0.04	0.004	0.01	0.08	0.03	0.01	0.01	0.03	0.007	0.002	0.002	0.03	0.02	0.03	0.09	0.01
F mg/L	1.2	0.3	0.8	0.5	3.7	<5.9	0.4	1.8	0.8	0.9	0.7	1.0	3.3	0.3	0.9	<0.1
Fe mg/L	23	4	39	59	21	11	60	25	23	11	17	19	15	14	28	1
Hg mg/L	<0.0001	<0.0001	<0.0001	<0.0001	<0.0001	<0.0001	<0.0001	<0.0001	<0.0001	<0.0001	<0.0001	<0.0001	<0.0001	<0.0001	<0.0001	<0.0001
K mg/L	8	2	32	9	7	10	5	6	7	2	1	11	7	5	13	<1
Mg mg/L	10	6	32	261	7	6	260	11	113	17	2	15	6	225	109	<1
Mn mg/L	4	31	11	20	1	1	58	4	40	137	3	34	2	6	17	0.001
Mo mg/L	0.003	0.003	<0.001	0.001	<0.001	<0.001	0.002	0.005	0.003	0.003	<0.001	0.002	0.003	<0.001	0.003	<0.001
Na mg/L	14	1	2	2	2	<1	1	2	2	1	<1	4	3	1	2	<1
Ni mg/L	0.01	0.002	0.03	0.02	0.02	0.03	0.01	0.1	0.02	0.009	0.01	0.02	0.02	0.01	0.06	<0.001
P mg/L	16	<1	27	9	27	20	4	11	8	<1	3	12	23	<1	18	<1
Pb mg/L	0.01	<0.001	0.005	0.02	0.06	0.04	0.05	0.1	0.05	0.004	0.3	0.04	0.4	0.03	0.03	0.001
Sb mg/L	<0.001	<0.001	<0.001	<0.001	<0.001	0.001	0.002	0.003	0.002	<0.001	0.002	<0.001	<0.001	0.007	<0.001	<0.001
Se mg/L	<0.01	<0.01	<0.01	<0.01	<0.01	<0.01	<0.01	<0.01	<0.01	<0.01	<0.01	<0.01	<0.01	<0.01	<0.01	<0.01
Si mg/L	16	2	27	12	13	12	2	8	3	1	2	8	12	1	10	<0.50
Sn mg/L	<0.001	<0.001	<0.001	<0.001	<0.001	<0.001	<0.001	<0.001	<0.001	<0.001	<0.001	<0.001	<0.001	<0.001	<0.001	<0.001
SO4 mg/L	4880	2640	3870	4400	4830	4770	4270	4950	2420	3120	4770	2600	4930	2610	4370	4870
Sr mg/L	0.3	0.5	0.4	0.08	0.09	0.05	0.3	0.3	0.2	3.2	0.07	0.4	0.07	1.2	0.3	<0.001
Th mg/L	0.05	<0.001	0.002	0.04	0.03	0.06	0.02	0.03	0.004	<0.001	0.006	0.02	0.13	<0.001	0.009	<0.001
U mg/L	0.009	0.004	<0.001	0.01	0.02	0.05	0.004	0.02	0.008	0.001	0.003	0.007	0.05	0.001	0.04	<0.001
Zn mg/L	0.05	0.03	0.09	0.1	0.2	0.09	0.2	0.2	0.09	0.07	5.8	0.3	0.2	0.2	0.1	<0.005

**TABLE 8: Peroxide extractable elements in Dugald River waste rock**

MMG Code	80466	80448	80442	80424	80467	80449	80428	80483	80437	80478	80454	80430	80438	80436	80486
EGi Code	40904	40886	40880	40862	40905	40887	40866	40921	40875	40916	40892	40868	40876	40874	40924
Hole	DR379	DR355	DR343	DR322	DR379	DR355	DR324	DR406	DR339	DR395	DR356	DR324	DR339	DR337	DR412
From (m)	531.0	435.0	416.0	150.0	575.0	501.0	405.0	481.0	188.0	769.0	181.0	456.0	241.0	401.0	36.0
To (m)	531.5	435.5	416.5	150.5	575.5	501.5	405.5	481.5	188.5	769.5	181.5	456.5	241.5	401.5	36.5
Lithology	Calc Silicate	Calc Silicate	Mafic Feldspar Porphyry	Mafic Feldspar Porphyry	White Mica Schist	White Mica Schist	Hanging Wall Slate	Hanging Wall Slate	Hanging Wall Slate	Lode Waste	Lode Waste	Footwall Slate	Footwall Slate	Footwall Limestone	Footwall Limestone
Parameter	NAF	NAF	NAF	NAF	NAF	PAF	NAF	PAF	NAF	NAF	PAF	NAF	PAF	NAF	NAF
NAGpH	8.5	9.2	8.5	8.8	6.2	3.5	8.2	2.4	8.3	7.9	2.3	8.9	2.4	8.7	7.6
Ag mg/L	<0.001	<0.001	<0.001	<0.001	<0.001	<0.001	<0.001	<0.001	<0.001	<0.001	0.003	<0.001	<0.001	<0.001	<0.001
Al mg/L	1.31	1.48	1.84	0.11	0.53	6.91	0.15	6.29	0.07	0.31	5.87	0.44	11.4	0.04	0.92
As mg/L	0.004	<0.001	0.004	<0.001	0.006	<0.001	<0.001	0.016	<0.001	0.001	0.02	0.001	0.146	<0.001	0.002
B mg/L	0.06	0.06	<0.05	0.09	<0.05	<0.05	<0.05	<0.05	<0.05	<0.05	<0.05	<0.05	<0.05	0.3	<0.05
Ba mg/L	0.007	0.01	0.011	0.017	0.063	0.152	0.042	0.138	0.037	0.055	0.101	0.081	0.188	0.108	0.063
Be mg/L	<0.001	<0.001	<0.001	<0.001	<0.001	0.005	<0.001	0.002	<0.001	<0.001	0.001	<0.001	0.004	<0.001	<0.001
Ca mg/L	63	384	6	40	12	26	94	45	271	101	3	78	31	70	132
Cd mg/L	0.0107	<0.0001	<0.0001	<0.0001	<0.0001	0.0003	<0.0001	0.0014	<0.0001	<0.0001	0.675	<0.0001	0.0013	<0.0001	<0.0001
Cl mg/L	<1	<1	<1	1	<1	<1	<1	<1	3	<1	<1	<1	<1	<1	<1
Co mg/L	0.005	<0.001	0.003	<0.001	0.001	0.038	<0.001	0.166	<0.001	<0.001	0.308	<0.001	0.164	<0.001	0.003
Cr mg/L	0.005	0.004	0.002	0.007	0.004	0.008	0.002	0.008	<0.001	0.002	0.009	0.003	0.006	0.002	0.002
Cu mg/L	0.018	0.002	0.019	0.006	0.008	0.118	0.002	0.632	0.003	0.003	0.546	0.002	0.523	0.002	0.019
F mg/L	<0.1	0.2	<0.1	0.2	0.1	1.8	0.3	0.3	0.4	1	0.3	0.6	0.5	0.2	0.1
Fe mg/L	5.41	0.09	0.86	0.12	0.72	0.21	0.11	52.6	0.06	0.1	184	<0.05	33.6	0.06	1.75
Hg mg/L	<0.0001	<0.0001	<0.0001	<0.0001	0.0001	<0.0001	<0.0001	<0.0001	<0.0001	<0.0001	<0.0001	<0.0001	<0.0001	<0.0001	<0.0001
K mg/L	9	5	34	11	9	15	6	8	11	3	6	8	12	8	8
Mg mg/L	<1	<1	<1	<1	2	2	4	5	8	<1	2	<1	5	2	1
Mn mg/L	0.158	0.003	0.031	0.007	0.077	0.416	0.024	1.11	0.028	0.059	8.24	0.007	1.29	0.002	0.039
Mo mg/L	0.008	0.057	<0.001	0.004	0.008	0.009	0.048	<0.001	0.041	0.015	0.001	0.042	<0.001	0.049	0.031
Na mg/L	2	<1	1	2	<1	<1	<1	1	1	<1	<1	1	3	2	1
Ni mg/L	0.005	<0.001	0.004	<0.001	0.001	0.339	<0.001	0.598	<0.001	<0.001	0.329	<0.001	0.274	<0.001	0.009
P mg/L	<1	<1	<1	<1	<1	<1	<1	<1	<1	<1	<1	<1	<1	<1	<1
Pb mg/L	0.048	<0.001	0.008	0.002	0.003	0.012	<0.001	0.179	<0.001	<0.001	2.56	<0.001	0.364	<0.001	0.005
Sb mg/L	<0.001	<0.001	<0.001	<0.001	<0.001	<0.001	0.002	<0.001	<0.001	<0.001	0.002	<0.001	<0.001	0.004	<0.001
Se mg/L	<0.01	<0.01	<0.01	<0.01	<0.01	<0.01	<0.01	0.02	0.02	<0.01	0.03	<0.01	<0.01	<0.01	<0.01
Si mg/L	4.91	3.45	6.69	5.06	2.47	10.3	1.18	7.77	0.45	0.93	6.93	1.65	14.5	2.96	1.33
Sn mg/L	<0.001	<0.001	<0.001	<0.001	<0.001	<0.001	<0.001	<0.001	<0.001	<0.001	<0.001	<0.001	<0.001	<0.001	<0.001
SO4 mg/L	181	826	10	98	14	129	224	626	652	247	1720	190	540	178	321
Sr mg/L	0.153	0.667	0.008	0.012	0.016	0.041	0.063	0.106	0.055	0.347	0.01	0.079	0.054	0.223	0.078
Th mg/L	<0.001	<0.001	<0.001	<0.001	<0.001	<0.001	<0.001	0.021	<0.001	<0.001	0.013	<0.001	0.058	<0.001	<0.001
U mg/L	<0.001	<0.001	0.002	<0.001	<0.001	0.019	<0.001	0.027	<0.001	<0.001	0.019	<0.001	0.099	<0.001	<0.001
Zn mg/L	6.19	<0.005	0.024	0.01	0.028	0.164	0.016	0.928	0.005	0.018	364	<0.005	0.725	0.006	0.022

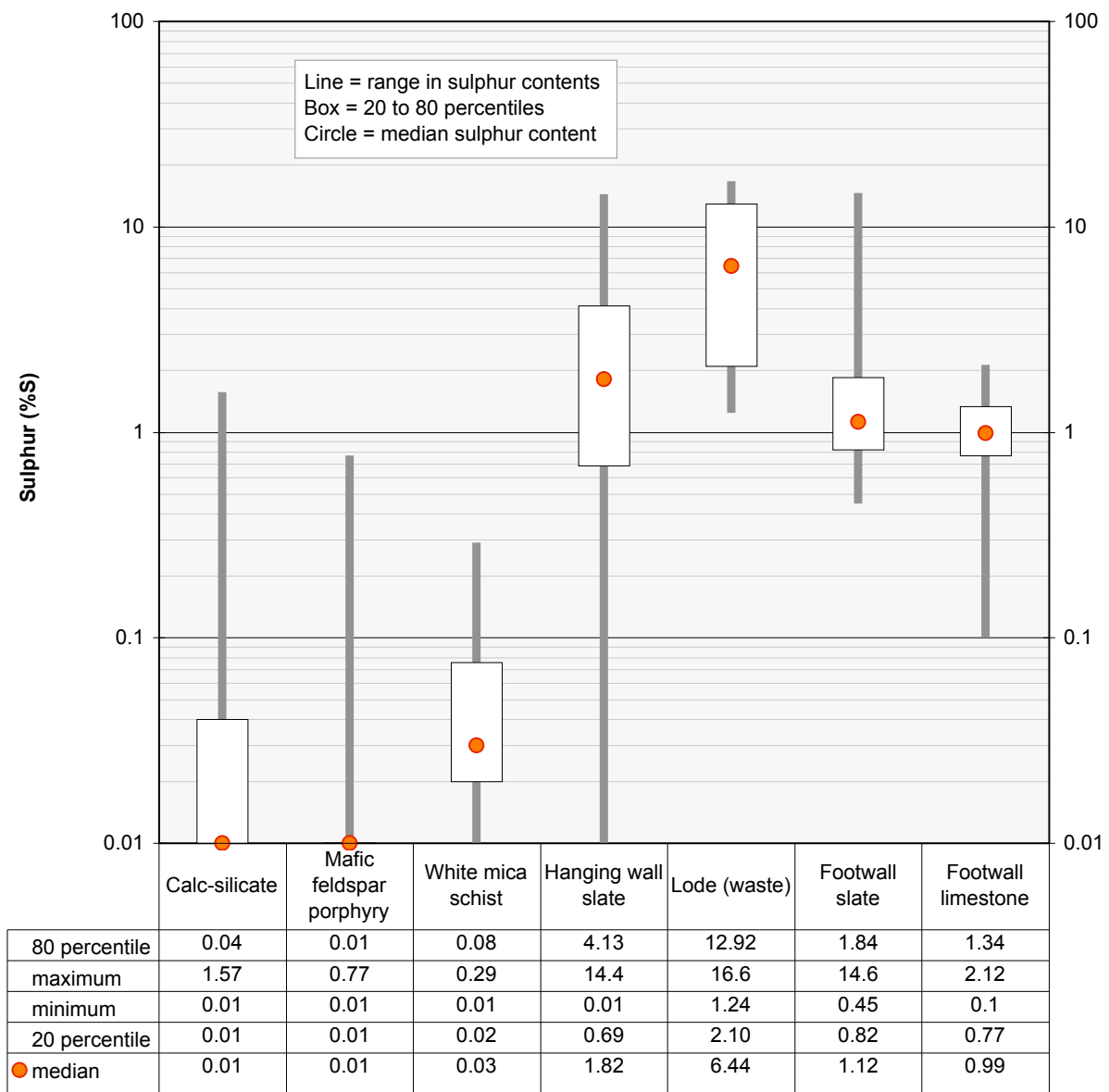


# Figures

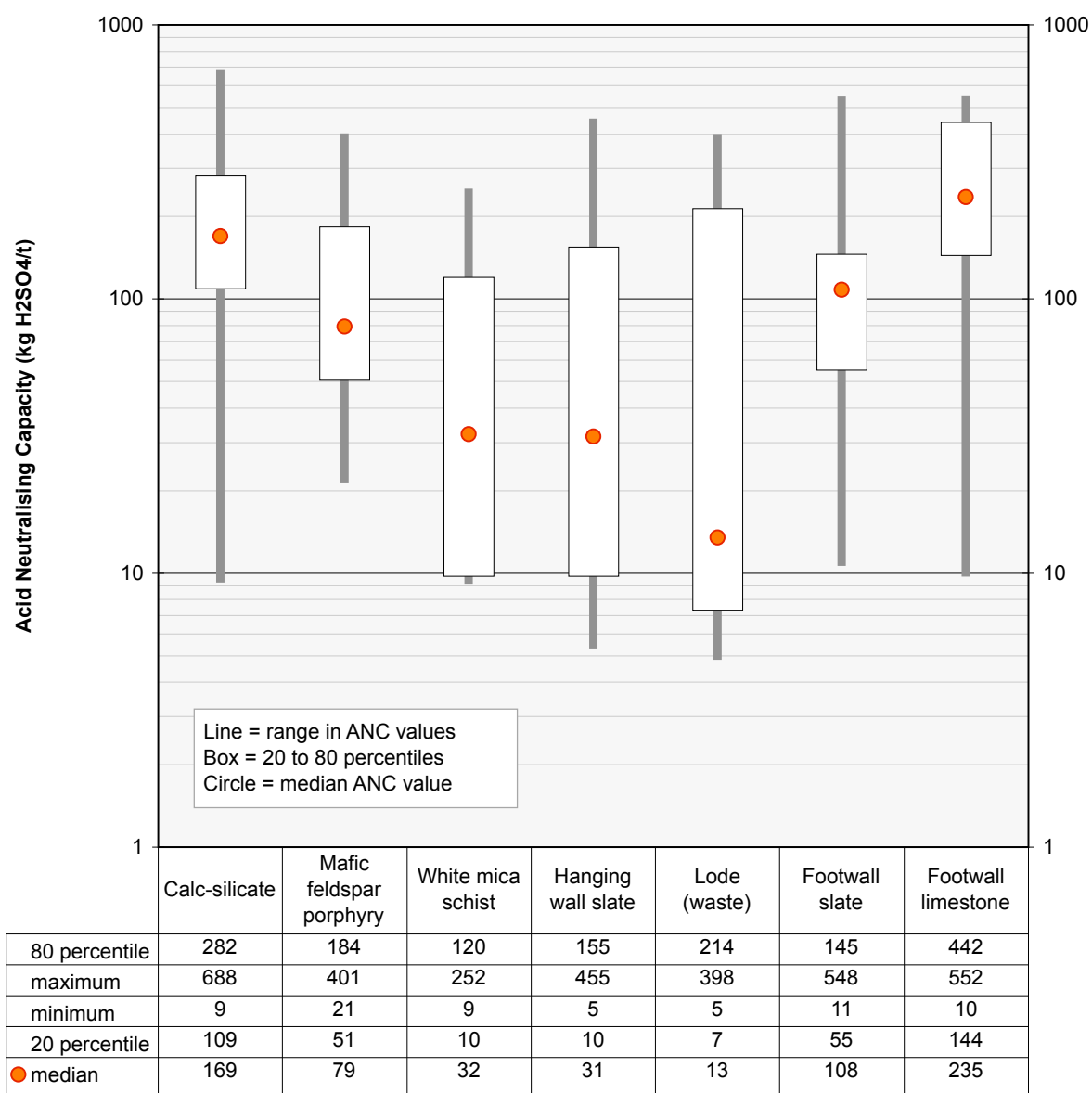


Waste Rock Type	
■ Calc Silicate	(8)
■ Footwall Limestone	(20)
■ Footwall Slate	(20)
■ Hanging Wall Slate - non sulphide	(4)
■ Hanging Wall Slate - Si Ab alt	(4)
■ Lode (mineralised Waste)	(8)
■ Mafic Feldspar Porphyry	(4)
■ Schist	(4)

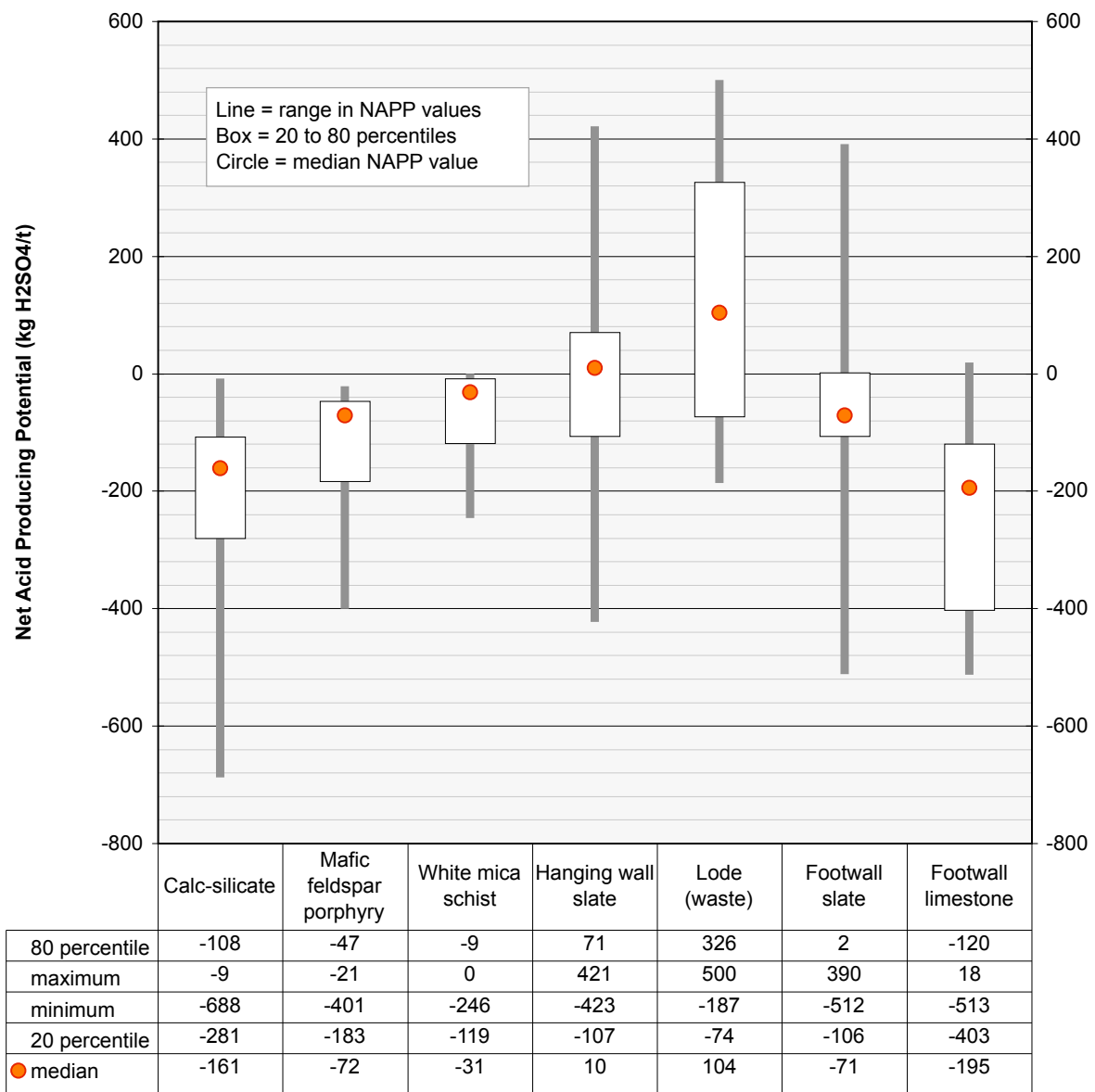
Figure 1	
Dugald River Project	
Waste Rock Sampling Program	
Date: 27/6/2010	
Author:	
Office:	
Drawing:	
Scale:	Projection: Local Grid (m)



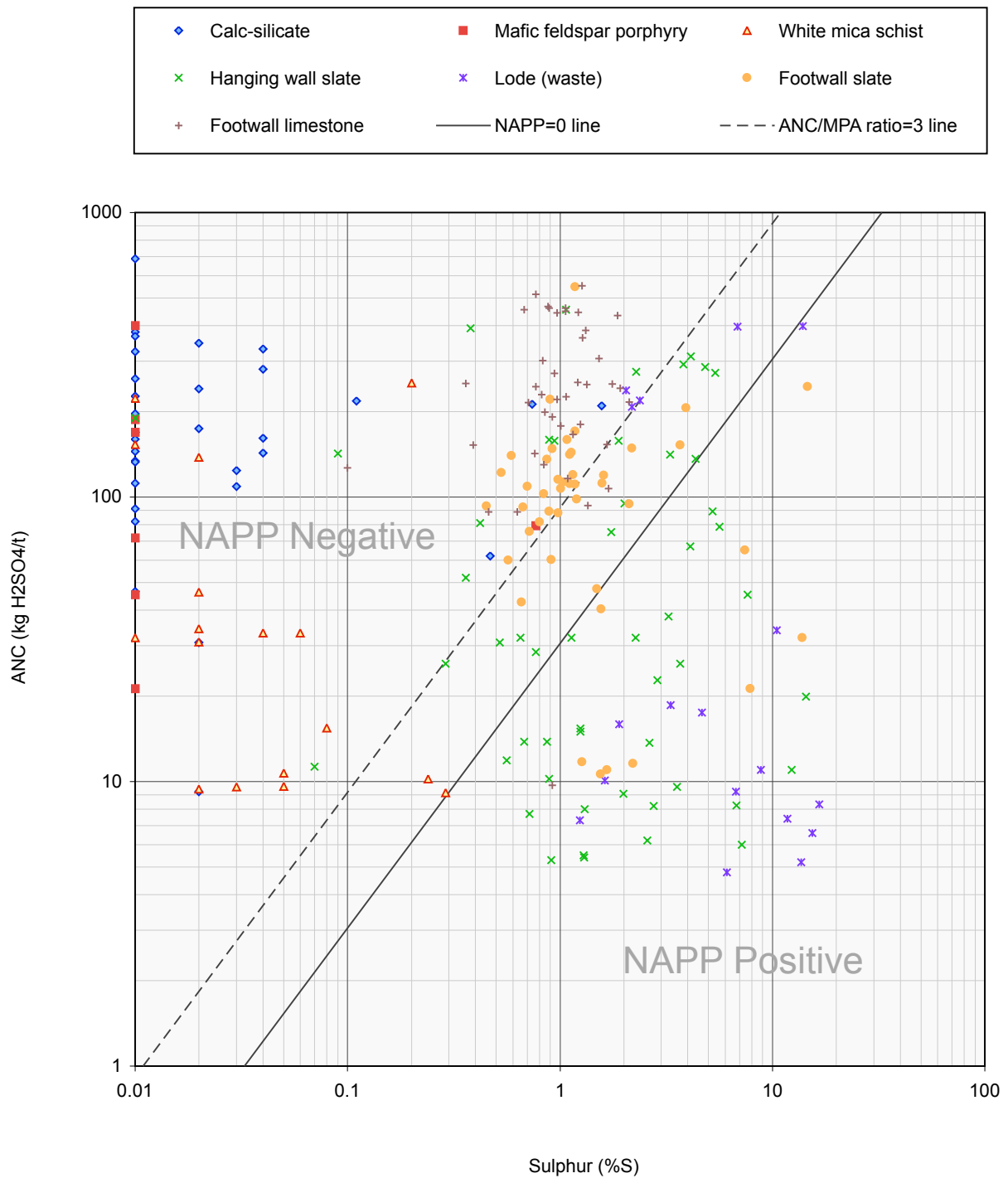
**FIGURE 2: Statistical summary of sulphur data for Dugald River waste rock**  
(compilation of results from all geochemical studies)



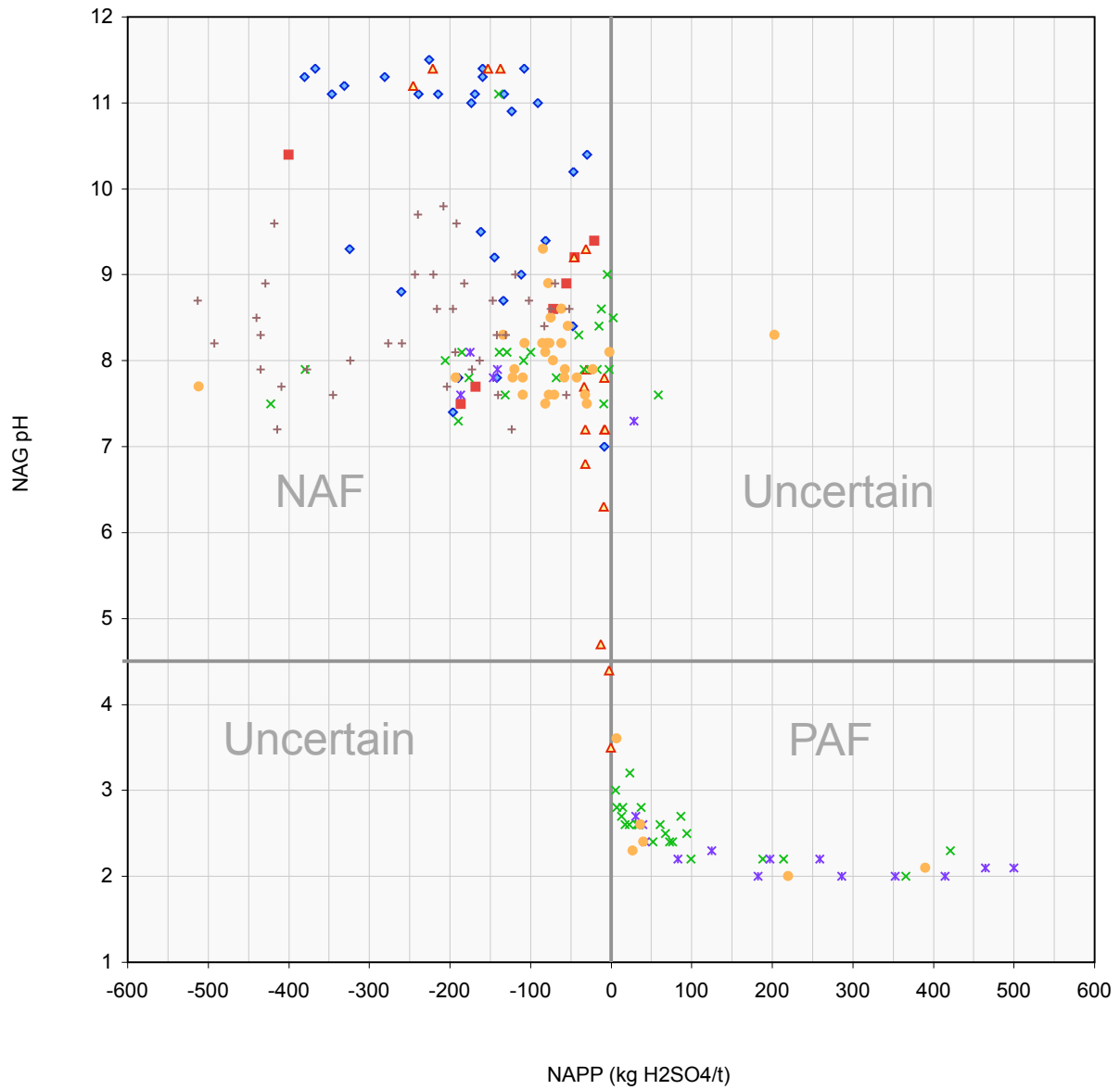
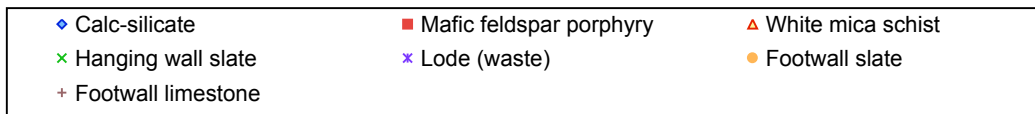
**FIGURE 3: Statistical summary of ANC data for Dugald River waste rock**  
(compilation of results from all geochemical studies)



**FIGURE 4: Statistical summary of NAPP data for Dugald River waste rock**  
(compilation of results from all geochemical studies)

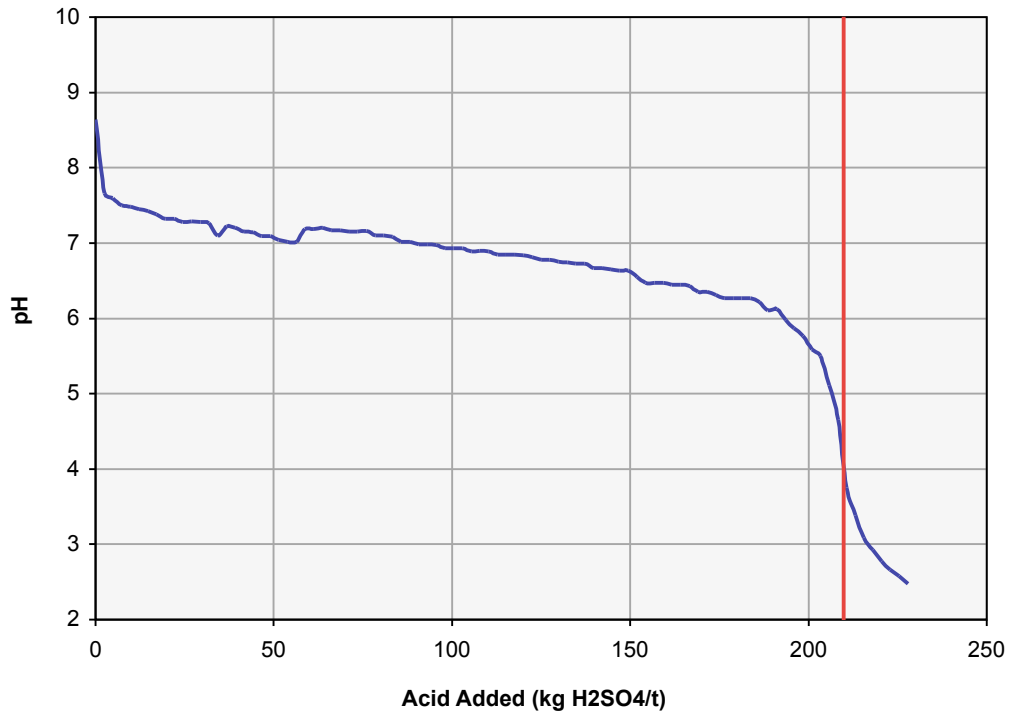


**FIGURE 5: Acid-base account plot for Dugald River waste rock**  
 (compilation of results from all geochemical studies)



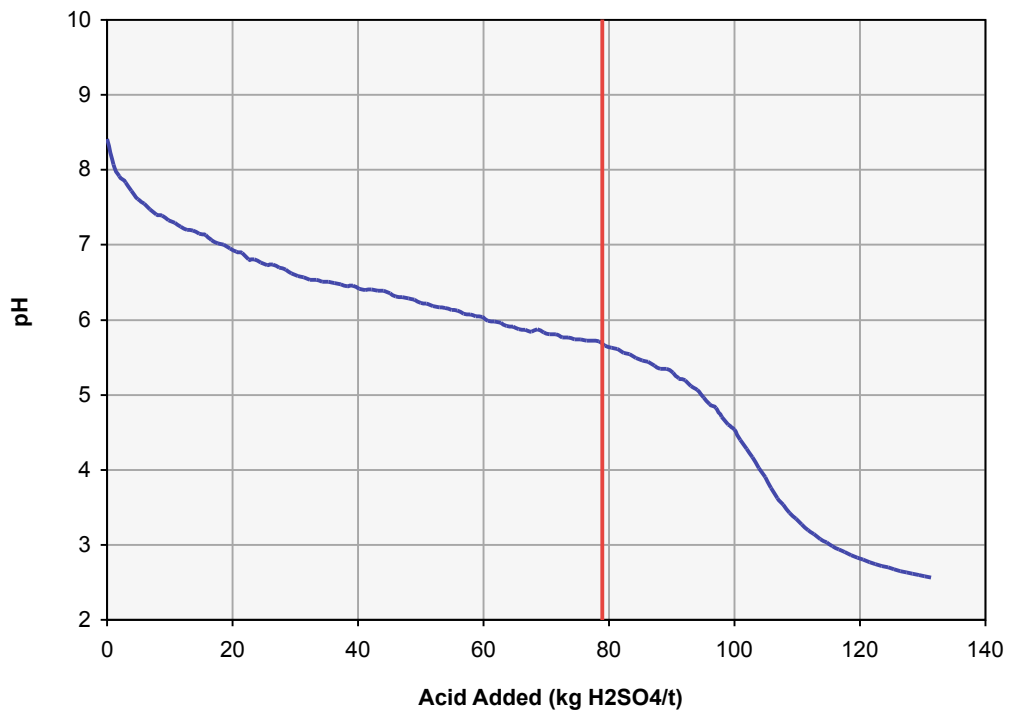
**FIGURE 6: ARD classification plot for Dugald River waste rock**  
 (compilation of results from all geochemical studies)





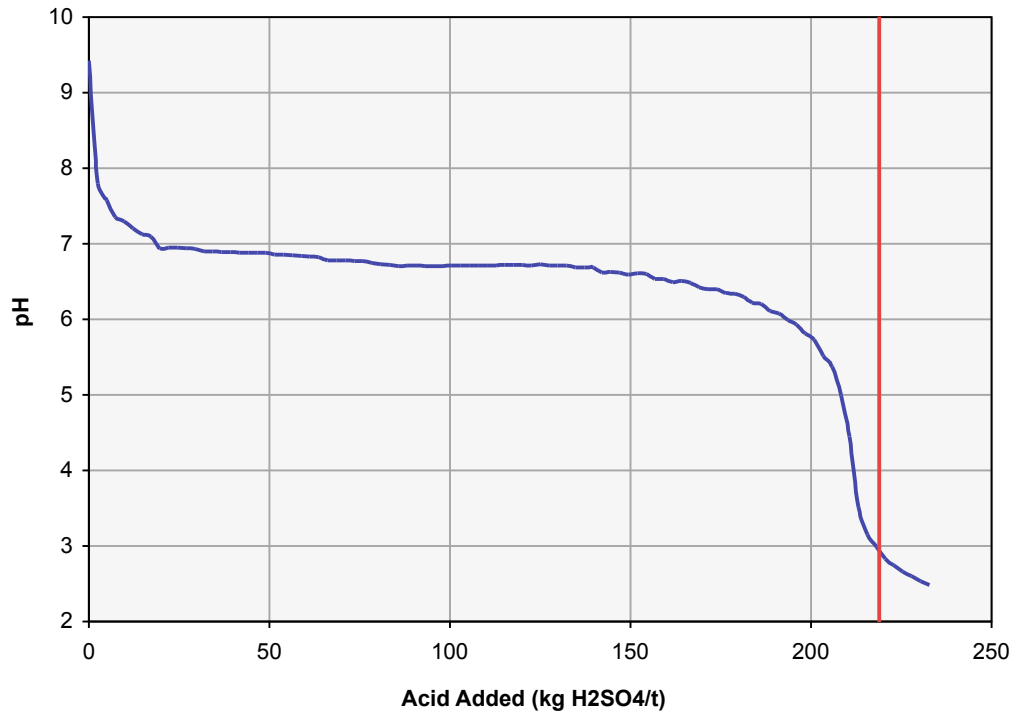
MMG / EGi Codes = 80448 / 40886	ANC = 210 kg H <sub>2</sub> SO <sub>4</sub> /t
---------------------------------	--

**FIGURE 7(a) - Acid buffer characteristic curve for Dugald River waste rock - Calc-silicate**



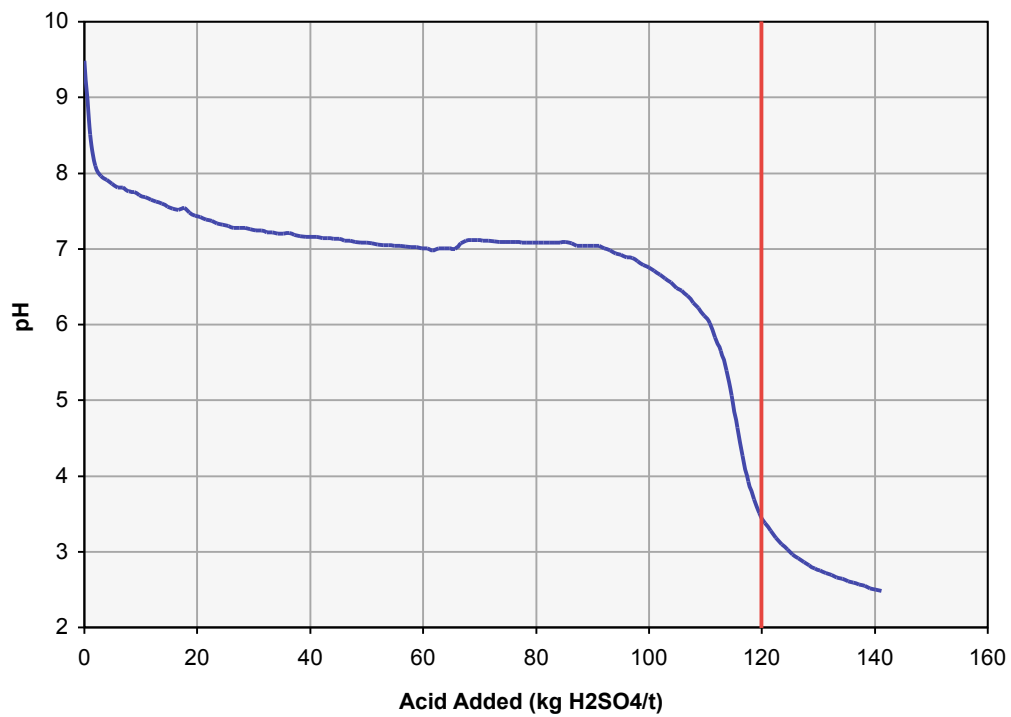
MMG / EGi Codes = 80424 / 40862	ANC = 79 kg H <sub>2</sub> SO <sub>4</sub> /t
---------------------------------	---

**FIGURE 7(b) - Acid buffer characteristic curve for Dugald River waste rock - Mafic feldspar porphyry**



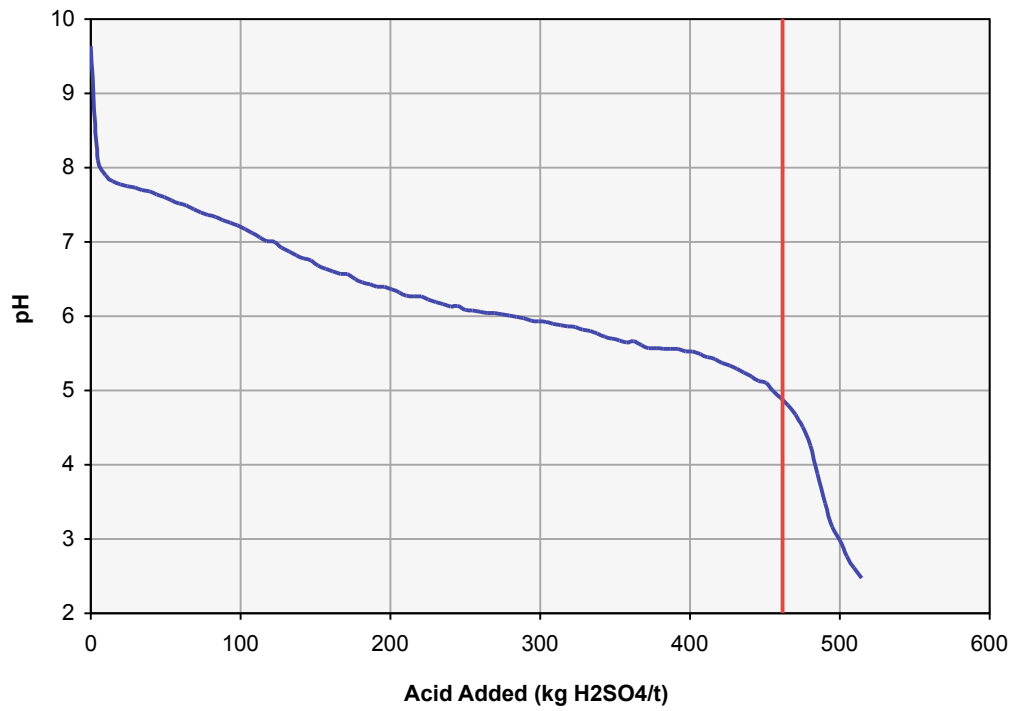
MMG / EGi Codes = 80478 / 40916	ANC = 219 kg H <sub>2</sub> SO <sub>4</sub> /t
---------------------------------	--

**FIGURE 7(c) - Acid buffer characteristic curve for Dugald River waste rock - Lode waste**



MMG / EGi Codes = 80430 / 40868	ANC = 120 kg H <sub>2</sub> SO <sub>4</sub> /t
---------------------------------	--

**FIGURE 7(d) - Acid buffer characteristic curve for Dugald River waste rock - Foot wall slate**



MMG / EGi Codes = 80436 / 40874	ANC = 462 kg H <sub>2</sub> SO <sub>4</sub> /t
---------------------------------	--

**FIGURE 7(e) - Acid buffer characteristic curve for Dugald River waste rock - Footwall limestone**

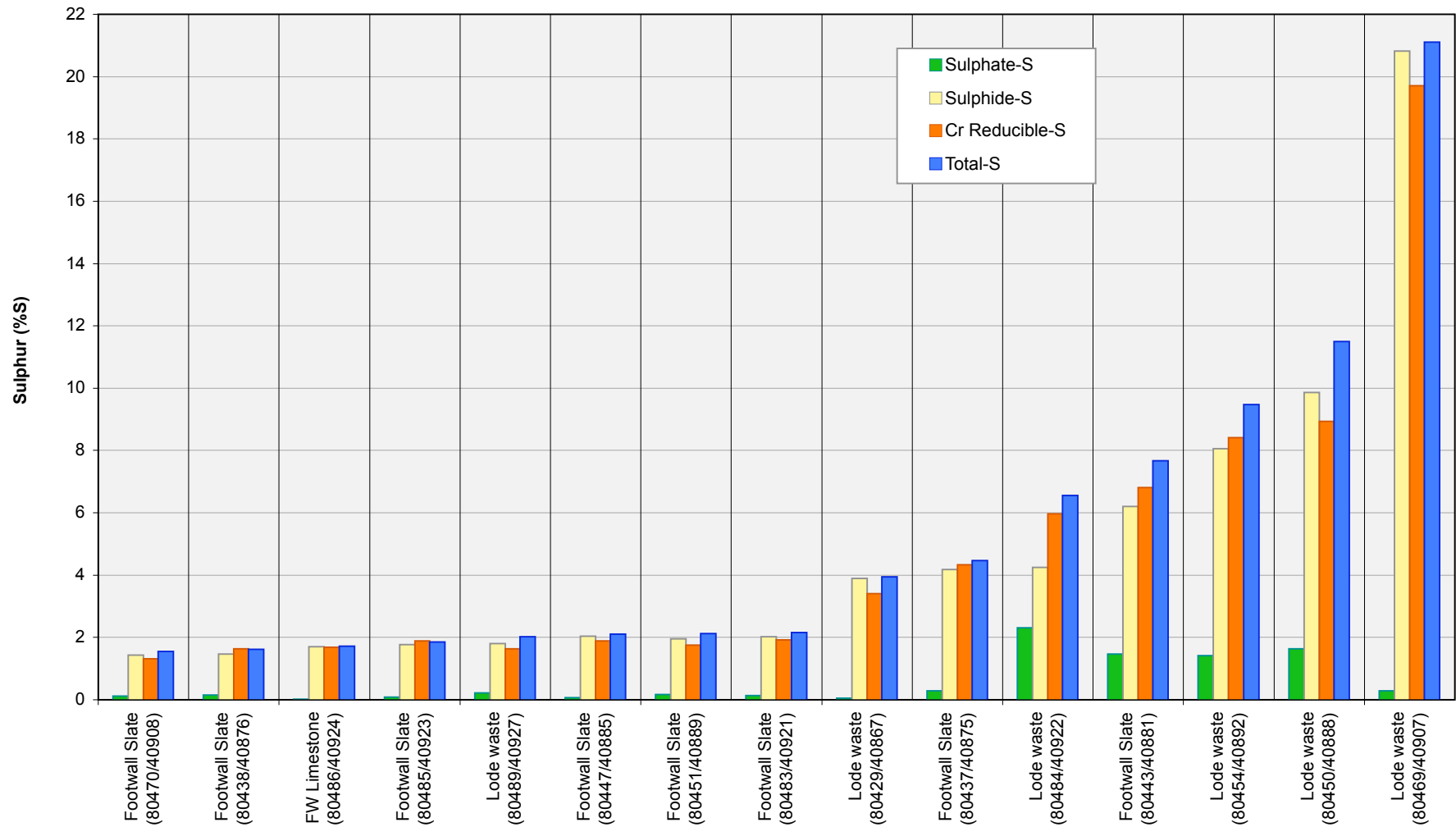


FIGURE 8: Sulphur speciation results for Dugald River waste rock

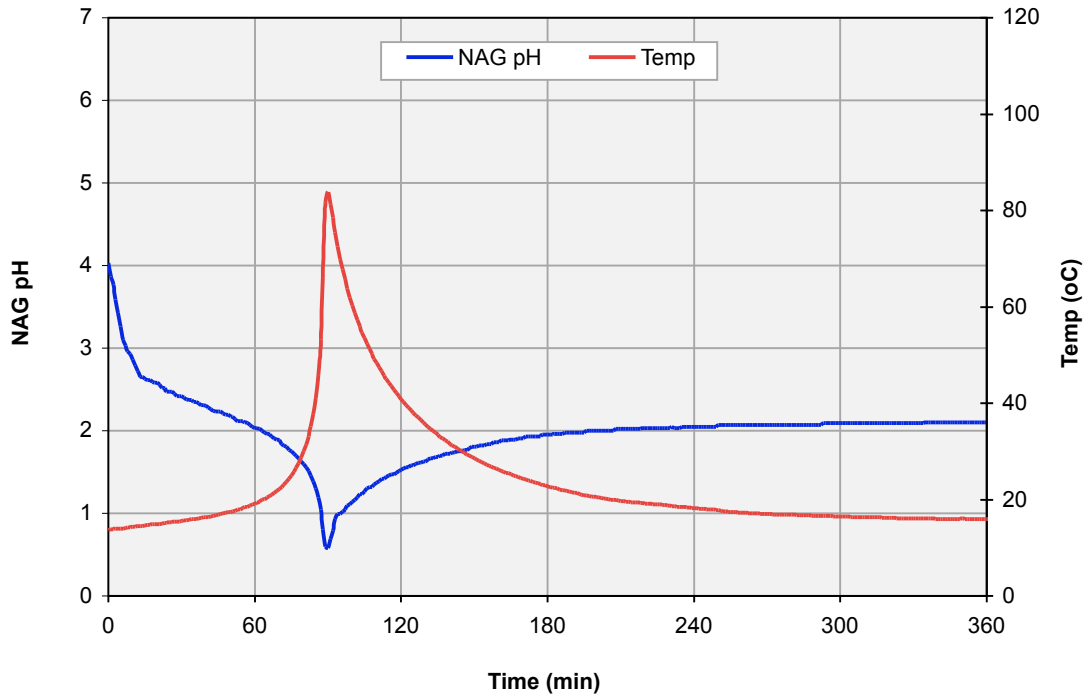


FIGURE 9(a): Kinetic NAG profiles for Dugald River waste rock - Lode waste

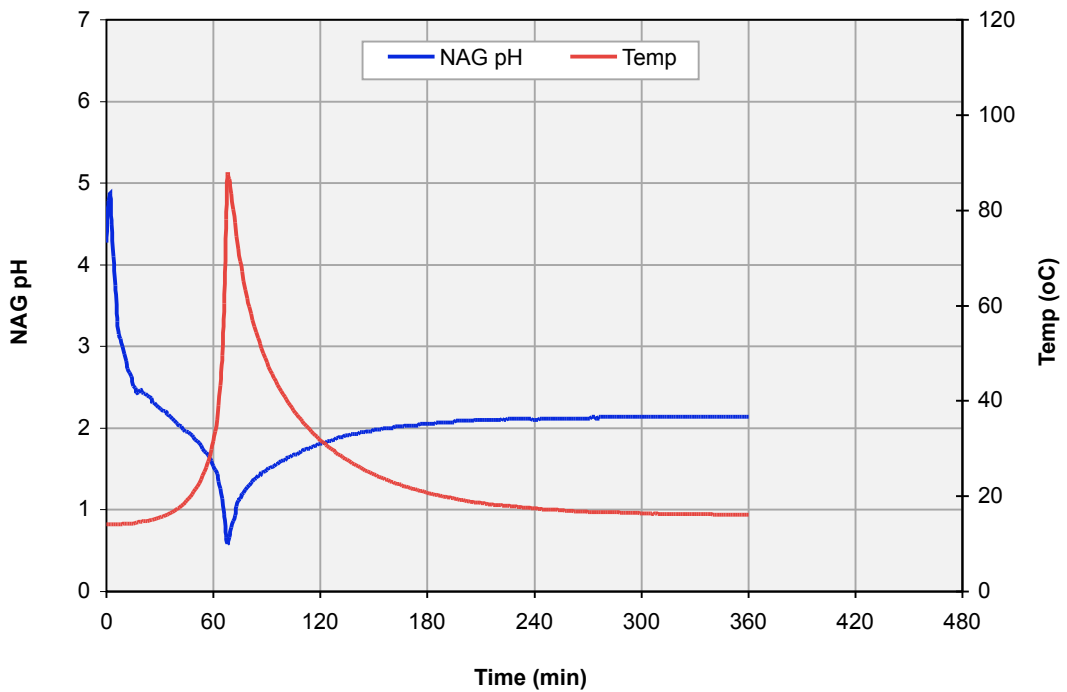
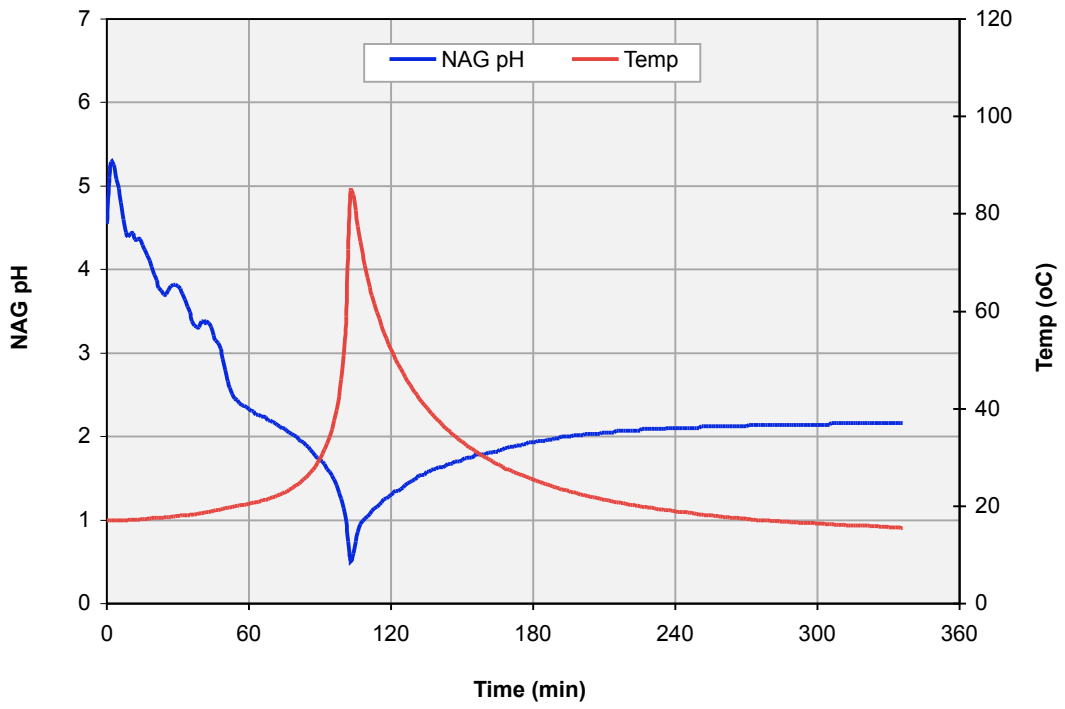
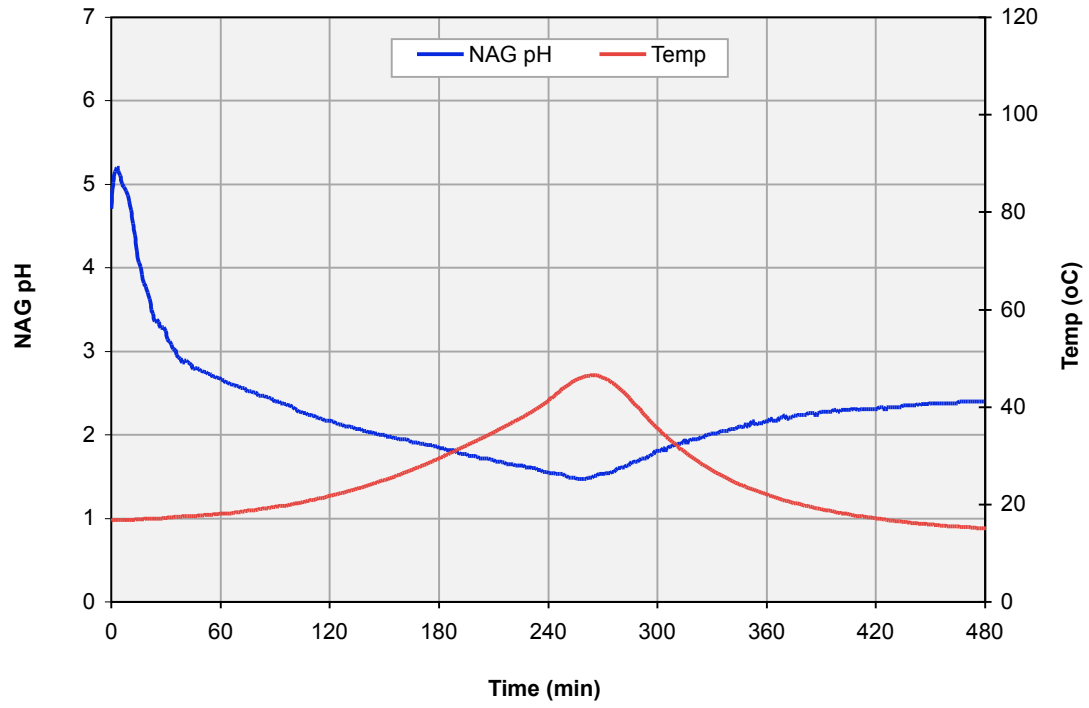


FIGURE 9(b): Kinetic NAG profiles for Dugald River waste rock - Lode waste



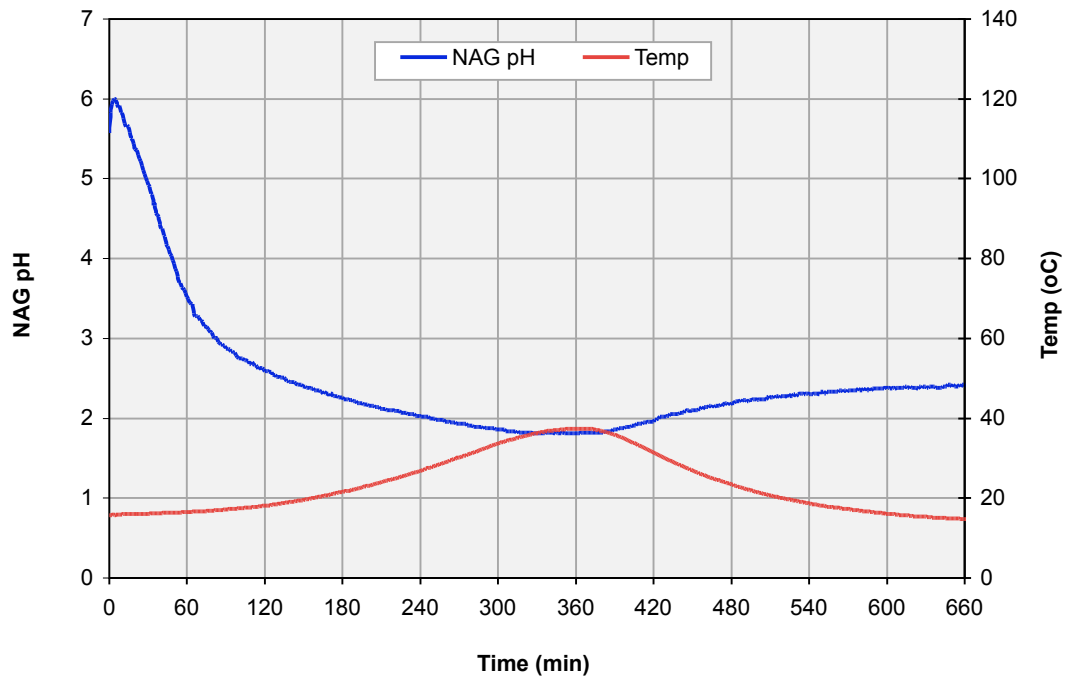
MMG Code = 80443 EGi Code = 40881  
 7.88%S, ANC = 21 kg H2SO4/t, NAPP = 220 kg H2SO4/t, NAGpH = 2.3

FIGURE 9(c): Kinetic NAG profiles for Dugald River waste rock - Foot wall slate



MMG Code = 80483 EGi Code = 40921  
 1.99%S, ANC = 9 kg H2SO4/t, NAPP = 52 kg H2SO4/t, NAGpH = 2.4

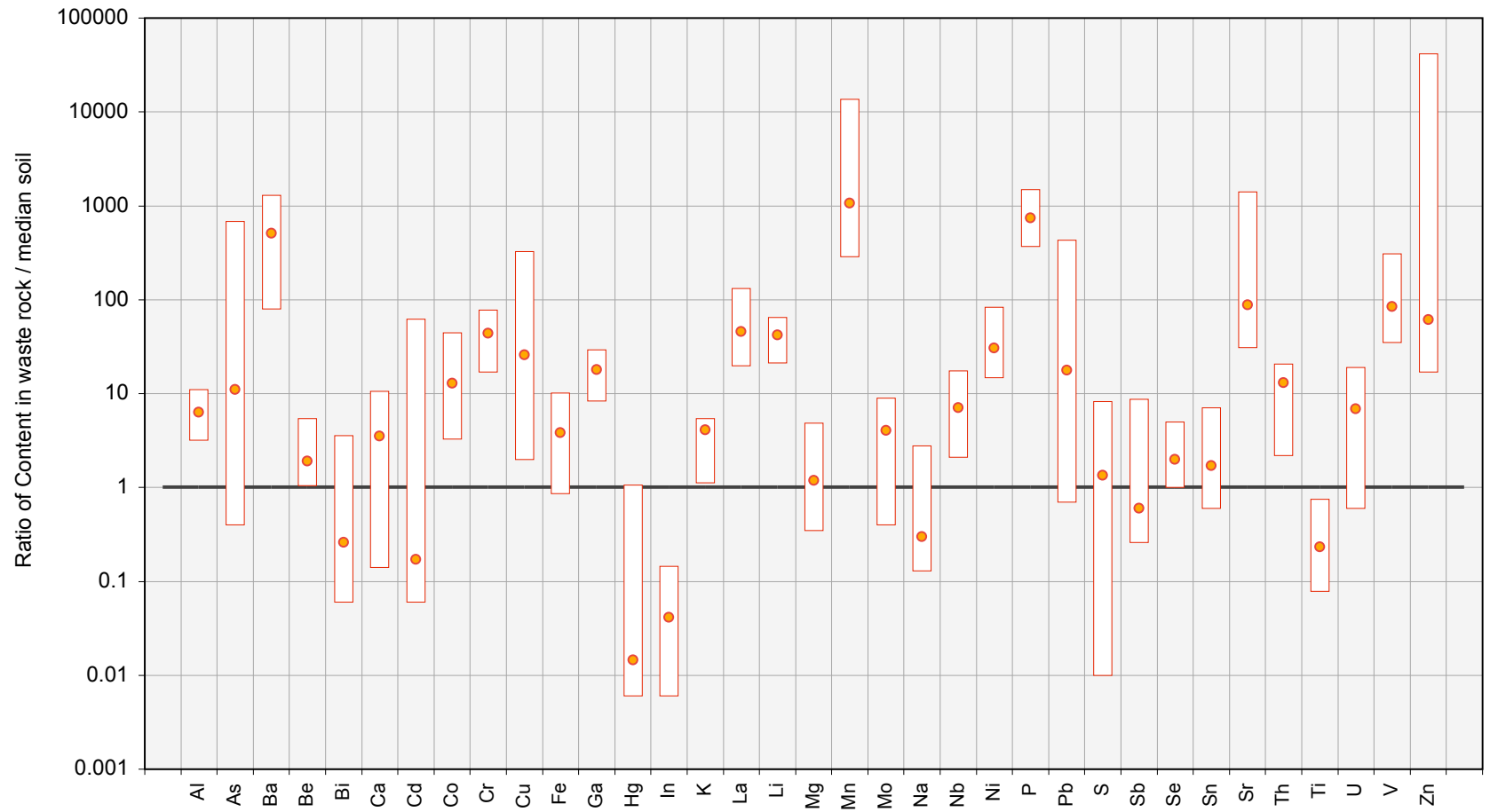
FIGURE 9(d): Kinetic NAG profiles for Dugald River waste rock - Hanging wall slate



MMG Code = 80438 EGi Code = 40876  
 1.66%S, ANC = 11 kg H<sub>2</sub>SO<sub>4</sub>/t, NAPP = 40 kg H<sub>2</sub>SO<sub>4</sub>/t, NAGpH = 2.4

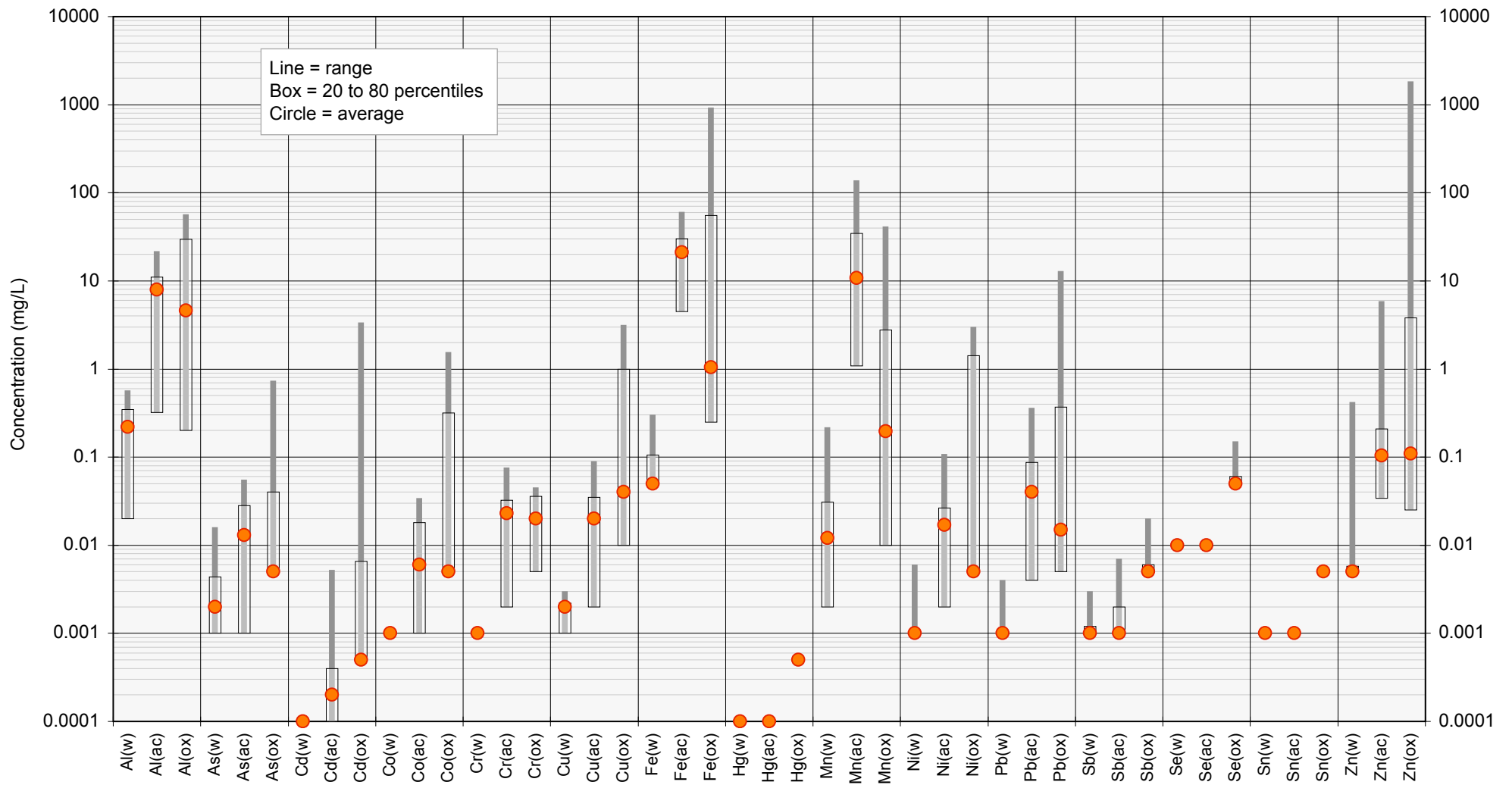
**FIGURE 9(e): Kinetic NAG profiles for Dugald River waste rock - Foot wall slate**





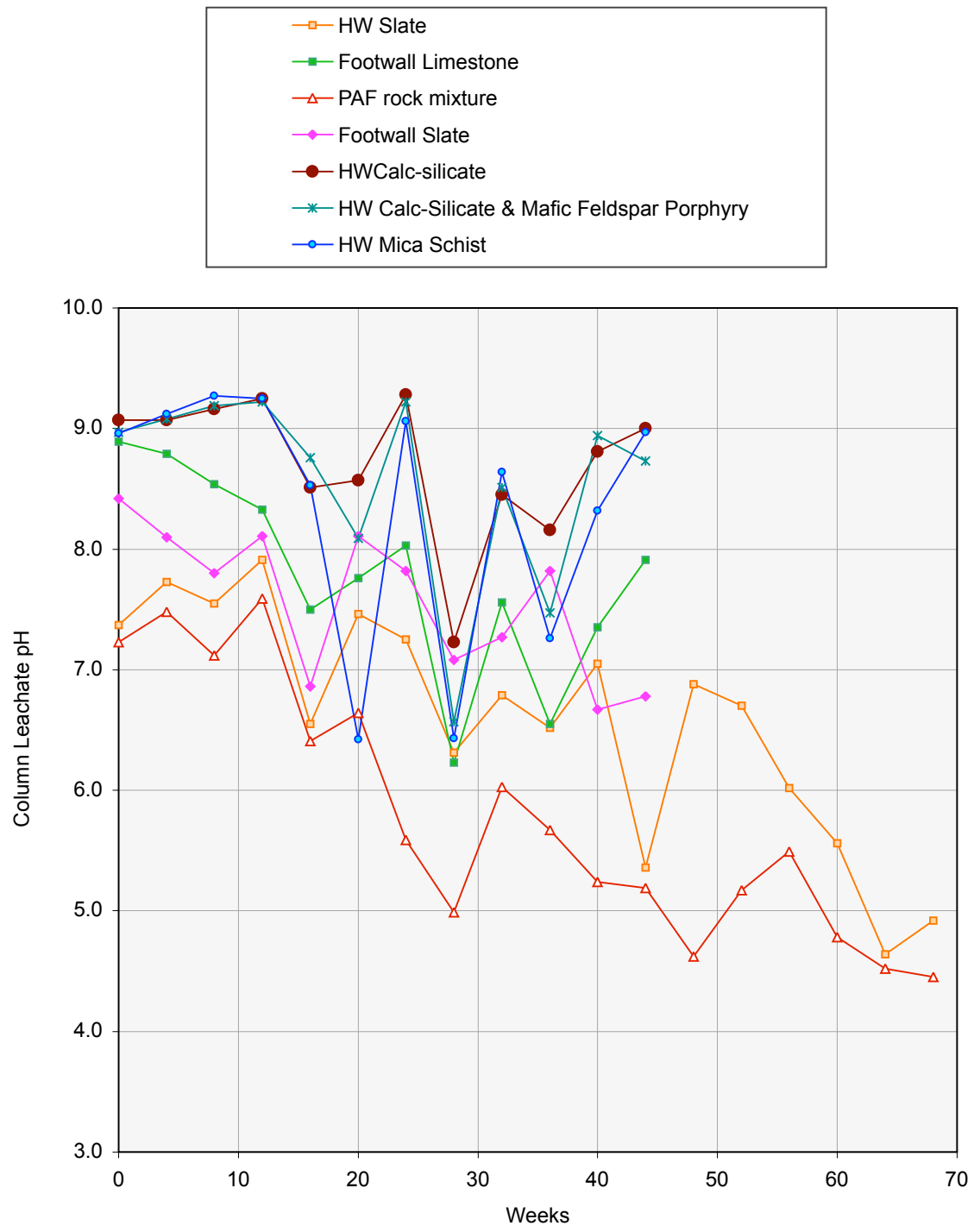
**FIGURE 10: Box plot showing the ratios of element concentrations in Dugald River waste rock relative to median soil composition**

(Bars = range in ratios      Circles = median ratio)

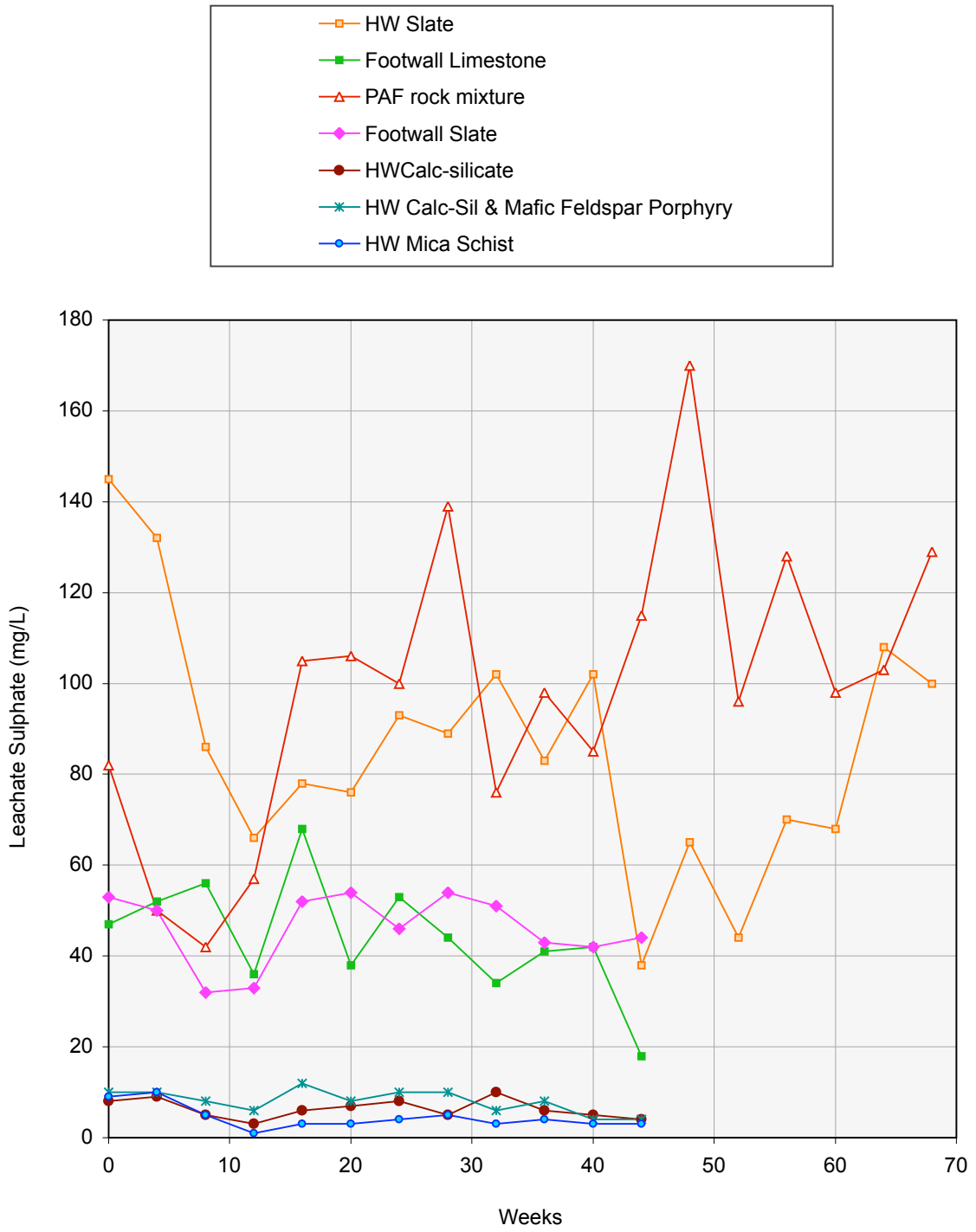


**FIGURE 11: Statistical summary of extract assay data for water (w), acid (ac) and peroxide (ox) extraction tests for Dugald River waste rock**

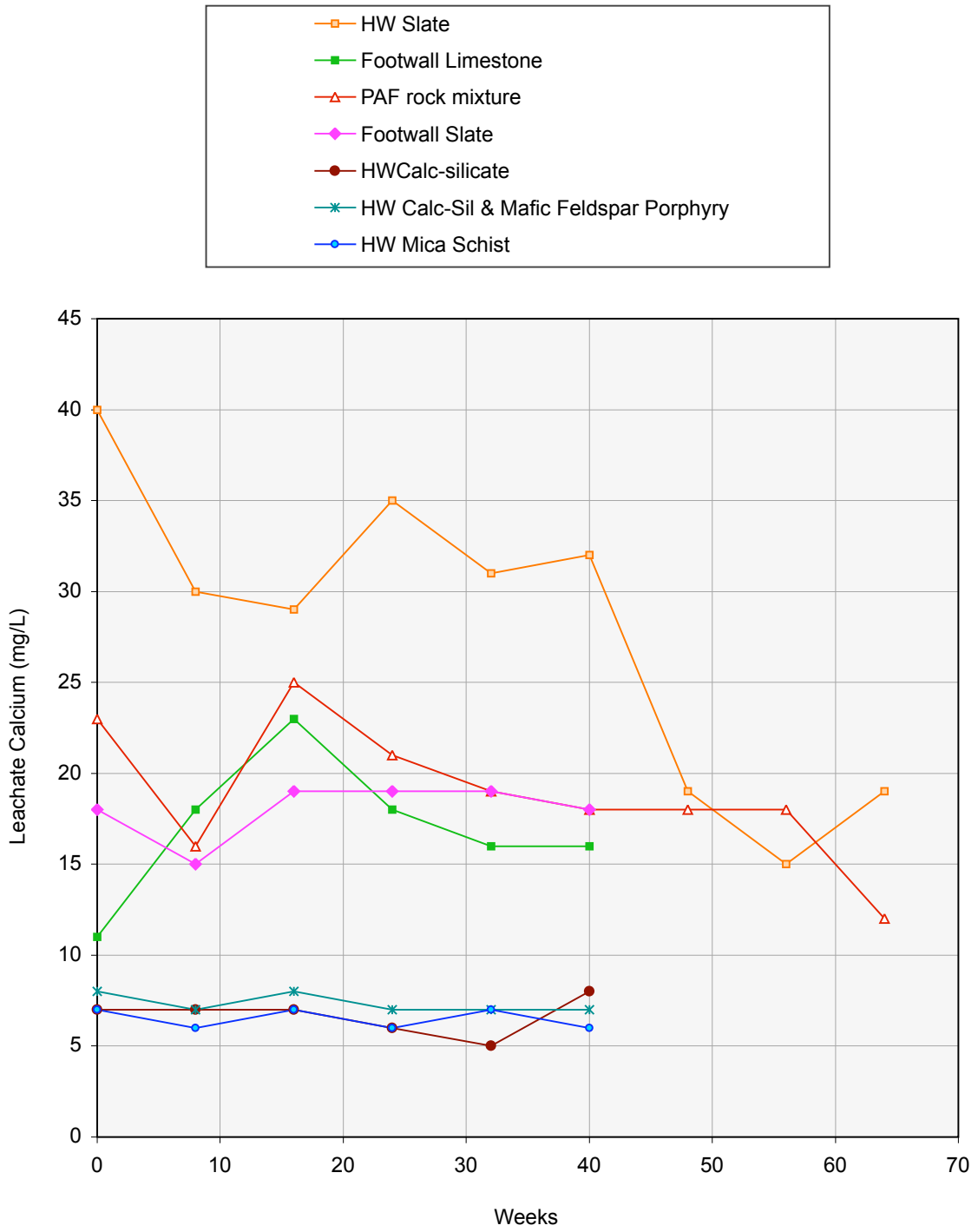
(note: For comparison purposes the peroxide results were multiplied by a factor of 5 to simulate a solid:liquor ratio of 1:20 ratio as used in the water and acid extractions.)



**FIGURE 12: Plot of leachate pH for AARC column leach tests on Dugald River waste rock**



**FIGURE 13: Plot of sulphate concentrations in leachates from AARC column leach tests on Dugald River waste rock**



**FIGURE 14: Plot of calcium concentrations in leachates from AARC column leach tests on Dugald River waste rock**

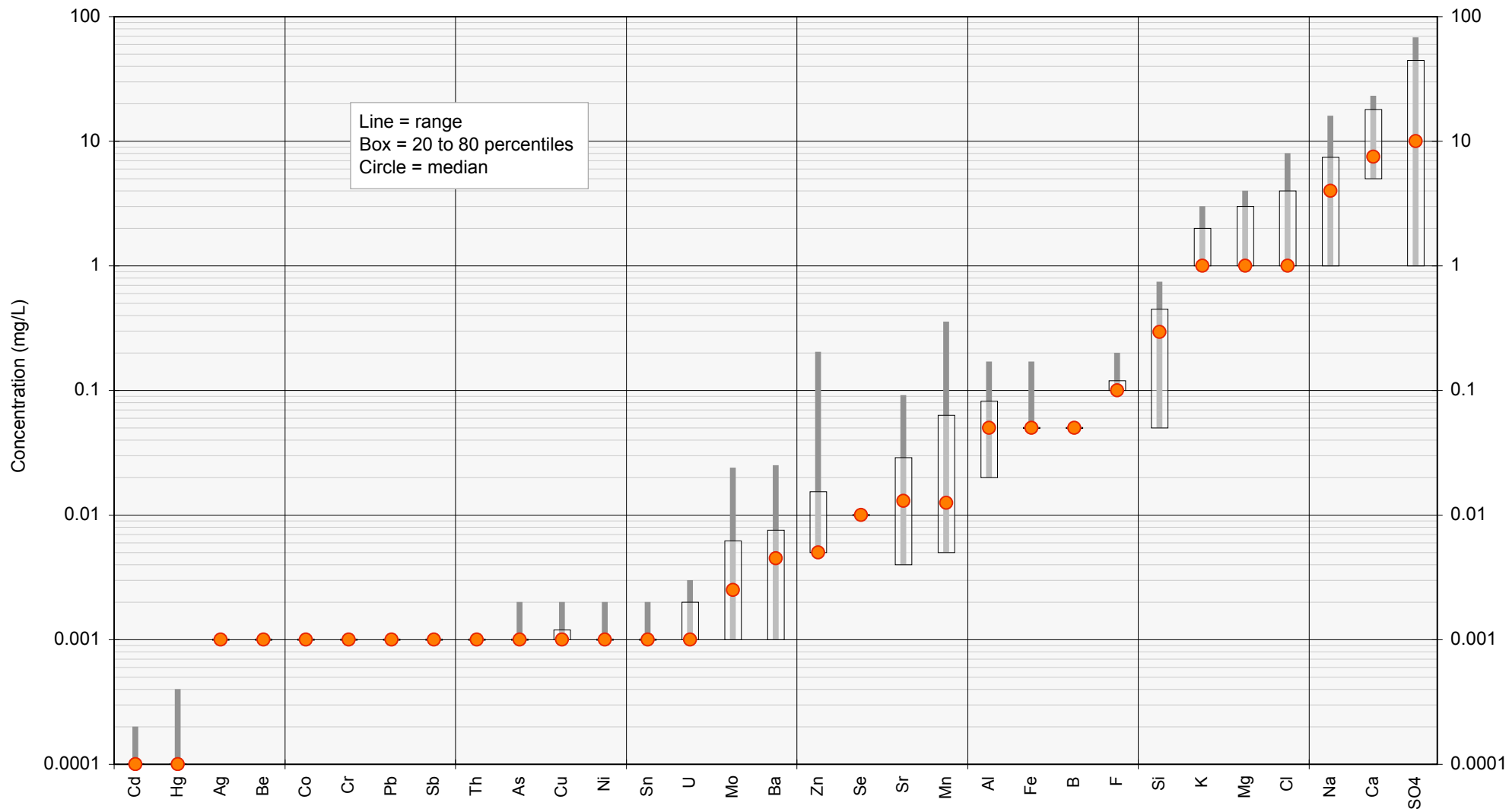
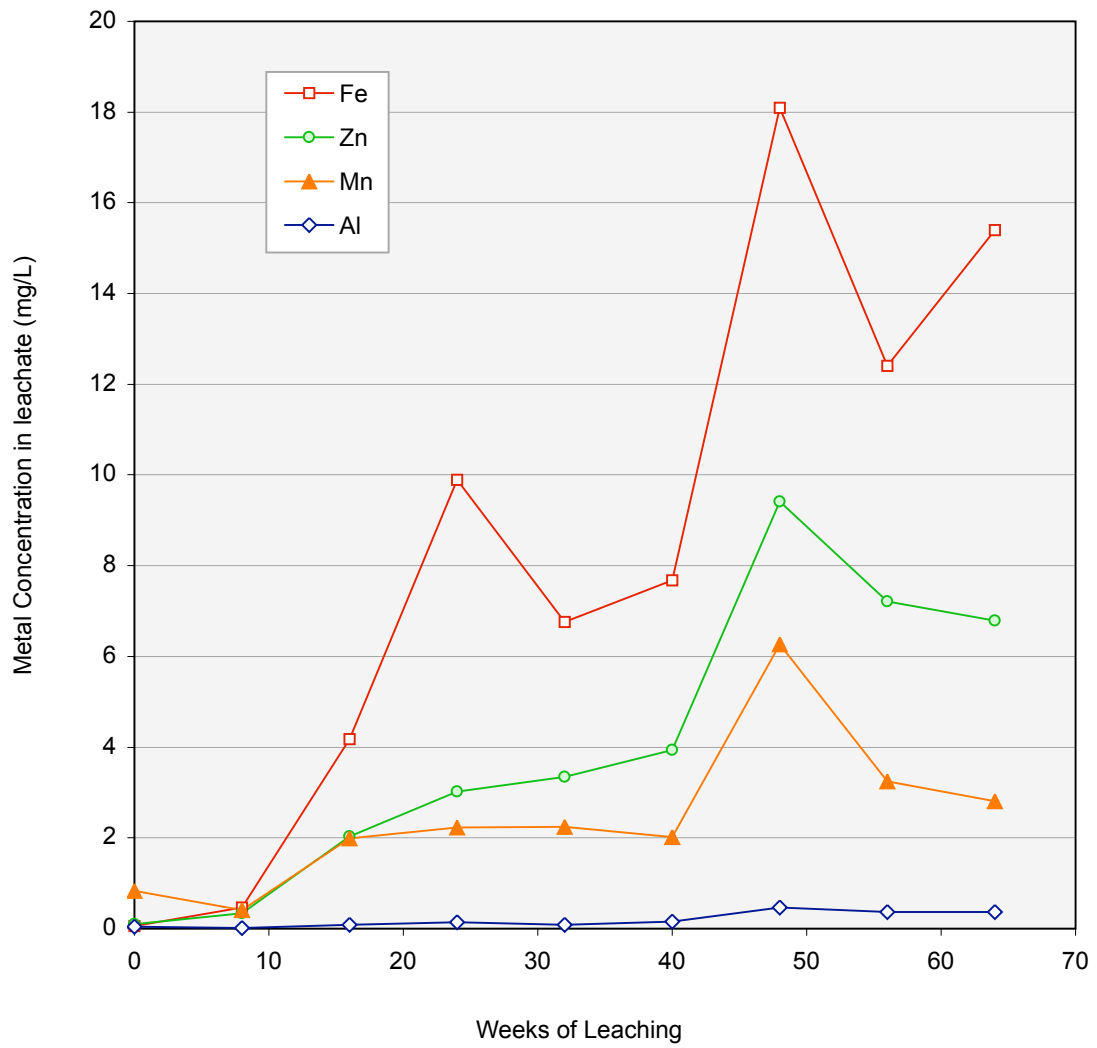


FIGURE 15: Statistical summary of AARC column leach assay data for samples comprising NAF Dugald River waste rock



**FIGURE 16: Plot of Fe, Zn, Mn and Al concentrations in leachate from Column 3 containing a PAF waste mixture**



# Appendix A

## Acid Forming Characteristics of Drill Core Samples from Previous Geochemical Studies of Dugald River Waste Rock

AGC-Woodward Clyde (1991)  
AustralAsian Resource Consultants (2008)

**APPENDIX A : Acid forming characteristics of drill core samples from previous geochemical studies of Dugald River waste rock**

Study	Sample ID	Hole No.	From (m)	To (m)	Interval (m)	Lithology	EC	Existing pH	Total %S	MPA	ANC	ANC/MPA Ratio	NAPP	NAG	NAGpH	ARD Class
AGC-WWC 1991	-	229	700	701	1.0	Hanging wall slate	430	7.4	0.36	11	52	4.7	-41	-	-	NAF
AGC-WWC 1991	-	174	168	169	1.0	Hanging wall slate	1260	6.5	1.74	53	75	1.4	-22	-	-	NAF
AGC-WWC 1991	-	230	662	663	1.0	Hanging wall slate	370	7.9	1.25	38	15	0.4	23	-	-	PAF
AGC-WWC 1991	-	230	675	676	1.0	Hanging wall slate	890	7.35	2.88	88	23	0.3	65	-	-	PAF
AGC-WWC 1991	-	186	672	673	1.0	Hanging wall slate	1106	7.71	5.24	160	89	0.6	71	-	-	PAF
AGC-WWC 1991	-	231	491	492	1.0	Hanging wall slate	500	7.48	6.79	208	8	0.0	200	-	-	PAF
AGC-WWC 1991	-	174	171	172	1.0	Lode ore	640	7.3	15.3	468	225	0.5	244	-	-	PAF
AGC-WWC 1991	-	186	684	685	1.0	Lode ore	520	6.9	14.5	444	109	0.2	335	-	-	PAF
AGC-WWC 1991	-	229	720	721	1.0	Lode ore	607	8.1	12.2	373	22	0.1	352	-	-	PAF
AGC-WWC 1991	-	231	500	501	1.0	Lode ore	421	7.2	16.3	499	12	0.0	486	-	-	PAF
AGC-WWC 1991	-	230	684	685	1.0	Lode ore	910	6.4	20.1	615	22	0.0	593	-	-	PAF
AGC-WWC 1991	-	186	696	697	1.0	Footwall slate	310	8.1	1.08	33	159	4.8	-126	-	-	NAF
AGC-WWC 1991	-	230	703	704	1.0	Footwall slate	410	8	0.53	16	122	7.5	-106	-	-	NAF
AGC-WWC 1991	-	229	747	748	1.0	Footwall slate	472	8.14	3.91	120	206	1.7	-86	-	-	NAF
AGC-WWC 1991	-	174	180	181	1.0	Footwall slate	1230	7.1	1.58	48	112	2.3	-63	-	-	NAF
AGC-WWC 1991	-	231	508	509	1.0	Footwall slate	609	8	3.67	112	152	1.4	-40	-	-	NAF
AGC-WWC 1991	-	231	540	541	1.0	Footwall slate	300	9.1	0.7	21	109	5.1	-87	-	-	NAF
AGC-WWC 1991	-	217	1029	1030	1.0	Footwall slate	256	8.98	2.21	68	12	0.2	56	-	-	PAF
AGC-WWC 1991	-	202	792	793	1.0	Footwall slate	521	8.09	7.44	228	65	0.3	162	-	-	PAF
AGC-WWC 1991	-	186	824	825	1.0	Footwall limestone	305	8.3	0.97	30	221	7.4	-191	-	-	NAF
AGC-WWC 1991	-	174	185	186	1.0	Footwall limestone	820	7.65	2.12	65	215	3.3	-151	-	-	NAF
AGC-WWC 1991	-	217	1040	1041	1.0	Footwall limestone	210	9.1	0.84	26	130	5.0	-104	-	-	NAF
AGC-WWC 1991	-	230	760	761	1.0	Footwall limestone	330	8.3	0.92	28	10	0.3	18	-	-	PAF

APPENDIX A : Continued

Study	Sample ID	Hole No.	From (m)	To (m)	Interval (m)	Lithology	EC	Existing pH	Total %S	MPA	ANC	ANC/MPA Ratio	NAPP	NAG	NAGpH	ARD Class
AARC 2008	34180	DR319	121	121.5	0.5	Calc-silicate	319	9.0	0.01	0	688	2248	-688	0	11.5	NAF
AARC 2008	34189	DR322	132	132.5	0.5	Calc-silicate	173	9.5	0.01	0	381	1245	-381	0	11.3	NAF
AARC 2008	34181	DR319	121.5	122	0.5	Calc-silicate	135	9.6	<u>0.01</u>	0	367	-	-367	0	11.4	NAF
AARC 2008	34195	DR321	177.5	178	0.5	Calc-silicate	156	9.4	0.02	1	347	567	-346	0	11.1	NAF
AARC 2008	34188	DR322	129	129.5	0.5	Calc-silicate	206	9.3	0.04	1	332	271	-331	0	11.2	NAF
AARC 2008	34187	DR322	126	126.5	0.5	Calc-silicate	168	9.6	0.01	0	325	1062	-325	0	9.3	NAF
AARC 2008	34199	DR318	227	227.45	0.45	Calc-silicate	241	9.2	0.04	1	282	230	-281	0	11.3	NAF
AARC 2008	34046	DR342	107	107.5	0.5	Calc-silicate	122	9.5	0.02	1	240	392	-239	0	11.1	NAF
AARC 2008	34183	DR319	124.5	125	0.5	Calc-silicate	133	9.6	0.01	0	226	739	-226	0	11.5	NAF
AARC 2008	34174	DR320	112	112.5	0.5	Calc-silicate	154	9.5	0.11	3	218	65	-215	0	11.1	NAF
AARC 2008	34200	DR318	227.45	228	0.55	Calc-silicate	203	9.2	0.02	1	174	284	-173	0	11.0	NAF
AARC 2008	34182	DR319	124	124.5	0.5	Calc-silicate	153	9.5	0.01	0	169	552	-169	0	11.1	NAF
AARC 2008	34175	DR320	112.5	113	0.5	Calc-silicate	126	9.7	0.04	1	161	132	-160	0	11.4	NAF
AARC 2008	34026	DR342	106	106.5	0.5	Calc-silicate	123	9.4	0.01	0	160	523	-160	0	11.3	NAF
AARC 2008	34192	DR321	163	163.5	0.5	Calc-silicate	162	9.3	0.01	0	145	474	-145	0	9.2	NAF
AARC 2008	34198	DR318	225	225.5	0.5	Calc-silicate	200	9.4	0.01	0	133	435	-133	0	11.1	NAF
AARC 2008	34196	DR318	219	219.5	0.5	Calc-silicate	175	9.4	0.03	1	124	135	-123	0	10.9	NAF
AARC 2008	34193	DR321	166	166.5	0.5	Calc-silicate	134	9.5	0.01	0	112	366	-112	0	9.0	NAF
AARC 2008	34027	DR342	106.5	107	0.5	Calc-silicate	140	9.3	0.03	1	109	119	-108	0	11.4	NAF
AARC 2008	34197	DR318	222	222.5	0.5	Calc-silicate	141	9.5	<u>0.01</u>	0	91	-	-91	0	11.0	NAF
AARC 2008	34194	DR321	177	177.5	0.5	Calc-silicate	193	9.5	<u>0.01</u>	0	47	-	-47	0	10.2	NAF
AARC 2008	34009	DR346	140	140.5	0.5	Calc-silicate	121	9.3	0.02	1	31	50	-30	0	10.4	NAF
AARC 2008	34008	DR346	127.5	128	0.5	Calc-silicate	97	9.4	0.02	1	9	15	-9	0	7.0	NAF
AARC 2008	34029	DR342	151.5	152	0.5	Mafic feldspar porphyry	154	9.4	0.01	0	401	1310	-401	0	10.4	NAF
AARC 2008	34028	DR342	151	151.5	0.5	Mafic feldspar porphyry	132	9.8	<u>0.01</u>	0	45	-	-45	0	9.2	NAF
AARC 2008	34010	DR346	162.5	163	0.5	Mafic feldspar porphyry	107	9.5	<u>0.01</u>	0	21	-	-21	0	9.4	NAF
AARC 2008	34179	DR320	216.5	217	0.5	White mica schist	197	9.2	0.2	6	252	41	-246	0	11.2	NAF
AARC 2008	34177	DR320	212.5	213	0.5	White mica schist	163	9.5	0.01	0	222	725	-222	0	11.4	NAF
AARC 2008	34178	DR320	216	216.5	0.5	White mica schist	256	9.4	0.01	0	153	500	-153	0	11.4	NAF
AARC 2008	34176	DR320	212	212.5	0.5	White mica schist	189	9.3	0.02	1	138	225	-137	0	11.4	NAF
AARC 2008	34202	DR316	266	266.5	0.5	White mica schist	179	9.5	0.02	1	46	76	-46	0	9.2	NAF
AARC 2008	34205	DR316	272	272.5	0.5	White mica schist	151	9.7	0.02	1	34	56	-34	0	7.7	NAF
AARC 2008	34203	DR316	268	268.5	0.5	White mica schist	128	9.7	0.04	1	33	27	-32	0	7.2	NAF
AARC 2008	34204	DR316	270	270.5	0.5	White mica schist	137	9.7	0.01	0	32	105	-32	0	6.8	NAF
AARC 2008	34030	DR342	260	260.5	0.5	White mica schist	86	9.5	0.06	2	33	18	-31	0	9.3	NAF
AARC 2008	34201	DR316	264	264.5	0.5	White mica schist	132	9.6	0.02	1	31	50	-30	0	7.9	NAF
AARC 2008	34031	DR342	260.5	261	0.5	White mica schist	75	9.6	0.02	1	9	15	-9	0	7.8	NAF
AARC 2008	34047	DR342	273	273.5	0.5	White mica schist	68	9.7	0.03	1	10	10	-9	0	7.2	NAF
AARC 2008	34032	DR342	272.5	273	0.5	White mica schist	89	9.6	0.24	7	10	1.4	-3	1	4.4	UC (PAF)

APPENDIX A : Continued

Study	Sample ID	Hole No.	From (m)	To (m)	Interval (m)	Lithology	EC	Existing pH	Total %S	MPA	ANC	ANC/MPA Ratio	NAPP	NAG	NAGpH	ARD Class
AARC 2008	34035	DR342	363.5	364	0.5	Hanging wall slate	206	8.9	2.28	70	276	4.0	-206	0	8.0	NAF
AARC 2008	34033	DR342	362.5	363	0.5	Hanging wall slate	352	8.6	4.14	127	312	2.5	-185	0	8.1	NAF
AARC 2008	34034	DR342	363	363.5	0.5	Hanging wall slate	330	8.7	3.81	117	293	2.5	-176	0	7.8	NAF
AARC 2008	34191	DR322	162	162.5	0.5	Hanging wall slate	170	9.6	0.09	3	142	52	-139	0	11.1	NAF
AARC 2008	34037	DR342	364.5	365	0.5	Hanging wall slate	352	8.6	5.38	165	273	1.7	-108	0	8.0	NAF
AARC 2008	34039	DR342	365.5	366	0.5	Hanging wall slate	211	9.0	1.89	58	158	2.7	-100	0	8.1	NAF
AARC 2008	34165	DR315	102.5	103	0.5	Hanging wall slate	431	8.4	3.3	101	141	1.4	-40	0	8.3	NAF
AARC 2008	34038	DR342	365	365.5	0.5	Hanging wall slate	279	8.8	2.01	62	95	1.5	-33	0	7.9	NAF
AARC 2008	34052	DR341	111.5	112	0.5	Hanging wall slate	127	9.2	0.29	9	26	2.9	-17	0	7.9	NAF
AARC 2008	34051	DR341	111	111.5	0.5	Hanging wall slate	120	9.2	0.52	16	31	1.9	-15	0	8.4	NAF
AARC 2008	34014	DR346	409.5	410	0.5	Hanging wall slate	178	9.1	0.65	20	32	1.6	-12	0	8.6	NAF
AARC 2008	34190	DR322	157	157.5	0.5	Hanging wall slate	174	9.7	0.07	2	11	5	-9	0	7.5	NAF
AARC 2008	34049	DR341	99	99.5	0.5	Hanging wall slate	111	9.4	0.77	24	29	1.2	-5	0	9.0	NAF
AARC 2008	34036	DR342	364	364.5	0.5	Hanging wall slate	398	8.6	4.35	133	136	1.0	-3	0	7.9	NAF
AARC 2008	34015	DR346	410	410.5	0.5	Hanging wall slate	205	9.1	1.13	35	32	0.9	3	0	8.5	UC (NAF)
AARC 2008	34159	DR315	84.5	85	0.5	Hanging wall slate	591	8.6	4.11	126	67	0.5	59	0	7.6	UC (PAF)
AARC 2008	34066	DR340	126.5	127	0.5	Hanging wall slate	114	9.2	0.56	17	12	0.7	5	10	3.0	PAF
AARC 2008	34018	DR346	414.5	415	0.5	Hanging wall slate	172	9.2	0.68	21	14	0.7	7	8	2.8	PAF
AARC 2008	34017	DR346	414	414.5	0.5	Hanging wall slate	162	9.3	0.87	27	14	0.5	13	12	2.7	PAF
AARC 2008	34064	DR340	123	123.5	0.5	Hanging wall slate	139	9.4	0.72	22	8	0.3	14	16	2.8	PAF
AARC 2008	34050	DR341	99.5	100	0.5	Hanging wall slate	122	9.5	0.89	27	10	0.4	17	19	2.6	PAF
AARC 2008	34053	DR341	123	123.5	0.5	Hanging wall slate	89	8.8	0.91	28	5	0.2	23	25	2.6	PAF
AARC 2008	34162	DR315	101	101.5	0.5	Hanging wall slate	143	9.4	1.25	38	15	0.4	23	26	3.2	PAF
AARC 2008	34067	DR340	127	127.5	0.5	Hanging wall slate	185	8.2	1.31	40	8	0.2	32	35	2.6	PAF
AARC 2008	34054	DR341	123.5	124	0.5	Hanging wall slate	96	8.7	1.29	39	6	0.1	34	37	2.6	PAF
AARC 2008	34065	DR340	124.7	125.2	0.5	Hanging wall slate	106	9.0	1.3	40	5	0.1	34	33	2.6	PAF
AARC 2008	34158	DR315	84	84.5	0.5	Hanging wall slate	188	9.1	2.27	69	32	0.5	37	38	2.8	PAF
AARC 2008	34161	DR315	90.5	91	0.5	Hanging wall slate	399	8.6	3.24	99	38	0.4	61	55	2.6	PAF
AARC 2008	34160	DR315	90	90.5	0.5	Hanging wall slate	421	8.4	2.64	81	14	0.2	67	54	2.5	PAF
AARC 2008	34069	DR340	130.5	131	0.5	Hanging wall slate	660	8.0	2.57	79	6	0.1	72	68	2.4	PAF
AARC 2008	34011	DR346	402.5	403	0.5	Hanging wall slate	195	8.5	2.76	84	8	0.1	76	73	2.4	PAF
AARC 2008	34164	DR315	102	102.5	0.5	Hanging wall slate	316	8.3	3.69	113	26	0.2	87	80	2.7	PAF
AARC 2008	34016	DR346	410.5	411	0.5	Hanging wall slate	253	8.7	5.64	173	79	0.5	94	56	2.5	PAF
AARC 2008	34068	DR340	130	130.5	0.5	Hanging wall slate	515	8.1	3.55	109	10	0.1	99	90	2.2	PAF
AARC 2008	34040	DR342	376	377.5	1.5	Hanging wall slate	690	8.0	7.64	234	45	0.2	188	138	2.2	PAF
AARC 2008	34012	DR346	403	403.5	0.5	Hanging wall slate	239	7.6	7.18	220	6	0.0	214	144	2.2	PAF
AARC 2008	34013	DR346	403.5	404	0.5	Hanging wall slate	428	8.0	12.3	376	11	0.0	365	204	2.0	PAF
AARC 2008	34163	DR315	101.5	102	0.5	Hanging wall slate	581	8.2	14.4	441	20	0.0	421	198	2.3	PAF

APPENDIX A : Continued

Study	Sample ID	Hole No.	From (m)	To (m)	Interval (m)	Lithology	EC	Existing pH	Total %S	MPA	ANC	ANC/MPA Ratio	NAPP	NAG	NAGpH	ARD Class
AARC 2008	34184	DR319	399	400	1.0	Lode waste	276	9.0	6.87	210	397	2	-187	0	7.6	NAF
AARC 2008	34042	DR342	418.5	419.5	1.0	Lode waste	120	9.5	2.18	67	208	3.1	-141	0	7.9	NAF
AARC 2008	34019	DR346	434.5	435	0.5	Lode waste	260	7.9	1.24	38	7	0.2	31	31	2.7	PAF
AARC 2008	34020	DR346	435.5	436	0.5	Lode waste	139	9.1	1.63	50	10	0.2	40	32	2.6	PAF
AARC 2008	34166	DR315	270.5	271.5	1.0	Lode waste	412	8.1	4.66	143	18	0.1	125	115	2.3	PAF
AARC 2008	34070	DR340	141.5	142.5	1.0	Lode waste	172	8.6	6.75	207	9	0.0	197	133	2.2	PAF
AARC 2008	34173	DR332	414.5	415.4	0.9	Lode waste	270	9.0	8.82	270	11	0.0	259	183	2.2	PAF
AARC 2008	34071	DR340	142.5	143.5	1.0	Lode waste	238	6.7	13.7	419	5	0.0	414	186	2.0	PAF
AARC 2008	34059	DR341	146.5	147.5	1.0	Lode waste	255	8.3	15.4	471	7	0.0	465	215	2.1	PAF
AARC 2008	34058	DR341	137	138	1.0	Lode waste	186	8.5	16.6	508	8	0.0	500	200	2.1	PAF
AARC 2008	34072	DR340	159	159.5	0.5	Footwall slate	334	8.9	0.92	28	148	5.3	-120	0	7.9	NAF
AARC 2008	34075	DR340	160.5	161	0.5	Footwall slate	309	8.8	1.11	34	141	4.2	-107	0	8.2	NAF
AARC 2008	34074	DR340	160	160.5	0.5	Footwall slate	558	8.5	0.98	30	115	3.8	-85	0	8.2	NAF
AARC 2008	34077	DR340	161.5	162	0.5	Footwall slate	138	9.3	1.03	32	113	3.6	-81	0	8.1	NAF
AARC 2008	34061	DR341	157.5	158	0.5	Footwall slate	87	9.4	0.45	14	93	6.8	-79	0	8.2	NAF
AARC 2008	34076	DR340	161	161.5	0.5	Footwall slate	160	9.1	1.01	31	107	3.5	-76	0	8.2	NAF
AARC 2008	34168	DR315	273.2	273.7	0.5	Footwall slate	233	9.2	1.18	36	111	3.1	-75	0	8.5	NAF
AARC 2008	34073	DR340	159.5	160	0.5	Footwall slate	289	8.9	0.67	21	92	4.5	-72	0	8.0	NAF
AARC 2008	34062	DR341	162	162.5	0.5	Footwall slate	103	9.4	0.89	27	89	3.3	-62	0	8.2	NAF
AARC 2008	34167	DR315	272.7	273.2	0.5	Footwall slate	146	9.3	1.2	37	98	2.7	-61	0	8.6	NAF
AARC 2008	34063	DR341	162.5	163	0.5	Footwall slate	97	9.5	0.72	22	76	3.4	-53	0	8.4	NAF
AARC 2008	34060	DR341	157	157.5	0.5	Footwall slate	124	9.4	1.49	46	48	1.0	-2	0	8.1	NAF
AARC 2008	34048	DR342	424	425	1.0	Footwall slate	222	8.9	14.6	447	244	0.5	203	0	8.3	UC (PAF)
AARC 2008	34022	DR346	432.9	433.3	0.4	Footwall slate	134	8.8	1.27	39	12	0.3	27	25	2.3	PAF
AARC 2008	34021	DR346	432.5	432.9	0.4	Footwall slate	220	8.7	1.55	47	11	0.2	37	34	2.6	PAF
AARC 2008	34041	DR342	423	424	1.0	Footwall slate	208	8.6	13.8	422	32	0.1	390	133	2.1	PAF
AARC 2008	34186	DR319	446	446.5	0.5	Footwall limestone	262	9.3	1.27	39	552	14	-513	0	8.7	NAF
AARC 2008	34078	DR340	185	185.5	0.5	Footwall limestone	144	9.4	0.94	29	272	9.5	-243	0	9.0	NAF
AARC 2008	34055	DR341	177	177.5	0.5	Footwall limestone	110	9.4	0.36	11	251	23	-240	0	9.7	NAF
AARC 2008	34057	DR341	183	183.5	0.5	Footwall limestone	115	9.5	0.77	24	244	10	-220	0	9.0	NAF
AARC 2008	34079	DR340	185.5	186	0.5	Footwall limestone	138	9.4	1.21	37	253	6.8	-216	0	8.6	NAF
AARC 2008	34080	DR340	186	186.5	0.5	Footwall limestone	159	9.3	1.34	41	249	6.1	-208	0	9.8	NAF
AARC 2008	34172	DR315	292.5	293	0.5	Footwall limestone	226	9.2	1.76	54	250	4.6	-196	0	8.6	NAF
AARC 2008	34185	DR319	441	441.5	0.5	Footwall limestone	158	9.6	1.07	33	225	7	-192	0	9.6	NAF
AARC 2008	34056	DR341	177.5	178	0.5	Footwall limestone	125	9.4	1.92	59	241	4.1	-182	0	8.9	NAF
AARC 2008	34043	DR342	458	458.5	0.5	Footwall limestone	106	9.7	1.01	31	178	5.8	-147	0	8.7	NAF
AARC 2008	34025	DR346	496	496.5	0.5	Footwall limestone	143	9.4	1.25	38	180	5	-142	0	8.3	NAF
AARC 2008	34045	DR342	471	471.5	0.5	Footwall limestone	109	9.7	1.15	35	166	4.7	-131	0	8.3	NAF

APPENDIX A : Continued

Study	Sample ID	Hole No.	From (m)	To (m)	Interval (m)	Lithology	EC	Existing pH	Total %S	MPA	ANC	ANC/MPA Ratio	NAPP	NAG	NAGpH	ARD Class
AARC 2008	37335	DR342	460.1	460.4	0.3	Footwall limestone	168	9.6	0.76	23	142	6.1	-119	0	9.0	NAF
AARC 2008	34171	DR315	292	292.5	0.5	Footwall limestone	186	9.4	1.66	51	153	3.0	-102	0	8.7	NAF
AARC 2008	34170	DR315	281.5	282	0.5	Footwall limestone	234	9.3	1.09	33	116	3.5	-83	0	8.4	NAF
AARC 2008	34024	DR346	492	492.5	0.5	Footwall limestone	126	9.5	0.46	14	89	6	-75	0	8.6	NAF
AARC 2008	34023	DR346	490.5	491	0.5	Footwall limestone	144	9.4	0.63	19	89	5	-70	0	8.9	NAF
AARC 2008	34169	DR315	281	281.5	0.5	Footwall limestone	182	9.4	1.35	41	93	2.3	-52	0	8.6	NAF

# Appendix B

## **Multi-Element Data and Geochemical Abundance Indices for Drill Core Samples from Previous Geochemical Studies of Dugald River Waste Rock**

AGC-Woodward Clyde (1991)  
AustralAsian Resource Consultants (2008)



**APPENDIX B-1: Multi-element data for drill core samples from previous geochemical studies of Dugald River waste rock**

Study	Sample ID	Hole No.	From (m)	To (m)	Lithology	ARD Class	As (mg/kg)	Ba (mg/kg)	Be (mg/kg)	Cd (mg/kg)	Co (mg/kg)	Cr (mg/kg)	Cu (mg/kg)	Hg (mg/kg)	Mn (mg/kg)	Ni (mg/kg)	Pb (mg/kg)	S (%)	Sb (mg/kg)	V (mg/kg)	Zn (mg/kg)
AGC-WWC 1991	-	229	700	701	Hanging wall slate	NAF	46	-	-	1	10	-	10	0.05	-	-	120	0.4%	5	-	470
AGC-WWC 1991	-	174	168	169	Hanging wall slate	NAF	80	-	-	1	5	-	250	0.1	-	-	250	1.7%	5	-	670
AGC-WWC 1991	-	230	662	663	Hanging wall slate	PAF	18	-	-	1	30	-	1650	0.05	-	-	25	1.3%	5	-	220
AGC-WWC 1991	-	230	675	676	Hanging wall slate	PAF	85	-	-	1	10	-	90	0.1	-	-	310	2.9%	5	-	1250
AGC-WWC 1991	-	186	672	673	Hanging wall slate	PAF	75	-	-	2	45	-	250	0.1	-	-	230	5.2%	5	-	640
AGC-WWC 1991	-	231	491	492	Hanging wall slate	PAF	19	-	-	1	25	-	250	0.05	-	-	45	6.8%	5	-	95
AGC-WWC 1991	-	174	171	172	Lode ore	PAF	65	-	-	240	30	-	470	4.4	-	-	1.52%	15.3%	25	-	11.9%
AGC-WWC 1991	-	186	684	685	Lode ore	PAF	450	-	-	330	15	-	195	5.3	-	-	6.84%	14.5%	140	-	13.8%
AGC-WWC 1991	-	229	720	721	Lode ore	PAF	65	-	-	125	5	-	145	1.45	-	-	1.78%	12.2%	5	-	8.8%
AGC-WWC 1991	-	231	500	501	Lode ore	PAF	520	-	-	210	30	-	70	2	-	-	5200	16.3%	5	-	8.4%
AGC-WWC 1991	-	230	684	685	Lode ore	PAF	210	-	-	290	20	-	85	2	-	-	3.24%	20.1%	5	-	14.6%
AGC-WWC 1991	-	186	696	697	Footwall slate	NAF	36	-	-	8	5	-	25	0.1	-	-	220	1.1%	5	-	3950
AGC-WWC 1991	-	230	703	704	Footwall slate	NAF	100	-	-	1	5	-	25	0.05	-	-	45	0.5%	5	-	490
AGC-WWC 1991	-	231	540	541	Footwall slate	NAF	24	-	-	1	5	-	25	0.05	-	-	30	0.7%	5	-	510
AGC-WWC 1991	-	229	747	748	Footwall slate	NAF	230	-	-	12	10	-	60	0.15	-	-	110	3.9%	5	-	1600
AGC-WWC 1991	-	174	180	181	Footwall slate	NAF	18	-	-	1	5	-	115	0.1	-	-	60	1.6%	5	-	730
AGC-WWC 1991	-	231	508	509	Footwall slate	NAF	155	-	-	44	15	-	30	0.55	-	-	175	3.7%	5	-	2.6%
AGC-WWC 1991	-	217	1029	1030	Footwall slate	PAF	60	-	-	6	5	-	65	0.15	-	-	420	2.2%	5	-	3800
AGC-WWC 1991	-	202	792	793	Footwall slate	PAF	210	-	-	14	25	-	45	1.5	-	-	1150	7.4%	5	-	2.8%
AGC-WWC 1991	-	186	824	825	Footwall limestone	NAF	38	-	-	1	5	-	40	0.05	-	-	110	1.0%	5	-	330
AGC-WWC 1991	-	174	185	186	Footwall limestone	NAF	105	-	-	1	20	-	95	0.05	-	-	45	2.1%	5	-	350
AGC-WWC 1991	-	217	1040	1041	Footwall limestone	NAF	85	-	-	1	10	-	50	0.05	-	-	80	0.8%	5	-	250
AGC-WWC 1991	-	230	760	761	Footwall limestone	PAF	12	-	-	1	10	-	40	0.05	-	-	85	0.9%	5	-	400

\* Note: Samples in the AGC-Woodward Clyde (1991) study were also assayed for bismuth but the concentrations in all samples were at or below the analytical detection limit of 5 mg/kg.

As the detection limit was particularly high in comparison to typical soil values, the bismuth assay results were not considered in the current review.

APPENDIX B-1 : Continued

Study	Sample ID	Hole No.	From (m)	To (m)	Lithology	ARD Class	As (mg/kg)	Ba (mg/kg)	Be (mg/kg)	Cd (mg/kg)	Co (mg/kg)	Cr (mg/kg)	Cu (mg/kg)	Hg (mg/kg)	Mn (mg/kg)	Ni (mg/kg)	Pb (mg/kg)	S (%)	Sb (mg/kg)	V (mg/kg)	Zn (mg/kg)
AARC 2008	34009	DR346	140	140.5	Calc-silicate	NAF	5	60	2	1	15	37	5	0.1	596	28	5	0.02%	-	43	16
AARC 2008	34027	DR342	106.5	107	Calc-silicate	NAF	5	130	1	1	9	28	5	0.1	740	24	5	0.03%	-	42	5
AARC 2008	34174	DR320	112	112.5	Calc-silicate	NAF	5	40	1	1	2	8	9	0.1	694	12	18	0.1%	-	15	162
AARC 2008	34180	DR319	121	121.5	Calc-silicate	NAF	5	<10	1	1	2	10	7	0.1	1900	5	5	0.01%	-	6	5
AARC 2008	34182	DR319	124	124.5	Calc-silicate	NAF	9	180	1	1	2	7	5	0.1	594	4	5	0.01%	-	12	5
AARC 2008	34188	DR322	129	129.5	Calc-silicate	NAF	5	30	1	1	14	27	5	0.1	1560	19	5	0.04%	-	35	108
AARC 2008	34192	DR321	163	163.5	Calc-silicate	NAF	5	300	2	1	13	36	5	0.1	1710	22	5	0.01%	-	37	15
AARC 2008	34194	DR321	177	177.5	Calc-silicate	NAF	5	360	2	1	20	62	5	0.1	1230	37	5	0.01%	-	86	28
AARC 2008	34196	DR318	219	219.5	Calc-silicate	NAF	5	90	1	1	12	28	6	0.1	1220	25	5	0.03%	-	46	17
AARC 2008	34198	DR318	225	225.5	Calc-silicate	NAF	5	80	2	1	10	24	5	0.1	918	20	5	0.01%	-	41	6
AARC 2008	34200	DR318	227.45	228	Calc-silicate	NAF	5	40	2	1	16	42	6	0.1	1140	28	5	0.02%	-	55	8
AARC 2008	34029	DR342	151.5	152	Mafic feldspar porphyry	NAF	5	270	1	1	25	9	36	0.1	1200	28	5	0.01%	-	104	5
AARC 2008	34031	DR342	260.5	261	White mica schist	NAF	5	110	1	1	38	94	23	0.1	229	18	5	0.02%	-	82	5
AARC 2008	34047	DR342	273	273.5	White mica schist	NAF	5	110	1	1	6	53	16	0.1	215	18	5	0.03%	-	31	5
AARC 2008	34176	DR320	212	212.5	White mica schist	NAF	5	90	1	1	16	31	106	0.1	679	29	5	0.02%	-	46	18
AARC 2008	34178	DR320	216	216.5	White mica schist	NAF	5	120	1	1	15	31	23	0.1	1070	29	5	0.01%	-	59	13
AARC 2008	34202	DR316	266	266.5	White mica schist	NAF	5	100	3	1	17	28	64	0.1	553	30	5	0.02%	-	37	11
AARC 2008	34204	DR316	270	270.5	White mica schist	NAF	5	140	1	1	17	30	5	0.1	510	30	5	0.01%	-	43	19
AARC 2008	34033	DR342	362.5	363	Hanging wall slate	NAF	5	60	2	1	62	28	399	0.1	1270	24	7	4.1%	-	49	14
AARC 2008	34035	DR342	363.5	364	Hanging wall slate	NAF	5	60	2	1	19	38	689	0.1	1160	14	5	2.3%	-	57	116
AARC 2008	34037	DR342	364.5	365	Hanging wall slate	NAF	5	60	1	1	53	39	1040	0.1	1290	27	7	5.4%	-	71	175
AARC 2008	34039	DR342	365.5	366	Hanging wall slate	NAF	5	20	2	1	19	35	358	0.1	834	16	10	1.9%	-	54	84
AARC 2008	34049	DR341	99	99.5	Hanging wall slate	NAF	9	80	1	1	4	65	60	0.1	562	10	5	0.8%	-	43	14
AARC 2008	34051	DR341	111	111.5	Hanging wall slate	NAF	8	20	1	1	6	23	10	0.1	187	19	5	0.5%	-	5	11
AARC 2008	34190	DR322	157	157.5	Hanging wall slate	NAF	5	70	1	1	10	49	20	0.1	588	18	5	0.07%	-	62	28
AARC 2008	34011	DR346	402.5	403	Hanging wall slate	PAF	44	20	1	5	5	4	57	0.8	320	22	27	2.8%	-	5	4870
AARC 2008	34013	DR346	403.5	404	Hanging wall slate	PAF	188	20	2	2	42	8	225	0.4	741	78	68	12.3%	-	13	2780
AARC 2008	34017	DR346	414	414.5	Hanging wall slate	PAF	5	80	2	1	14	32	260	0.1	603	17	20	0.9%	-	55	43
AARC 2008	34053	DR341	123	123.5	Hanging wall slate	PAF	36	30	1	1	5	27	26	0.1	89	10	6	0.9%	-	8	42
AARC 2008	34065	DR340	124.7	125.2	Hanging wall slate	PAF	41	40	1	1	13	34	13	0.1	330	25	9	1.3%	-	75	46
AARC 2008	34067	DR340	127	127.5	Hanging wall slate	PAF	174	30	1	1	6	13	5	0.1	160	19	5	1.3%	-	11	10
AARC 2008	34069	DR340	130.5	131	Hanging wall slate	PAF	1190	60	1	1	20	4	31	0.1	107	41	18	2.6%	-	10	14
AARC 2008	34158	DR315	84	84.5	Hanging wall slate	PAF	69	20	1	9	29	33	632	0.4	518	45	22	2.3%	-	79	5360
AARC 2008	34160	DR315	90	90.5	Hanging wall slate	PAF	250	20	1	7	21	58	1770	0.5	316	53	6	2.6%	-	107	4350
AARC 2008	34162	DR315	101	101.5	Hanging wall slate	PAF	519	30	1	15	10	39	403	1.3	372	13	22	1.3%	-	104	1.1%
AARC 2008	34164	DR315	102	102.5	Hanging wall slate	PAF	108	20	1	32	10	32	514	2.3	498	27	23	3.7%	-	100	27100
AARC 2008	34015	DR346	410	410.5	Hanging wall slate	UC	6	60	1	1	41	41	652	0.1	328	61	23	1.1%	-	71	125

APPENDIX B-1 : Continued

Study	Sample ID	Hole No.	From (m)	To (m)	Lithology	ARD Class	As (mg/kg)	Ba (mg/kg)	Be (mg/kg)	Cd (mg/kg)	Co (mg/kg)	Cr (mg/kg)	Cu (mg/kg)	Hg (mg/kg)	Mn (mg/kg)	Ni (mg/kg)	Pb (mg/kg)	S (%)	Sb (mg/kg)	V (mg/kg)	Zn (mg/kg)
AARC 2008	34184	DR319	399	400	Lode (mineralised waste)	NAF	21	340	<u>1</u>	66	6	7	87	4.6	10300	18	128	6.9%	-	13	4.4%
AARC 2008	34059	DR341	146.5	147.5	Lode (mineralised waste)	PAF	246	80	<u>1</u>	38	25	44	209	2.2	219	32	197	15.4%	-	34	7.7%
AARC 2008	34071	DR340	142.5	143.5	Lode (mineralised waste)	PAF	304	20	<u>1</u>	52	29	3	95	1	1470	20	649	13.7%	-	8	4.4%
AARC 2008	34166	DR315	270.5	271.5	Lode (mineralised waste)	PAF	12	130	<u>1</u>	12	5	18	323	0.4	932	26	169	4.7%	-	69	6660
AARC 2008	34061	DR341	157.5	158	Footwall slate	NAF	29	50	1	<u>1</u>	2	66	8	<u>0.1</u>	3270	8	48	0.5%	-	31	203
AARC 2008	34063	DR341	162.5	163	Footwall slate	NAF	12	70	1	<u>1</u>	4	65	12	<u>0.1</u>	1970	11	21	0.7%	-	36	68
AARC 2008	34073	DR340	159.5	160	Footwall slate	NAF	36	50	<u>1</u>	<u>1</u>	3	7	7	<u>0.1</u>	2020	10	27	0.7%	-	7	333
AARC 2008	34075	DR340	160.5	161	Footwall slate	NAF	116	40	2	5	8	24	15	0.1	2540	22	38	1.1%	-	30	2830
AARC 2008	34077	DR340	161.5	162	Footwall slate	NAF	67	320	1	<u>1</u>	8	26	19	<u>0.1</u>	2390	19	185	1.0%	-	30	345
AARC 2008	34168	DR315	273.2	273.7	Footwall slate	NAF	23	200	1	<u>1</u>	6	31	50	<u>0.1</u>	1710	14	61	1.2%	-	43	218
AARC 2008	34170	DR315	281.5	282	Footwall slate	NAF	5	180	1	<u>1</u>	6	35	28	<u>0.1</u>	2480	19	18	1.1%	-	45	156
AARC 2008	34172	DR315	292.5	293	Footwall slate	NAF	22	60	<u>1</u>	1	10	7	25	0.1	944	16	73	1.8%	-	11	387
AARC 2008	34019	DR346	434.5	435	Footwall slate	PAF	26	120	3	<u>1</u>	6	8	158	<u>0.1</u>	394	14	48	1.2%	-	17	74
AARC 2008	34021	DR346	432.5	432.9	Footwall slate	PAF	<u>5</u>	70	<u>1</u>	<u>1</u>	4	2	36	<u>0.1</u>	147	13	33	1.6%	-	<u>5</u>	19
AARC 2008	34041	DR342	423	424	Footwall slate	PAF	1070	70	<u>1</u>	<u>1</u>	69	60	673	0.4	153	24	168	13.8%	-	39	197
AARC 2008	34023	DR346	490.5	491	Footwall limestone	NAF	9	150	2	<u>1</u>	4	39	127	<u>0.1</u>	1280	12	18	0.6%	-	63	65
AARC 2008	34025	DR346	496	496.5	Footwall limestone	NAF	183	100	1	<u>1</u>	6	28	335	<u>0.1</u>	2540	21	14	1.3%	-	43	47
AARC 2008	34043	DR342	458	458.5	Footwall limestone	NAF	14	90	2	<u>1</u>	10	34	110	<u>0.1</u>	3610	21	27	1.0%	-	37	42
AARC 2008	34045	DR342	471	471.5	Footwall limestone	NAF	<u>5</u>	70	1	<u>1</u>	8	28	191	<u>0.1</u>	2440	22	61	1.2%	-	27	29
AARC 2008	34055	DR341	177	177.5	Footwall limestone	NAF	7	30	<u>1</u>	<u>1</u>	3	13	7	<u>0.1</u>	915	5	43	0.4%	-	6	60
AARC 2008	34057	DR341	183	183.5	Footwall limestone	NAF	9	20	<u>1</u>	3	4	12	19	<u>0.1</u>	1130	8	67	0.8%	-	6	1250
AARC 2008	34079	DR340	185.5	186	Footwall limestone	NAF	16	70	<u>1</u>	<u>1</u>	5	6	14	<u>0.1</u>	787	11	44	1.2%	-	10	129
AARC 2008	34186	DR319	446	446.5	Footwall limestone	NAF	9	70	<u>1</u>	3	4	6	17	0.2	1330	10	77	1.3%	-	10	1800

\* underlined values indicate concentration less than the analytical detection limit



APPENDIX B-2: Continued

Element	Lode Waste				Footwall slate														Footwall limestone										Median Soil Content										
	DR319 (399-400m)	DR341 (146.5-147.5m)	DR340 (142.5-143.5m)	DR315 (270.5-271.5m)	DR341 (157.5-158m)	DR341 (162.5-163m)	DR340 (159.5-160m)	DR340 (160.5-161m)	DR340 (161.5-162m)	DR315 (273.2-273.7m)	DR315 (281.5-282m)	DR315 (292.5-293m)	186 (696-697m)	230 (703-704m)	231 (540-541m)	229 (747-748m)	174 (180-181m)	231 (508-509m)	DR346 (434.5-435m)	DR346 (432.5-432.9m)	DR342 (423-424m)	217 (1029-1030m)	202 (792-793m)	DR346 (490.5-491m)	DR346 (496-496.5m)	DR342 (468-468.5m)	DR342 (471-471.5m)	DR341 (177-177.5m)		DR341 (183-183.5m)	DR340 (185.5-186m)	DR319 (446-446.5m)	186 (824-825m)	174 (185-186m)	217 (1040-1041m)	230 (760-761m)			
	NAF	PAF	PAF	PAF	NAF	NAF	NAF	NAF	NAF	NAF	NAF	NAF	NAF	NAF	NAF	NAF	NAF	NAF	PAF	PAF	PAF	PAF	PAF	NAF	NAF	NAF	NAF	NAF		NAF	NAF	NAF	NAF	NAF	NAF	NAF	PAF		
As (mg/kg)	1	4	5	0	1	0	2	3	2	1	0	1	2	3	1	4	1	4	1	0	6	2	4	0	4	0	0	0	0	0	0	0	2	3	3	0	6 mg/kg		
Ba (mg/kg)	0	0	0	0	0	0	0	0	0	0	0	0	-	-	-	-	-	-	0	0	0	-	-	0	0	0	0	0	0	0	0	0	-	-	-	-	500 mg/kg		
Be (mg/kg)	0	0	0	0	0	0	0	0	0	0	0	0	-	-	-	-	-	-	0	0	0	-	-	0	0	0	0	0	0	0	0	0	0	-	-	-	-	6 mg/kg	
Cd (mg/kg)	6	6	6	4	0	0	0	3	0	0	0	0	3	0	0	4	0	6	0	0	0	3	4	0	0	0	0	0	0	2	0	2	0	0	0	0	0	0.4 mg/kg	
Co (mg/kg)	0	1	1	0	0	0	0	0	0	0	0	0	0	0	0	0	0	0	0	0	2	0	1	0	0	0	0	0	0	0	0	0	0	0	0	0	0	8 mg/kg	
Cr (mg/kg)	0	0	0	0	0	0	0	0	0	0	0	0	-	-	-	-	-	-	0	0	0	-	-	0	0	0	0	0	0	0	0	0	0	0	-	-	-	-	70 mg/kg
Cu (mg/kg)	0	2	1	2	0	0	0	0	0	0	0	0	0	0	0	1	0	1	0	3	0	0	0	1	2	1	2	0	0	0	0	0	0	0	1	0	0	30 mg/kg	
Hg (mg/kg)	5	4	3	2	0	0	0	0	0	0	0	0	0	0	0	0	2	0	0	2	0	4	0	0	0	0	0	0	0	0	0	1	0	0	0	0	0.06 mg/kg		
Mn (mg/kg)	2	0	0	0	1	0	0	0	0	0	0	0	-	-	-	-	-	-	0	0	0	-	-	0	0	1	0	0	0	0	0	0	-	-	-	-	1000 mg/kg		
Ni (mg/kg)	0	0	0	0	0	0	0	0	0	0	0	0	-	-	-	-	-	-	0	0	0	-	-	0	0	0	0	0	0	0	0	0	0	-	-	-	-	50 mg/kg	
Pb (mg/kg)	1	1	3	1	0	0	0	0	1	0	0	0	2	0	0	1	0	1	0	0	1	3	4	0	0	0	0	0	0	0	0	0	0	1	0	0	0	35 mg/kg	
S (%)	6	6	6	5	2	2	2	3	3	3	3	4	3	2	2	5	3	5	3	3	6	4	6	2	3	3	3	3	1	2	3	3	3	4	3	3	0.07 %		
Sb (mg/kg)	-	-	-	-	-	-	-	-	-	-	-	-	0	0	0	0	0	0	-	-	-	0	0	-	-	-	-	-	-	-	-	-	0	0	0	0	5 mg/kg		
V (mg/kg)	0	0	0	0	0	0	0	0	0	0	0	0	-	-	-	-	-	-	0	0	0	-	-	0	0	0	0	0	0	0	0	0	-	-	-	-	90 mg/kg		
Zn (mg/kg)	6	6	6	6	0	0	1	4	1	0	0	1	4	1	1	3	2	6	0	0	0	4	6	0	0	0	0	0	0	3	0	3	1	1	0	1	90 mg/kg		

# Appendix C

## Results of Column Leach Tests Involving Dugald River Waste Rock

AustralAsian Resource Consultants (2008)

**APPENDIX C-1: Results of column leach tests involving Dugald River waste rock - Acid forming characteristics of column leach samples**

Parameter	Unit	Column 1	Column 2	Column 3	Column 4	Column 5	Column 6	Column 7
		HW Slate	Footwall Limestone	PAF Mixture	Footwall Slate	HW Calc-silicate	Calc-silicate & Porphyry	Mica Schist
Existing pH		8.6	9.3	8.8	9.0	9.4	9.4	9.6
EC	μS/cm	343	206	350	278	131	171	110
Total S	(%S)	2.39	0.56	9.47	0.96	0.03	0.02	0.05
MPA	kg H2SO4/t	73	17	290	29	1	1	2
ANC	kg H2SO4/t	71	222	35.6	112	180	197	80.3
NAPP	kg H2SO4/t	2	-205	254	-83	-179	-196	-79
NAG	kg H2SO4/t	0	0	161	0	0	0	0
NAGpH		8.5	10.7	1.9	8.4	11.5	11.8	11.7
ARD Class		UC	NAF	PAF	NAF	NAF	NAF	NAF





**APPENDIX C-3: Results of column leach tests involving Dugald River waste rock - Leachate composition for FW Limestone (Column 2)**

Parameter	Collection Date and Duration of Leaching (days)																	
	19-Aug-08	16-Sep-08	15-Oct-08	11-Nov-08	9-Dec-08	12-Jan-09	3-Feb-09	5-Mar-09	31-Mar-09	28-Apr-09	26-May-09	23-Jun-09	22-Jul-09	18-Aug-09	15-Sep-09	13-Oct-09	10-Nov-09	1-Dec-09
	0	4	8	12	16	20	24	28	32	36	40	44	48	52	56	60	64	68
pH	8.89	8.79	8.54	8.33	7.5	7.76	8.03	6.23	7.56	6.55	7.35	7.91						
EC	177	173	170	140	180	149	162	122	149	144	137	72						
Alk	21	128	22	24	23	31	21	23	20	17	13	11						
Acy	<1	<1	<1	<1	<1	6	6	<1	2	2	2	4						
SO4	47	52	56	36	68	38	53	44	34	41	42	18						
Si	0.22		0.36		0.21		0.23		0.14		0.13							
Cl	2		6		<1		2		8		<1							
Ca	11		18		23		18		16		16							
Mg	1		3		4		4		2		3							
Na	16		10		9		5		2		2							
K	2		3		3		2		2		2							
Al	0.11		0.03		0.03		0.02		0.02		0.02							
Sb	0.001		0.001		0.001		<0.001		<0.001		<0.001							
As	0.001		0.001		<0.001		<0.001		0.001		<0.001							
Be	<0.001		<0.001		<0.001		<0.001		<0.001		<0.001							
Ba	0.025		0.012		0.014		0.01		0.013		0.007							
Cd	<0.0001		<0.0001		0.0002		<0.0001		0.0001		<0.0001							
Cr	<0.001		<0.001		<0.001		<0.001		<0.001		<0.001							
Co	<0.001		<0.001		<0.001		<0.001		<0.001		<0.001							
Cu	0.002		<0.001		0.001		0.001		<0.001		<0.001							
Pb	<0.001		<0.001		<0.001		<0.001		<0.001		<0.001							
Mn	0.042		0.02		0.037		0.015		0.021		0.013							
Mo	<0.001		0.003		0.002		0.002		0.001		0.001							
Ni	0.001		<0.001		<0.001		<0.001		<0.001		<0.001							
Se	<0.010		<0.010		<0.010		<0.01		<0.01		<0.01							
Ag	<0.001		<0.001		<0.001		<0.001		<0.001		<0.001							
Sr	0.072		0.091		0.089		0.062		0.045		0.044							
Th	<0.001		<0.001		<0.001		<0.001		<0.001		<0.001							
Sn	<0.001		<0.001		<0.001		<0.001		<0.001		<0.001							
U	<0.001		<0.001		<0.001		<0.001		<0.001		<0.001							
Zn	<0.005		0.012		0.019		0.007		0.09		<0.005							
B	<0.05		<0.05		<0.05		<0.05		<0.05		<0.05							
Fe	<0.05		<0.05		<0.05		0.07		<0.05		<0.05							
Hg	0.0003		<0.0001		<0.0001		<0.0001		<0.0001		<0.0001							
SiO2	0.5		0.8		0.4		0.5		0.3		0.3							
F	0.2		0.2		0.2		0.1		<0.1		0.1							

**APPENDIX C-4: Results of column leach tests involving Dugald River waste rock - Leachate composition for PAF Rock Mixture (Column 3)**

Parameter	Collection Date and Duration of Leaching (days)																	
	19-Aug-08	16-Sep-08	15-Oct-08	11-Nov-08	9-Dec-08	12-Jan-09	3-Feb-09	5-Mar-09	31-Mar-09	28-Apr-09	26-May-09	23-Jun-09	22-Jul-09	18-Aug-09	15-Sep-09	13-Oct-09	10-Nov-09	1-Dec-09
	0	4	8	12	16	20	24	28	32	36	40	44	48	52	56	60	64	68
pH	7.23	7.48	7.12	7.59	6.41	6.64	5.59	4.99	6.03	5.67	5.24	5.19	4.62	5.17	5.49	4.78	4.52	4.45
EC	241	160	124	173	216	269	247	255	237	230	238	272	453	231	266	233	233	297
Alk	20	20	20	22	4	4	4	4	28	3	1	3	<1	<1	<1	2	<1	<1
Acy	<1	<1	2	2	15	20	26	33	18	22	18	15	64	24	47	35	51	63
SO4	82	50	42	57	105	106	100	139	76	98	85	115	170	96	128	98	103	129
Si	0.1		0.08		0.07		0.09		0.08		0.1		0.11		0.12		0.07	
Cl	<1		<1		<1		3		<1		<1		1		2		<1	
Ca	23		16		25		21		19		18		18		18		12	
Mg	3		2		8		8		8		8		19		12		8	
Na	10		3		4		3		1		1		1		1		2	
K	4		2		2		2		<1		<1		<1		<1		<1	
Al	0.04		0.02		0.09		0.14		0.08		0.16		0.47		0.36		0.37	
Sb	<0.001		<0.001		<0.001		<0.001		<0.001		<0.001		<0.001		<0.001		<0.001	
As	<0.001		<0.001		<0.001		<0.001		<0.001		<0.001		<0.001		<0.001		<0.001	
Be	<0.001		<0.001		<0.001		<0.001		<0.001		<0.001		<0.001		<0.001		<0.001	
Ba	0.018		0.011		0.023		0.01		0.01		0.008		0.006		0.006		0.004	
Cd	0.0002		0.0003		0.0021		0.0031		0.0037		0.0045		0.009		0.0089		0.0084	
Cr	<0.001		<0.001		<0.001		<0.001		<0.001		<0.001		<0.001		<0.001		<0.001	
Co	0.003		0.003		0.014		0.016		0.014		0.012		0.036		0.02		0.02	
Cu	0.001		<0.001		0.004		0.003		0.002		0.006		0.019		0.026		0.031	
Pb	<0.001		0.003		0.014		0.019		0.008		0.016		0.018		0.028		0.031	
Mn	0.829		0.406		1.99		2.23		2.24		2.02		6.27		3.24		2.81	
Mo	<0.001		<0.001		<0.001		<0.001		<0.001		<0.001		<0.001		<0.001		<0.001	
Ni	0.01		0.01		0.052		0.056		0.051		0.05		0.14		0.075		0.074	
Se	<0.010		<0.010		<0.010		<0.01		<0.01		<0.01		<0.01		<0.01		<0.01	
Ag	<0.001		<0.001		<0.001		<0.001		<0.001		<0.001		<0.001		<0.001		<0.001	
Sr	0.07		0.032		0.041		0.032		0.022		0.024		0.026		0.023		0.015	
Th	<0.001		<0.001		<0.001		<0.001		<0.001		<0.001		<0.001		<0.001		<0.001	
Sn	0.001		<0.001		<0.001		<0.001		<0.001		<0.001		<0.001		<0.001		<0.001	
U	<0.001		<0.001		0.003		0.005		0.002		0.004		0.008		0.007		0.008	
Zn	0.102		0.339		2.03		3.02		3.35		3.94		9.41		7.21		6.79	
B	<0.05		<0.05		<0.05		<0.05		<0.05		<0.05		<0.05		<0.05		<0.05	
Fe	<0.05		0.46		4.18		9.89		6.76		7.68		18.1		12.4		15.4	
Hg	0.0004		<0.0001		<0.0001		<0.0001		<0.0001		<0.0001		<0.0001		<0.0001		<0.0001	
SiO2	0.2		0.2		0.1		0.2		0.2		0.2		0.2		0.2		0.1	
F	0.2		0.2		0.3		0.2		<0.1		0.1		0.4		0.2		0.2	

**APPENDIX C-5: Results of column leach tests involving Dugald River waste rock - Leachate composition for FW Slate (Column 4)**

Parameter	Collection Date and Duration of Leaching (days)																	
	19-Aug-08	16-Sep-08	15-Oct-08	11-Nov-08	9-Dec-08	12-Jan-09	3-Feb-09	5-Mar-09	31-Mar-09	28-Apr-09	26-May-09	23-Jun-09	22-Jul-09	18-Aug-09	15-Sep-09	13-Oct-09	10-Nov-09	1-Dec-09
	0	4	8	12	16	20	24	28	32	36	40	44	48	52	56	60	64	68
pH	8.42	8.1	7.8	8.11	6.86	8.11	7.82	7.08	7.27	7.82	6.67	6.78						
EC	176	161	113	126	137	172	137	133	178	132	136	136						
Alk	12	15	23	82	14	21	22	16	16	9	13	10						
Acy	<1	<1	2	<1	2	2	4	12	12	2	2	2						
SO4	53	50	32	33	52	54	46	54	51	43	42	44						
Si	0.16		0.08		<0.05		0.07		0.11		0.07							
Cl	<1		4		<1		1		<1		<1							
Ca	18		15		19		19		19		18							
Mg	3		2		4		3		4		3							
Na	5		2		2		2		1		1							
K	3		2		2		2		1		1							
Al	0.06		0.03		0.03		0.02		0.04		0.02							
Sb	<0.001		<0.001		<0.001		<0.001		<0.001		<0.001							
As	<0.001		<0.001		<0.001		<0.001		<0.001		<0.001							
Be	<0.001		<0.001		<0.001		<0.001		<0.001		<0.001							
Ba	0.012		0.004		0.006		0.004		0.006		0.004							
Cd	<0.0001		<0.0001		<0.0001		<0.0001		0.0002		<0.0001							
Cr	<0.001		<0.001		<0.001		<0.001		<0.001		<0.001							
Co	<0.001		<0.001		<0.001		<0.001		<0.001		<0.001							
Cu	<0.001		<0.001		0.002		<0.001		<0.001		<0.001							
Pb	<0.001		<0.001		<0.001		<0.001		<0.001		<0.001							
Mn	0.216		0.184		0.308		0.232		0.354		0.149							
Mo	<0.001		<0.001		<0.001		<0.001		<0.001		<0.001							
Ni	0.002		<0.001		0.002		0.001		<0.001		<0.001							
Se	<0.010		<0.010		<0.010		<0.01		<0.01		<0.01							
Ag	<0.001		<0.001		<0.001		<0.001		<0.001		<0.001							
Sr	0.025		0.015		0.018		0.014		0.013		0.012							
Th	<0.001		<0.001		<0.001		<0.001		<0.001		<0.001							
Sn	0.001		<0.001		<0.001		<0.001		<0.001		<0.001							
U	<0.001		<0.001		<0.001		<0.001		<0.001		<0.001							
Zn	<0.005		<0.005		0.017		0.007		0.043		0.007							
B	<0.05		<0.05		<0.05		<0.05		<0.05		<0.05							
Fe	<0.05		<0.05		0.17		<0.05		<0.05		0.05							
Hg	0.0004		<0.0001		<0.0001		<0.0001		<0.0001		<0.0001							
SiO2	0.4		0.2		<0.1		0.1		0.2		0.1							
F	0.2		0.1		0.1		0.1		<0.1		<0.1							

**APPENDIX C-6: Results of column leach tests involving Dugald River waste rock - Leachate composition for HW Calc-Silicate (Column 5)**

Parameter	Collection Date and Duration of Leaching (days)																	
	19-Aug-08	16-Sep-08	15-Oct-08	11-Nov-08	9-Dec-08	12-Jan-09	3-Feb-09	5-Mar-09	31-Mar-09	28-Apr-09	26-May-09	23-Jun-09	22-Jul-09	18-Aug-09	15-Sep-09	13-Oct-09	10-Nov-09	1-Dec-09
	0	4	8	12	16	20	24	28	32	36	40	44	48	52	56	60	64	68
pH	9.07	9.07	9.16	9.25	8.51	8.57	9.28	7.23	8.45	8.16	8.81	9.00						
EC	83	87	75	61	61	88	64	55	63	57	57	50						
Alk	36	214	38	116	25	66	24	27	27	22	31	22						
Acy	<1	<1	<1	<1	<1	4	<1	<1	<1	<1	<1	2						
SO4	8	9	5	3	6	7	8	5	10	6	5	4						
Si	0.74		0.68		0.39		0.43		0.44		0.33							
Cl	2		4		<1		2		3		<1							
Ca	7		7		7		6		5		8							
Mg	<1		<1		<1		<1		2		<1							
Na	9		6		4		5		13		3							
K	1		1		<1		1		1		<1							
Al	0.17		0.08		0.07		0.05		0.12		0.05							
Sb	<0.001		<0.001		<0.001		<0.001		<0.001		<0.001							
As	<0.001		<0.001		0.002		<0.001		<0.001		<0.001							
Be	<0.001		<0.001		<0.001		<0.001		<0.001		<0.001							
Ba	0.004		0.004		0.004		0.005		0.007		0.004							
Cd	<0.0001		<0.0001		<0.0001		<0.0001		0.0002		<0.0001							
Cr	<0.001		<0.001		<0.001		<0.001		<0.001		<0.001							
Co	<0.001		<0.001		<0.001		<0.001		<0.001		<0.001							
Cu	<0.001		<0.001		0.002		<0.001		<0.001		<0.001							
Pb	<0.001		<0.001		<0.001		<0.001		<0.001		<0.001							
Mn	0.012		0.005		0.018		0.007		0.008		0.007							
Mo	0.024		0.017		0.009		0.012		0.006		0.007							
Ni	<0.001		<0.001		<0.001		<0.001		<0.001		<0.001							
Se	<0.010		<0.010		<0.010		<0.01		<0.01		<0.01							
Ag	<0.001		<0.001		<0.001		<0.001		<0.001		<0.001							
Sr	0.013		0.01		0.01		0.01		0.007		0.007							
Th	<0.001		<0.001		<0.001		<0.001		<0.001		<0.001							
Sn	<0.001		<0.001		<0.001		<0.001		<0.001		<0.001							
U	0.002		0.003		0.002		0.003		0.002		0.001							
Zn	<0.005		<0.005		<0.005		<0.005		0.062		<0.005							
B	<0.05		<0.05		<0.05		<0.05		<0.05		<0.05							
Fe	<0.05		<0.05		<0.05		<0.05		<0.05		<0.05							
Hg	0.0003		<0.0001		<0.0001		<0.0001		<0.0001		<0.0001							
SiO2	1.6		1.5		0.8		0.8		1		0.9							
F	0.2		0.1		<0.1		<0.1		<0.1		<0.1							

**APPENDIX C-7: Results of column leach tests involving Dugald River waste rock - Leachate composition for HW Calc-Silicate & Mafic Feldspar Porphyry (Column 6)**

Parameter	Collection Date and Duration of Leaching (days)																	
	19-Aug-08	16-Sep-08	15-Oct-08	11-Nov-08	9-Dec-08	12-Jan-09	3-Feb-09	5-Mar-09	31-Mar-09	28-Apr-09	26-May-09	23-Jun-09	22-Jul-09	18-Aug-09	15-Sep-09	13-Oct-09	10-Nov-09	1-Dec-09
	0	4	8	12	16	20	24	28	32	36	40	44	48	52	56	60	64	68
pH	8.97	9.08	9.19	9.22	8.76	8.09	9.22	6.57	8.51	7.47	8.94	8.73						
EC	100	106	76	73	69	90	70	65	67	61	53	43						
Alk	32	120	24	85	22	62	21	26	24	19	18	13						
Acy	<1	<1	<1	<1	<1	2	<1	<1	<1	<1	<1	2						
SO4	10	10	8	6	12	8	10	10	6	8	4	4						
Si	0.57		0.52		0.26		0.37		0.34		0.24							
Cl	5		8		1		4		<1		<1							
Ca	8		7		8		7		7		7							
Mg	<1		<1		<1		<1		<1		<1							
Na	9		7		7		5		4		3							
K	1		1		1		1		1		<1							
Al	0.09		0.05		0.05		0.04		0.07		0.04							
Sb	<0.001		<0.001		<0.001		<0.001		<0.001		<0.001							
As	<0.001		<0.001		<0.001		<0.001		<0.001		<0.001							
Be	<0.001		<0.001		<0.001		<0.001		<0.001		<0.001							
Ba	0.006		0.004		0.007		0.006		0.006		0.004							
Cd	<0.0001		<0.0001		<0.0001		<0.0001		<0.0001		<0.0001							
Cr	<0.001		<0.001		0.001		<0.001		<0.001		<0.001							
Co	<0.001		<0.001		<0.001		<0.001		<0.001		<0.001							
Cu	<0.001		<0.001		0.002		0.002		0.001		<0.001							
Pb	<0.001		<0.001		<0.001		<0.001		<0.001		<0.001							
Mn	0.012		0.01		0.023		0.01		0.011		0.008							
Mo	0.006		0.006		0.005		0.005		0.002		0.002							
Ni	<0.001		<0.001		<0.001		<0.001		<0.001		<0.001							
Se	<0.010		<0.010		<0.010		<0.01		<0.01		<0.01							
Ag	<0.001		<0.001		<0.001		<0.001		<0.001		<0.001							
Sr	0.019		0.015		0.018		0.015		0.01		0.008							
Th	<0.001		<0.001		<0.001		<0.001		<0.001		<0.001							
Sn	0.002		<0.001		<0.001		<0.001		<0.001		<0.001							
U	0.001		0.003		0.002		0.003		0.001		0.001							
Zn	<0.005		<0.005		0.006		<0.005		0.203		<0.005							
B	<0.05		<0.05		<0.05		<0.05		<0.05		<0.05							
Fe	<0.05		<0.05		<0.05		<0.05		<0.05		<0.05							
Hg	0.0003		<0.0001		<0.0001		<0.0001		<0.0001		<0.0001							
SiO2	1.2				0.5				0.8		0.7							
F	0.2		<0.1		<0.1		<0.1		<0.1		<0.1							

**APPENDIX C-8: Results of column leach tests involving Dugald River waste rock - Leachate composition for HW Mica Schist (Column 7)**

Parameter	Collection Date and Duration of Leaching (days)																	
	19-Aug-08	16-Sep-08	15-Oct-08	11-Nov-08	9-Dec-08	12-Jan-09	3-Feb-09	5-Mar-09	31-Mar-09	28-Apr-09	26-May-09	23-Jun-09	22-Jul-09	18-Aug-09	15-Sep-09	13-Oct-09	10-Nov-09	1-Dec-09
	0	4	8	12	16	20	24	28	32	36	40	44	48	52	56	60	64	68
pH	8.96	9.12	9.27	9.25	8.53	6.42	9.06	6.43	8.64	7.26	8.32	8.97						
EC	78	80	53	45	43	65	49	59	56	58	60	45						
Alk	24	47	36	35	23	44	17	27	23	16	19	15						
Acy	<1	<1	<1	<1	<1	2	<1	<1	<1	<1	<1	2						
SO4	9	10	5	1	3	3	4	5	3	4	3	3						
Si	0.56		0.49		0.15		0.33		0.41		0.19							
Cl	1		4		<1		2		<1		<1							
Ca	7		6		7		6		7		6							
Mg	<1		<1		<1		<1		<1		<1							
Na	6		4		3		3		2		2							
K	<1		<1		<1		<1		<1		<1							
Al	0.13		0.08		0.07		0.07		0.12		0.06							
Sb	<0.001		<0.001		<0.001		<0.001		<0.001		<0.001							
As	0.002		0.001		0.002		0.002		0.002		0.002							
Be	<0.001		<0.001		<0.001		<0.001		<0.001		<0.001							
Ba	0.002		0.001		0.001		0.001		0.001		0.001							
Cd	<0.0001		<0.0001		<0.0001		<0.0001		<0.0001		<0.0001							
Cr	<0.001		<0.001		<0.001		<0.001		<0.001		<0.001							
Co	<0.001		<0.001		<0.001		<0.001		<0.001		<0.001							
Cu	0.001		<0.001		0.002		0.001		<0.001		<0.001							
Pb	<0.001		<0.001		<0.001		<0.001		<0.001		<0.001							
Mn	0.011		0.009		0.017		0.009		0.009		0.009							
Mo	0.008		0.005		0.004		0.004		0.002		0.002							
Ni	<0.001		<0.001		<0.001		<0.001		<0.001		<0.001							
Se	<0.010		<0.010		<0.010		<0.01		<0.01		<0.01							
Ag	<0.001		<0.001		<0.001		<0.001		<0.001		<0.001							
Sr	0.011		0.007		0.007		0.006		0.004		0.004							
Th	<0.001		<0.001		<0.001		<0.001		<0.001		<0.001							
Sn	0.001		<0.001		<0.001		<0.001		<0.001		<0.001							
U	0.002		0.001		0.001		<0.001		<0.001		<0.001							
Zn	<0.005		<0.005		0.015		<0.005		0.013		<0.005							
B	<0.05		<0.05		<0.05		<0.05		<0.05		<0.05							
Fe	<0.05		<0.05		<0.05		<0.05		<0.05		<0.05							
Hg	0.0003		<0.0001		<0.0001		<0.0001		<0.0001		<0.0001							
SiO2	1.2		1		0.3		0.3		0.7		0.9							
F	0.1		<0.1		<0.1		<0.1		<0.1		<0.1							



## Appendix E: Column Cover Trials

# Column Cover Trials

## Tailings Storage Facility, Dugald River Mine

Prepared for MMG | September 2019



**WE MINE FOR  
PROGRESS**



*This page is intentionally blank*



# Column Cover Trials

Tailings Storage Facility

Dugald River Mine

Prepared for MMG | 12 September 2019

## Column Cover Trials | Tailings Storage Facility | Dugald River Mine

Project number:	17007
Document title:	Column Cover Trials   Tailings Storage Facility   Dugald River Mine
Revision:	V2-1
Date:	12 September 2019
Client:	MMG
Project manager:	T Rohde
Author:	N Jamson

SGM environmental Pty Limited  
T 0488 111 722  
E [admin@sgmenvironmental.com](mailto:admin@sgmenvironmental.com)  
W [www.sgmenvironmental.com](http://www.sgmenvironmental.com)



Positivity | Trust | Innovation | Safety

© Copyright 2017 SGM environmental Pty Limited. The concepts and information contained in this document are the property of SGM environmental Pty Limited. Use or copying of this document in whole or in part without the written permission of SGM environmental Pty Limited constitutes an infringement of copyright.

Limitation: This document has been prepared on behalf of, and for the exclusive use of SGM environmental Pty Limited clients, and is subject to, and issued in accordance with, the provisions of the contract between SGM environmental Pty Limited and the client. SGM environmental Pty Limited accepts no liability or responsibility whatsoever for, or in respect of, any use of, or reliance upon, this document by any third party.

### Document history and status

Revision	Date	Description	By	Review	Approved
V0-1	14 June 2019	Draft	N Jamson	T Rohde	T Rohde
V0-3	26 June 2019	Draft	N Jamson	T Rohde	T Rohde
V1-1	11 September 2019	Draft	N Jamson	C Rieck	T Rohde
V2-1	12 September 2019	Final	N Jamson	C Rieck	T Rohde



# Table of Contents

1.0	Introduction	9
1.1	Purpose	9
1.2	Location and tenements	9
1.3	Operational overview	9
1.4	Climate	11
1.5	Report structure	11
2.0	Cover System Selection and Objectives	13
2.1	GARD guide cover assessment	13
2.2	Environmental risk assessment	13
2.2.1	Results	13
2.3	Cover system objectives	19
3.0	Material Review	20
3.1	Tailings	20
3.1.1	Geochemistry	20
3.1.2	Unified soil classification system	20
3.1.3	Compaction	21
3.1.4	Permeability	21
3.2	Cover materials	22
3.2.1	Geochemistry	22
3.2.2	Physical characterisation	26
4.0	Cover Trial Development	33
4.1	Current closure plan cover	33
4.2	Preliminary cover model	35
4.2.1	Results	35
4.2.2	Preferred cover option	37
4.3	Final cover options to trial	37



## Table of Contents

5.0	Column Cover Trials	38
5.1	Method	38
5.1.1	Sensor calibrations	38
5.1.2	Construction	39
5.1.3	Filling	40
5.1.4	Installation of instruments	41
5.1.5	Wetting and drying	43
5.2	Results and discussion	44
5.2.1	Stored infiltration	44
5.2.2	EC	46
5.2.3	Water balance	48
6.0	Semi-calibrated SVFlux Modelling	49
6.1	Method	49
6.1.1	Model dimensions	49
6.1.2	Mesh geometry	50
6.1.3	Initial conditions	50
6.1.4	Analysis method	55
6.2	Results	56
6.2.1	Water balance	59
6.2.2	Future cover performance	61
6.2.3	Performance of the cover options compared to industry examples	62
7.0	Conclusions and Recommendations	65
7.1	Recommendations	66
	References	68



# Table of Contents

## Appendix

A	70
B	87
C	98
D	102
E	109
F	112
G	117
H	121
I	124

## Photograph

1	Cover column trial	39
2	Ponding of water on the trials	43
3	Matric suction sensor calibration	81

## Figure

1	Location of the Mine	10
2	Covers and climate types (from GARD Guide 2009)	13
3	Tailings PSD (MMG 2018)	21
4	Soil particle size distribution from hand textures using SoilVision	27
5	Particle size distributions of stockpiled topsoil (MMG 2018)	29
6	Particle size distributions of borrow subsoil	31
7	Cover cross section	34
8	Burial depth of sensors	42
9	Stored infiltration in the trials	45



# Table of Contents

<b>Figure</b>		
10	Electrical conductivity of the trials	47
11	Model dimensions	50
12	In-situ SWCCs	54
13	Model results compared to the trials	58
14	Location of mines with cover trials	63
15	Performance of Australian cover trials	64
16	Model cross section (a) cover option 1 (b) cover option 2 (c) cover option 3 (d) cover option 4	78
17	Generalised SWCC illustrating which part of the SWCC are measured by the calibration method	81
18	Cover option 1 matric suction sensor calibration curves	83
19	Cover option 2 matric suction sensor calibration curves	84
20	Cover option 3 matric suction sensor calibration curves	85
21	Cover option 4 matric suction sensor calibration curves	86
22	The trials matric suction results	88
23	The trials VWC results	89
24	Key elements of the SWCC	92
25	Model results compared to the trials	97
<b>Table</b>		
1	Environmental risk assessment	15
2	Tailings physical characterisation results	20
3	Classification according to permeability	21
4	Soil type, description, fertility and salinity	22
5	Stockpiled topsoil and borrow subsoil fertility assessment	24



## Table of Contents

Table		
6	Soil texture	27
7	Soil estimated saturated hydraulic conductivity	28
8	Summary of topsoil physical characterisation	28
9	Stockpiled topsoil PAWC	29
10	Summary of borrow subsoil physical characterization	31
11	Borrow subsoil PAWC	31
12	Summary of plasticity index results	32
13	Classification according to permeability	32
14	Summary of primary cover (cover option 1) water balance for average, wet and dry years	36
15	Summary of cover option 2 water balance for average, wet and dry years	36
16	Summary of cover option 3 water balance for average, wet and dry years	36
17	Summary of cover option 4 water balance for average, wet and dry years	36
18	Maximum water balance for each cover thickness	48
19	Annual rainfall and evaporation for model scenarios	56
20	Water balance summary for artificial rainfall	60
21	Water balance summary for 710 mm of artificial rainfall	60
22	Summary of cover option 1 water balance for average, wet and dry years	61
23	Summary of cover option 2 water balance for average, wet and dry years	61
24	Summary of cover option 3 cover water balance for average, wet and dry years	61
25	Summary of cover option 4 water balance for average, wet and dry years	61
26	Summary of climate for Australian mines with cover trials	62
27	Alternative covers options analysis	75

## Important note about your report

---

The sole purpose of this report and the associated services performed by SGM environmental Pty Limited (SGME) is to develop cover configurations and thicknesses (the covers) that are appropriate for the climate at Dugald River Mine and establish column trials (the trials) to test the performance of the covers in accordance with the scope of services set out in the contract between SGME and MMG. That scope of services, as described in this report, was developed with the Client.

In preparing this report, SGME has relied upon, and presumed accurate, any information (or confirmation of the absence thereof) provided by MMG and/or from other sources. Except as otherwise stated in the report, SGME has not attempted to verify the accuracy or completeness of any such information. If the information is subsequently determined to be false, inaccurate or incomplete then it is possible that our observations and conclusions as expressed in this report may change.

SGME derived the data in this report from information sourced from MMG, designated laboratories and/or information that has been made available in the public domain at the time or times outlined in this report. The passage of time, manifestation of latent conditions or impacts of future events may require further examination of the potential covers and subsequent data analysis, and re-evaluation of the data, findings, observations and conclusions expressed in this report.

SGME has prepared this report in accordance with the usual care and thoroughness of the consulting profession, for the sole purpose described above and by reference to applicable standards, guidelines, procedures and practices at the date of issue of this report. For the reasons outlined above, however, no other warranty or guarantee, whether expressed or implied, is made as to the data, observations and findings expressed in this report, to the extent permitted by law.

This report should be read in full and no excerpts are to be taken as representative of the findings. No responsibility is accepted by SGME for use of any part of this report in any other context.

Reporting of the physical and chemical characteristics of soil, rock and other cover materials are based on a desktop assessment of data that has been measured by MMG and other third parties.

This report has been prepared on behalf of, and for the exclusive use of, MMG, and is subject to, and issued in accordance with, the provisions of the contract between SGME and MMG.

SGME accepts no liability or responsibility whatsoever for, or in respect of, any use of, or reliance upon, this report by any third party.

# Executive summary

---

This study has shown through cover column trials (the trials) and a semi-calibrated model that the tailings storage facility (TSF) cover will likely require a 1 m thick infiltration storage layer (ISL) to reduce the potential for seepage into the potentially contaminating tailings. A reduction of rainfall infiltration will limit the potential for environmental harm through acid rock drainage (ARD) and limit water management requirements.

An environmental risk assessment was undertaken in conjunction with preliminary, uncalibrated modelling in SVFlux. The purpose of this was to determine the most suitable store and release cover options for the TSF (which would then progress to column trials). The preliminary model showed that cover option 2 was the preferred option. The availability of NAF waste rock for use in the TSF cover is unknown at this stage. Borrow subsoil was identified as a potential alternative material for use in the ISL and RPL. This material was therefore trialled in place of NAF waste rock in the trials.

The trials were commissioned in December 2018 and were subjected to varying amounts of artificial rainfall (510-910 millimetres (mm)) over a six-month period to develop a maximum water balance. The trials have not shown any signs of significant capillary rise. Following the trials, a semi-calibrated model was developed in SVFlux using maximum water balance from the trials. That is, soil water characteristic curves (SWCCs), saturated hydraulic conductivities and potential evaporation rates. The semi-calibrated model showed a good correlation to the observed results and it was accepted that the semi-calibrated model could be used to predict the long-term performance of the covers within a seepage error range of 4-7%.

Finally, the trials performance was simulated for a wet, average and dry year to predict the likely long-term performance of the four different covers had they been built on the TSF. The model was also run to simulate 710 mm of artificial rainfall applied to the trials (ie the artificial rainfall applied to cover option 3). The long-term prediction showed that a cover containing a 1 m thick ISL provides the best balance between rainfall infiltration storage and seepage. Seepage was predicted to be under 10% of annual rainfall in the long-term. The 710 mm of artificial rainfall model showed that the covers with a 0.5 m ISL are likely to experience high rates of seepage (>10% of annual rainfall) when subjected to short duration, high intensity rainfall (eg monsoonal conditions). This can be attributed to a lower infiltration storage capacity and as well as lower evaporation. A thicker ISL will also aid in the establishment of native vegetation and potentially further decrease seepage through transpiration. Cover option 1 and 2 are therefore the preferred cover options at this stage. Cover option 1 consists of:

- a 0.4 m CB layer of gap-graded NAF waste rock above the tailings at a density of 1.43 t/m<sup>3</sup>; and
- a 0.5 m RPL of borrow subsoil above the CB layer at a density of 2.31 t/m<sup>3</sup>; and
- a 1 m ISL of borrow subsoil above the RPL at a density of 1.64 t/m<sup>3</sup>; and
- a 0.2 m topsoil layer above the ISL at a density of 1.7 t/m<sup>3</sup>.

Cover option 2 consists of:

- a 0.3 m CB layer of gap-graded NAF waste rock above the tailings at a density of 1.38 t/m<sup>3</sup>;
- a 0.5 m RPL of borrow subsoil above the CB layer at a density of 2.27 t/m<sup>3</sup>;
- a 0.3 m CB layer of gap-graded NAF waste rock above the RPL at a density of 1.38 t/m<sup>3</sup>;
- a 1 m ISL of borrow subsoil above the CB layer at a density of 1.64 t/m<sup>3</sup>; and
- a 0.2 m topsoil layer above the ISL at a density of 1.7 t/m<sup>3</sup>.

The necessity of an RPL cannot be confirmed or rejected with confidence at this stage. Additional trials are required and are discussed in Section 7.1. Cover options 1-4 will also need to be re-trialled with NAF waste rock in place of borrow subsoil (in the RPL and ISL), as either of these materials may be used in the final TSF cover (depending on NAF waste rock availability) (see recommendations, Section 7.1).

A comparison to Australian examples of mine site covers suggests that the preferred covers would perform comparably to those in the literature and below the maximum desirable seepage rate. Option 3 and 4 would likely perform above the maximum desirable seepage rate during short duration, high intensity rainfall events. This review also suggests that a 1 m thick ISL is likely required and that the optimum cover thickness for the Mine is likely between 1.2-2.3 m (depending on whether an RPL and/or CBs are included).

Three recommendations are made from this study:

1. The *Conceptual Closure Plan* (MMG 2015) has the following material balance available:
  - 79,751 m<sup>3</sup> of soil (MMG 2015);
  - 25,445 m<sup>3</sup> of soil, rock and vegetation mulch; and
  - 3.5 Mt or 1,750,000 m<sup>3</sup> of NAF waste rock assuming a density of 2 t/m<sup>3</sup>.

A detailed study is required to identify the potential sources and total volumes of potential cover material.

2. As the ISL and RPL in the chosen cover may contain borrow subsoil or NAF waste rock (depending on NAF waste rock availability), it is recommended that cover options 1-4 are trialled with NAF waste rock substituted for borrow subsoil. These covers will then be subjected to an artificial rainfall program. These covers would therefore include:

- Cover option 5:
  - a 0.4 m CB layer of NAF waste rock;
  - a 0.5 m RPL of NAF waste rock above the CB;
  - a 1 m ISL of NAF waste rock above the RPL; and
  - a 0.2 m topsoil layer above the ISL.
- Cover option 6:
  - a 0.3 m CB layer of NAF waste rock;
  - a 0.5 m RPL of NAF waste rock above the CB;
  - a 0.3 m CB layer of NAF waste rock above the RPL;
  - a 1 m ISL of NAF waste rock above the CB layer; and
  - a 0.2 m topsoil layer above the ISL.
- Cover option 7:
  - a 0.3 m CB layer of NAF waste rock;
  - a 0.5 m RPL of NAF waste rock above the CB;
  - a 0.3 m CB layer of NAF waste rock above the RPL;
  - a 0.5 m ISL of NAF waste rock above the CB layer; and
  - a 0.2 m topsoil layer above the ISL.
- Cover option 8:
  - a 0.5 m ISL of NAF waste rock; and
  - a 0.2 m topsoil layer above the ISL.

3. The necessity of an RPL cannot be confirmed or rejected for the covers in this report. Additional trials (following the trials in recommendation 2) are therefore recommended to eliminate this uncertainty. This will involve decommissioning two column trials and constructing the following covers. These trials will then be subjected to an artificial rainfall program.

- Cover option 9:
  - a 0.5 m RPL of borrow subsoil;
  - a 1 m ISL of borrow subsoil above the RPL; and
  - a 0.2 m topsoil layer above the ISL.
- Cover option 10:
  - a 1 m ISL of borrow subsoil; and
  - a 0.2 m topsoil layer above the ISL.

These configurations could then be repeated for NAF waste rock in place of borrow subsoil if required.

4. Following the two sets of recommended trials, the covers of interest (based on the column trial results) should be moved to an uncovered position so that they are exposed to naturally occurring rainfall and evaporation. Vegetation should also be established on the trials. This will allow for a more thorough evaluation of the potential for capillary rise and the subsequent requirement for a CB. Periodic sampling of the trials could also be carried out. This will also allow the water balance to be further refined, including the prediction of long-term performance.
5. Large field trials should then be established and monitored prior to building the preferred cover on the TSF. The final decision on cover thickness should be based on (field) monitoring data for infiltration and seepage.

# 1.0 Introduction

---

## 1.1 Purpose

This report describes the development, implementation and findings from tailings cover column trials (the trials) conducted at Minerals and Metals Group (MMG) Dugald River Mine (the Mine). The trials were conducted to meet the requirements of the Mines Environmental Authority (EA) EPML 00731213 Schedule 1 – Land and Rehabilitation Conditions 115 to 117, as follows:

(115) Within six (6) months of the commencement of tailings disposal in the tailings storage facility, the holder of this environmental authority must commence trials to establish suitable capping systems for infrastructure on the licensed place including but not limited to the tailings storage facility and all waste rock dumps.

(116) By 1 October 2017 and once every two years thereafter the holder of the environmental authority must submit a report to the administering authority detailing the success and findings from the capping system trials.

(117) By 2 October 2019 the holder of the environmental authority must submit to the administering authority a report nominating the most appropriate capping system for the tailings storage facility based on the results from trials required in condition 118.

## 1.2 Location and tenements

The Mine is located approximately (~) 85 kilometres (km) north-east of Mt Isa and 65 km north-west of Cloncurry in north-western Queensland (Figure 1). The Mine is located within the Mount Isa Mineral Province which is characterised by mineral exploration, mining and pastoral activities. The Mine is located on Roseby Station pastoral leases (the station), owned by Macmillan Holdings. The station is used for cattle grazing on unimproved pastures.

The Mine tenure includes 40 mining leases (MLs), one mining lease application (MLA) and one mineral development licence (MDL) granted under the *Mineral Resources Act 1989* and subsequent *Mines and Energy Legislation Amendment Act 2011* (Figure 1).

The tailings storage facility (TSF) is located on ML90211 (Figure 1).

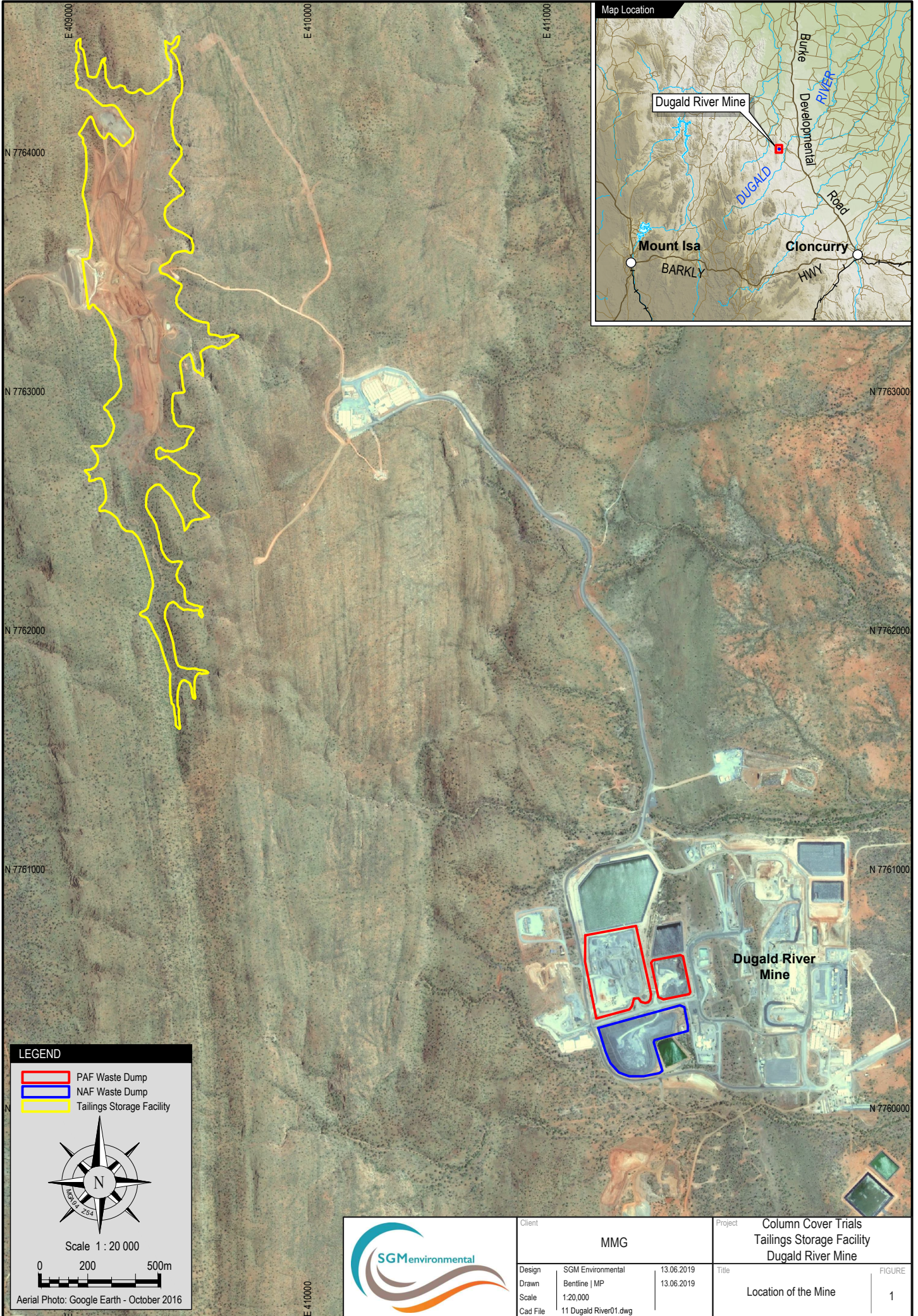
## 1.3 Operational overview

The Mine is an underground zinc (Zn) and lead (Pb) mine. Ore is mined underground using conventional long hole open stoping and down hole benching methods. The Mine is accessed by twin declines. Ore is trucked to the surface to the run of mine (ROM) pad and concentrated through a flotation separation plant. Metal concentrate is stockpiled in a concentrate storage shed prior to placement in sealed containers for transport offsite by truck. Process waste (tailings) is transferred to the TSF for final disposal, or combined with cement to paste fill underground voids. Non-ore grade waste rock is generally used as backfill underground. Where waste rock cannot be directly placed underground, it is classified based on sulfide concentration as 'non-acid forming' (NAF) or 'potential acid forming' (PAF) waste, segregated and transferred to the surface for temporary storage in separate waste rock dumps.

The site also includes accommodation infrastructure, sewage treatment plants, access roads and water containment infrastructure.

The Mine's TSF is a valley fill TSF with 2 discharge locations to the north and south. The target tailings solids content is 55% prior to discharge. The tailings beach grades down towards the centre of the TSF. Tailings supernatant pools occur in the centre of the TSF and are intermittently pumped back to the processing plant for reuse as process water.

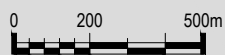




- LEGEND**
- PAF Waste Dump
  - NAF Waste Dump
  - Tailings Storage Facility



Scale 1 : 20 000



Aerial Photo: Google Earth - October 2016



Client	MMG		Project	Column Cover Trials Tailings Storage Facility Dugald River Mine	
Design	SGM Environmental	13.06.2019	Title	Location of the Mine	
Drawn	Bentline   MP	13.06.2019	FIGURE	1	
Scale	1:20,000				
Cad File	11 Dugald River01.dwg				



At rehabilitation, very little reprofiling of the TSF surface will be required other than the embankment which will be converted to a rock lined spillway. The spillway will move excess water (rainfall runoff and cover seepage) off the top surface of the rehabilitated landform, preventing ponding.

The tailings at the Mine have the potential to (refer to Section 3.1 for more detail):

- leach metal and are PAF ie they produce ARD;
- generate acidic conditions and oxidise soon after discharge into the TSF; and
- develop a hard pan on the surface soon after deposition resulting in tailings below ~0.5 metres below ground level (m bgl) remaining fresh and unoxidised indefinitely after deposition.

Therefore, the PAF tailings, like PAF waste rock, require careful rehabilitation to minimise the risk of environmental harm to the receiving environment from ARD.

The *Conceptual Closure Plan* (MMG 2015) nominates the following objectives:

- return most of the disturbed land to a condition like the pre-existing condition of low intensity grazing, native habitat or to an agreed beneficial use:
  - TSF changes from Land Suitability Class 4-5 to Class 5 ie unsuitable land with extreme limitations that preclude its use for further agricultural use but the land is suited to native habitat;
  - landscape functionality will be like identified reference sites; and
  - levels of metals, sulfate, pH and electrical conductivity (EC) in surface soils will be like that of surface soils on reference sites.
- make disturbed areas stable to ensure that the proposed subsequent land use is not compromised by surface instability or erosion; and
- ensure that constructed landforms are geochemically stable to the extent that they do not impact on surface water or groundwater quality.

## 1.4 Climate

The mean annual maximum temperature at Cloncurry is 31.2 degrees Celsius (°C), with November to January being the hottest months (>35°C). The mean annual minimum temperature is 18.5°C with June to August being the coolest months (<12°C).

The average annual rainfall for the region is 513 millimetres (mm). Regionally there is a distinct wet season (between November and April), with very little rain falling in the remaining months of the year. Historical rainfall data from the weather station at Cloncurry Airport (Station number: 029141) shows that January and February exhibit the highest mean monthly rainfall, with both months averaging above 100 mm (149.1mm and 116.9 mm respectively). These months also experience the rainiest days, with more than 7 rain days per month.

The driest months of the year are July and August with mean rainfall under 5 mm (4 mm and 4.15 mm respectively). These months average less than one day of rain.

The evaporation rate is primarily temperature-driven with the highest mean monthly evaporation (328.6 mm) occurring in December, and the lowest (159.0 mm) in June. Evaporation exceeds rainfall in all months by a factor of three.

## 1.5 Report structure

This report is presented as five topics to address EA condition 116:

- Section 2.0 presents a risk assessment and the cover objectives and desirable attributes which will guide cover design.



- Section 3.0 presents a review of the physical and chemical properties of topsoil, borrow subsoil, waste rock and tailings to determine the range of suitable cover materials available to rehabilitate the TSF.
- Section 4.0 presents a summary of the preliminary modelling and the covers which will progress to column trials.
- Section 5.0 presents the method and set-up and the results of the trials that have been established at the Mine to test four potential cover options.
- Section 6.0 presents the semi-calibrated model and provides a preliminary prediction of long-term performance.
- Section 7.0 presents conclusions and recommendations.

## 2.0 Cover System Selection and Objectives

### 2.1 GARD guide cover assessment

Applying the GARD Guide cover criteria to the Mines' climate suggests a **store and release cover** is the most suitable cover system for the Mine's TSF (Figure 2). No alternate cover systems have been assessed for application at the Mine. The subsequent materials review, cover modelling and column trials aim to determine the most effective store and release cover configuration to meet the cover system objectives.

A store and release cover is a cover system constructed to reduce net infiltration by storing moisture during higher precipitation periods and releasing moisture via evapotranspiration in dryer periods. The store and release cover may be combined with other engineered controls, for example a reduced permeability layer (RPL) and/or a capillary break layer/s (CB) to further reduce the potential for environmental harm from the TSF after closure.

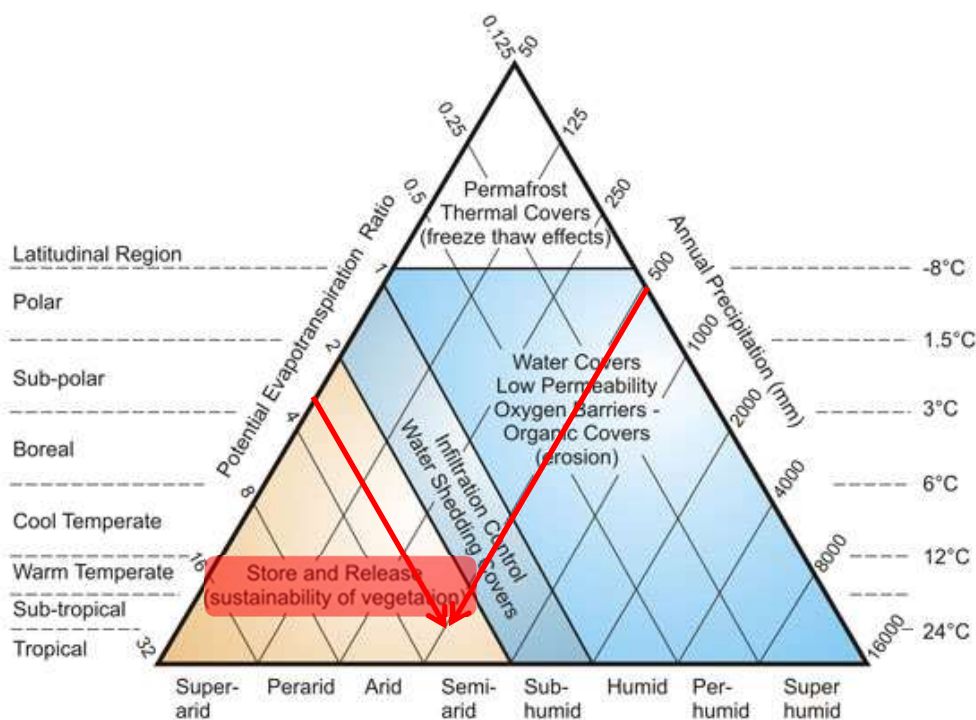


Figure 2 Covers and climate types (from GARD Guide 2009)

### 2.2 Environmental risk assessment

In order to define the basis of design for the store and release cover system and to guide the establishment of objectives for the cover system, an environmental risk assessment was conducted. The risk assessment assessed potential impacts on the receiving environment associated with the long-term storage of tailings in the TSF.

The environmental risk assessment was conducted using a risk assessment approach that is consistent with AS/NZS ISO 31000:2009, *Risk management - Principles and guidelines* (the risk standard), and the Mine risk evaluator developed by MMG (MMG document number I 6254157). The risk matrix which identifies likelihood descriptions and consequence ratings is presented in Appendix C.

#### 2.2.1 Results

Table I presents the environmental risk assessment grouped as per the key review areas.

These risks will be addressed through the cover which will incorporate characteristics described in the cover priorities and cover purpose and desirable attributes in Section 2.3. This information is all considered in the cover options analysis shown in Appendix D.

**Table I Environmental risk assessment**

Review topic	Hazard source	Risk name	Cause	Pathway	Receptor	Impact	Consequence	Likelihood	Risk level	Rationale
Geochemical	TSF	ARD	Sulfide oxidation with or without associated neutralisation reactions.	Infiltration, seepage, runoff	Surface water, groundwater, dependent ecosystems	Poor seepage water quality. Poor water quality in surface water and groundwater. Surface salts from evaporation of near surface infiltration.	5	E	Very high	Kinetic testing indicates tailings are acid forming and metal leaching. Tailings have little ANC.
		Exposure of PAF tailings	Catastrophic failure. Gully erosion. Differential settlement and cracking of TSF.	Infiltration, seepage, runoff, wind	Surface water, groundwater, dependent ecosystems	Increased solute load to environment.	5	E	Very high	As above.
		Poor quality seepage	Heavy rainfall events. Lack of water mixing. Poor water management. Constituents of concern in tailings.	Infiltration, seepage	Surface water, groundwater, dependent ecosystems	Poor seepage water quality. Release of heavy metals and salts from TSF by leaching. Poor water quality in surface water and groundwater.	5	E	Very high	As above.

Review topic	Hazard source	Risk name	Cause	Pathway	Receptor	Impact	Consequence	Likelihood	Risk level	Rationale
						Surface salts from evaporation of near surface infiltration.				
Erosivity		Wind erosion	Drying of TSF. Storm event (high winds).	Wind	Surface water, vegetation, grazing land, dependent ecosystems	Poor visual amenity. Spread of potentially contaminating tailings material on and off the ML. Smothering of vegetation.	3	D	Medium	Winds within the area can be variable and are influenced by the location of high-pressure cells and storm fronts that may move over the Mine. Windiest months occurring from October through to March.
		Water erosion	Run on. Access to land by cattle.	Runoff, infiltration, seepage	Surface water, groundwater, dependent ecosystems	Excessive downstream sedimentation. Increased seepage of poor quality water. Unsafe and unsustainable landform.	5	E	Very high	Hard-panning of surface layer as oxidation takes place.

Review topic	Hazard source	Risk name	Cause	Pathway	Receptor	Impact	Consequence	Likelihood	Risk level	Rationale
Surface water		Water logging	Head of water within TSF causing a groundwater mound, with seepage at the toe. Poor infiltration. Storm event.	Capillary rise	Vegetation	Death of vegetation. Capillary rise of salts. Instability of TSF embankment.	5	D	High	Monthly rainfall rarely exceeds evaporation.
Groundwater		Reduced water quality	Seeping of constituents from TSF into groundwater.	Infiltration, seepage	Groundwater, dependent ecosystems	Prevention of beneficial groundwater use.	3	B	Low	TSF is designed to contain all tailings and water. No seepage is anticipated and therefore there is no impact on the groundwater and pre-existing groundwater elevation.
Vegetation		Inability to establish and sustain native vegetation	Insufficient seed supply for rehabilitation. Insufficient and inappropriate	-	-	Poor visual amenity. Unstable landform with increased erosion rates.	3	E	High	Kinetic testing indicates tailings are acid forming and metal leaching. Unlikely to be

Review topic	Hazard source	Risk name	Cause	Pathway	Receptor	Impact	Consequence	Likelihood	Risk level	Rationale
			<p>growth medium with shortfalls in plant available water.</p> <p>Lack of evidence of ability to grow appropriate species in available substrate.</p> <p>Climatic uncertainty (extreme variability).</p>			Increased seepage of poor water quality.				favourable for plant growth.

## 2.3 Cover system objectives

Based on the outcomes of the environmental risk assessment the cover system objectives are as follows:

- limit rainfall infiltration into the tailings to prevent seepage, and mobilisation of oxidation products from the PAF tailings that may form ARD impacting on surface water and/or groundwater; and
- provide an environment favourable to the growth of vegetation and minimise the risk of erosion.

The TSF cover will have the following desirable attributes:

- The cover should be simple and easy to construct.
- The cover should mimic the surrounding undisturbed soil profile ie the cover should include an ISL capable of providing PAWC and nutrients to sustain vegetation growth.
- The geochemistry of the cover should closely replicate those of surrounding undisturbed soil. That is, the pH of the ISL should be near-neutral and non-saline and will likely have low fertility.
- The cover should limit the potential for seepage into the tailings. For semi-arid Australian environments, seepage should be less than 10% of cumulative rainfall or  $8.64 \times 10^{-4}$  m/day.
- If required, the cover should limit the potential for seepage by inclusion of an RPL.
- If required, the cover should limit the potential for capillary rise by inclusion of a CB if required.

These objectives and desirable attributes are aligned to the Mine's *Conceptual Closure Plan* (MMG 2015) objectives of:

- return the majority of disturbed land to a condition similar to the pre-existing condition of low intensity grazing, native habitat or to an agreed beneficial use;
- on rehabilitation of the Project, make disturbed areas stable to ensure that the proposed subsequent land use is not compromised by surface instability and erosion; and
- ensure that constructed landforms are geochemically stable to the extent that they do not impact on surface water or groundwater quality.



## 3.0 Material Review

---

The purpose of this chapter is to review soil, waste rock, and tailings:

- geochemistry;
- physical attributes; and
- research undertaken to date towards potential cover designs.

Any potential constraints and opportunities that may give rise to potential risks, and would influence the cover design, are also discussed.

### 3.1 Tailings

#### 3.1.1 Geochemistry

EGi (2009) completed a geochemical analysis of a sample of tailings to determine total sulfur (S), net acid generation (NAG) and potential sulfate loads in a kinetic column test. The geochemical analysis found that the tailings sample had a total S of 7.9 % and was strongly acid generating with a NAG capacity of 86 kilograms of sulfuric acid per tonne of tailings (kg H<sub>2</sub>SO<sub>4</sub>/t). Under column leach testing, the tailings acidified to around pH 3.5 within the first few months of leaching. Over the course of the 52-week column test, the concentration of sulfate in leachate ranged from 1,640-5,720 milligrams per litre (mg/L) and averaged 3,080 mg/L.

Static geochemical testing of three tailings samples were undertaken as part of the MMG (2018) sampling program (Appendix A). The tailings had a total S content of 7.25-7.94% with a NAG capacity of 132-149 kg H<sub>2</sub>SO<sub>4</sub>/t. Net acid production potential (NAPP) values ranged from 219-232 kg H<sub>2</sub>SO<sub>4</sub>/t. These results are consistent with the EGi (2009) findings. Water-soluble metals are those that are easily leachable in rainfall and surface runoff. Water-soluble levels of aluminium (Al), Pb, manganese (Mn) and Zn were elevated.

Therefore, the tailings at the Mine will be PAF and are expected to produce acidic seepage with high concentrations of metals and sulfates.

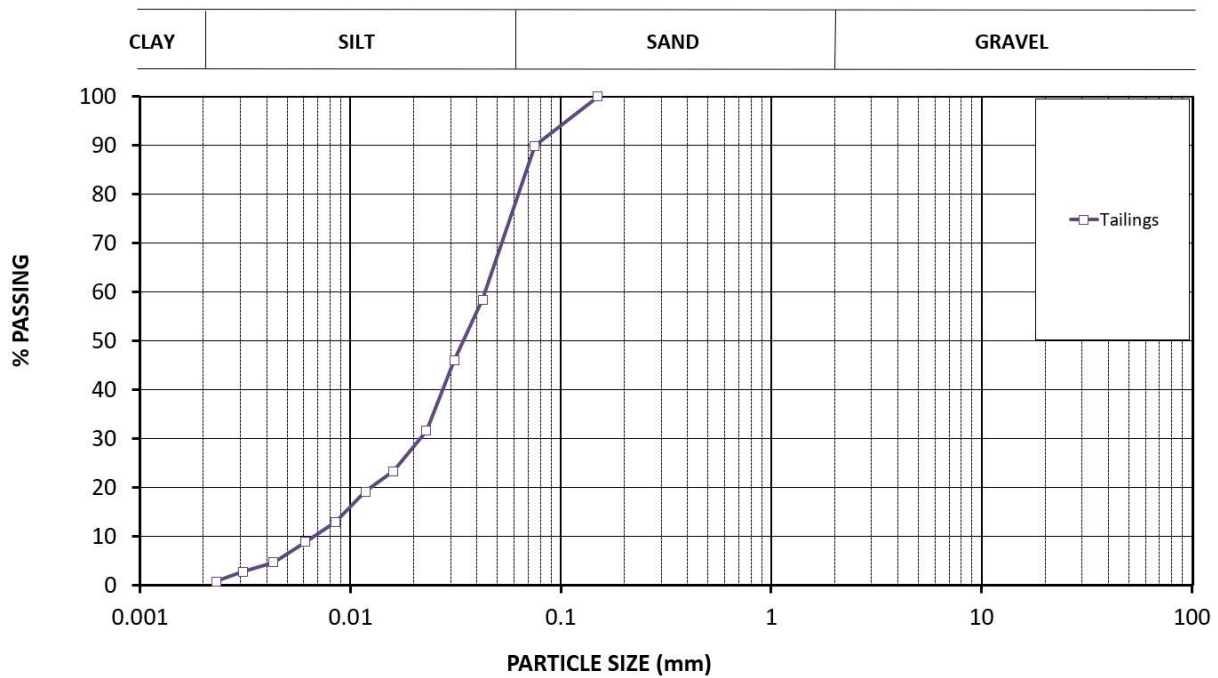
#### 3.1.2 Unified soil classification system

ATC Williams (2008 and 2015) and MMG (2018) collected a sample of tailings from the Mine which was submitted to a laboratory for particle size distribution analysis. The MMG (2018) sample consists largely of silt with smaller amounts of fine sand and clay (Figure 3).

Other available physical characterisation results for tailings are reported in (MMG 2018, ATC 2008 and ATC Williams 2015) Table 2. The MMG (2018) results are presented in Appendix B.

**Table 2 Tailings physical characterisation results**

Test	ATC (2008)	ATC Williams (2015)	MMG (2018)
Specific gravity	2.96	2.97	3.04
<b>Atterberg limits</b>			
Liquid limit	21	19	29
Plasticity Index	6	0	8
Unified soil classification	Low plasticity clay	Low plasticity silt	Low plasticity clay



**Figure 3 Tailings PSD (MMG 2018)**

### 3.1.3 Compaction

MMG (2018) collected a bulk tailings sample for standard compaction tests. This was used to determine the standard maximum dry density (SMDD) and standard optimum moisture content (SOMC) which came in at 1.68 tonnes per cubic metre ( $t/m^3$ ) and 20% respectively.

### 3.1.4 Permeability

Saturated hydraulic conductivity was measured by ATC Williams (2015) as part of a rowe cell consolidation test. The saturated hydraulic conductivity of the tailings ranges between  $3 \times 10^{-8}$  meters per second (m/s) to  $2 \times 10^{-7}$  m/s. Assuming that each metre of cover applies about 35 kilopascals (kPa) of pressure (Williams & King 2016) then the corresponding void ratio ( $e$ ) is equal to 0.85 or  $6 \times 10^{-8}$  m/s.

Saturated hydraulic conductivity was measured using the constant head method by MMG (2018). The tailings sample is classified as having an extremely low permeability (at 95% SMDD) (Greeves et al. 1995) (Table 3) ( $4.1 \times 10^{-8}$  m/s).

**Table 3 Classification according to permeability**

Degree of permeability	Range of coefficient of permeability $k$ (m/s)
Very high	$>3.3 \times 10^{-5}$
High	$3.3 \times 10^{-5}$ to $1.7 \times 10^{-5}$
Moderate	$1.7 \times 10^{-5}$ to $5.6 \times 10^{-6}$
Low	$5.6 \times 10^{-6}$ to $2.8 \times 10^{-6}$
Very low	$2.8 \times 10^{-6}$ to $1.4 \times 10^{-7}$
Extremely low	$< 1.4 \times 10^{-7}$

## 3.2 Cover materials

The available materials at the Mine to construct a store and release cover are topsoil, borrow subsoil and NAF waste rock.

### 3.2.1 Geochemistry

#### 3.2.1.1 Soil

The characteristics of soil in the vicinity of the operation have been determined by reviewing soil studies conducted during the Mine's environmental approvals process (AARC 2010) and analysis of stockpiled topsoil conducted in 2018 (MMG) during the trials.

#### 3.2.1.2 Pre-disturbance soil

##### a Fertility

Soil fertility was assessed by AARC (2010) as part of the land suitability assessment for the environmental approval for the Mine (the land suitability assessment). The land suitability assessment described six types of soil broadly categorised as non-texture contrast soil. That is, the soil horizons do not have large textural changes (Table 4). The low fertility classification is derived from a laboratory assessment of the soil types for nitrate, total and available phosphorous (P), available potassium (K), organic carbon, chloride and exchangeable cations (AARC 2010). All soil types display circum-neutral pH (AARC 2010) and do not require pH correction before vegetation can be established.

**Table 4 Soil type, description, fertility and salinity**

Soil type	Australian Soil Classification	Description	Fertility	Salinity
Red plain	Rudosol	Sandy loam to sandy clay loam at least 75 cm deep usually overlying rock at shallow depth	Generally low	Non-saline
Knapdale	Tenosol	Skeletal sandy clay loam overlying rock at shallow depth	Generally low	Non-saline
Dale	Tenosol	Sandy loam at least 75 cm deep usually overlying rock at shallow depth	Generally low	Non-saline
Miners	Rudosol	Sandy clay loam overlying rock at shallow depth	Generally low	Non-saline
Prospectors	Tenosol	Clay loam overlying rock at shallow depth	Generally low	Non-saline
Pocket	Tenosol	Sand and/or clay loam overlying rock at shallow depth	Generally low	Non-saline

Based on the assessment of soil fertility (AARC 2010), it can be assumed that stockpiled soil that may be used in the cover will be non-saline and will have generally low to moderately low fertility. It is not expected to limit vegetation establishment.

##### b Metal concentrations

As part of the AARC (2010) land suitability assessment, metal concentrations were measured to determine baseline soil conditions. The Mine lies in a mineralised zone and metals such as Pb, silver (Ag), Cu, Zn, iron (Fe), boron (B) and Mn may be elevated in the soil. Metal concentrations were assessed for each soil type against the *Draft Guidelines for the Assessment and Management of Contaminated Land in Queensland* (DERM 1998). The AARC (2010) analysis found that concentrations of Cu, Fe, Mn, Zn and B were all below environmental and health investigation limits described in Appendix 9.1 of DERM (1998). The concentration of Pb exceeded both the environmental and health investigation limits described in Appendix 9.1 of DERM (1998) in the Miners soil unit. Therefore, an elevated Pb concentration in the cover may not be a result of contamination.

c Erosivity

All soil types were assessed for exchangeable sodium percentage (ESP) and exchangeable calcium (Ca). AARC (2010) found that all soil types had ESP values less than 6% and are Ca dominated. Therefore, the soils are not dispersive.

### 3.2.1.3 Stockpiled topsoil

Three samples of stockpiled topsoil were collected by the Mine as part of this study (MMG 2018). The full chemistry results are shown in Appendix A.

a Fertility

Stockpiled topsoil fertility results are presented in Table 5:

- Exchangeable magnesium (Mg) and K are both considered adequate while Ca is very high. ESP is very low indicating that the topsoil is not sodic. Cation exchange capacity (CEC) is either slightly below or just above sufficiency levels indicating a limited capacity to store nutrients.
- Topsoil is moderately alkaline (pH 8.2-8.3) which is consistent with the Pocket soil type identified in Section 3.2.1.2a. The elevated exchangeable Ca indicates that the source of the alkalinity is from calcium carbonates. This pH range is not expected to restrict plant growth.
- Topsoil EC is moderate with most of this salinity coming from soluble carbonates and sulfate salts (not chloride). It is important to note that sulfate salinity is generally better tolerated than chloride salinity. EC is unlikely to restrict plant growth.
- Total nitrogen (N) levels are very low while soluble nitrite and nitrate are below sufficiency levels in two out of the three samples. Nitrogen deficiency may be a restriction to plant growth.
- P (Colwell) is above sufficiency levels for all samples indicating that P is unlikely to be a restriction to plant growth.

The stockpiled topsoil has similar chemical properties to pre-disturbance soils and is therefore expected to match surface soil pH, EC, sulfate and soluble metals of reference sites. It is expected that the stockpiled topsoil will exhibit low to moderately low soil fertility but not to the point that it is expected that vegetation will not establish in the topsoil.

**Table 5 Stockpiled topsoil and borrow subsoil fertility assessment**

Constituent	Unit	Sufficiency	Sample					
			Topsoil 1	Topsoil 2	Topsoil 3	Borrow subsoil 1	Borrow subsoil 2	Borrow subsoil 3
pH	pH unit	6.0-7.5	<b>8.2</b>	<b>8.2</b>	<b>8.3</b>	<b>8.4</b>	<b>8.5</b>	<b>8.6</b>
EC	deci-Siemens per meter (dS/m)	<1.9	1.2	1.5	1.1	<b>2.4</b>	1	1.1
Soluble chloride	Milligrams per kilogram (mg/kg)	<800	<10	<10	<10	20	<10	<10
Soluble sulfate	mg/kg	-	20	20	20	140	10	20
CEC	milliequivalent/100 grams (meq/100 g)	12-25	<b>8.7</b>	<b>8.1</b>	<b>9.2</b>	<b>11.1</b>	<b>10.5</b>	12.6
Exchangeable Ca	%	60-75	<b>85.1</b>	<b>84.0</b>	<b>84.8</b>	<b>80.2</b>	<b>81.0</b>	<b>82.5</b>
Exchangeable Mg	%	10-20	11.5	11.1	10.9	16.2	13.3	14.3
Exchangeable K	%	3-8	3.4	3.7	3.3	3.6	5.7	3.2
Exchangeable aluminium (Al)	%	<1	<1	<1	<1	<1	<1	<1
ESP	%	<6	<0.2	<0.2	<0.2	<0.2	<0.2	<0.2
Nitrite and nitrate	mg/kg	>15	<b>7.8</b>	22.3	<b>1.8</b>	79.5	<b>11.1</b>	<b>14.7</b>
Total N	mg/kg	>1,500	<b>470</b>	<b>380</b>	<b>350</b>	<b>750</b>	<b>570</b>	<b>880</b>
Bicarbonate extractable P (Colwell)	mg/kg	>10	14	17	15	<b>&lt;5</b>	<b>8</b>	<b>6</b>

Notes: 1. Bold = did not meet or exceed sufficiency target

b Erosivity

The stockpiled topsoil has a very low ESP indicating that it is not sodic. Structural stability of soil is heavily influenced by a combination of EC of the soil solution and ESP. If a soil is sodic, it is vulnerable to dispersion. Dispersed soils have reduced infiltration and hydraulic conductivity leading to an increased potential for erosion and build-up of salts in the root zone. Dispersion declines as the EC of the soil solution increases. The Electrochemical Stability Index (ESI) expresses this relationship (EQN1):

$$ESI = EC_{1:5}/ESP \quad [EQN1]$$

Australian soils with an ESI <0.05 have the potential to disperse. The median ESI of the stockpiled topsoil was 500, indicating a high structural stability. The topsoil has a low to moderate fine sand and silt content. These particles are most susceptible to liquefaction.

The Emerson aggregate test showed that all samples fall into either Class 4 or Class 8. Class 4 indicates the topsoil will readily slake but with a low risk of dispersion. Class 8 indicates that the topsoil will not readily slake with a negligible risk of dispersion. Therefore, the topsoil is non-dispersive and has low potential to erode.

### 3.2.1.4 Borrow subsoil

a Fertility

Three samples of borrow subsoil were collected by the Mine as part of this study (MMG 2018). Results are presented in Table 5 and Appendix A:

- Exchangeable Mg and K are both considered adequate while Ca is very high. ESP is very low indicating that the borrow subsoil is not sodic. CEC is either slightly below or just above sufficiency levels indicating a limited capacity to store nutrients.
- The borrow subsoil is moderately to strongly alkaline (pH 8.4-8.6) which is consistent with the topsoil described in Section 3.2.1.3a. The elevated exchangeable Ca indicates that the source of alkalinity is from calcium carbonates. This pH range is not expected to restrict plant growth.
- EC is moderate to high with most of this salinity coming from soluble carbonates and sulfate salts (and not chloride). It is important to note that sulfate salinity is generally better tolerated than chloride salinity. EC is unlikely to restrict plant growth.
- Total N levels are very low while soluble nitrite and nitrate are below sufficiency levels in two out of the three samples. Nitrogen deficiency may be a restriction to plant growth.
- P (Colwell) is below sufficiency levels for all samples indicating that P may be a restriction to plant growth.

It is expected that the borrow subsoil will exhibit low soil nutrition but not to the point that it is expected that vegetation will not establish in the borrow subsoil.

b Erosivity

The borrow subsoil samples have a very low ESP indicating that they are not sodic. The borrow subsoil also had a median ESI of 510, indicating a high structural stability. The borrow subsoil samples have a low to moderate fine sand and silt content. The Emerson aggregate test showed that all samples fall into Class 4. Class 4 indicates the borrow subsoil; will readily slake but with a low risk of dispersion. Therefore, the borrow subsoil is non-dispersive and has a low potential to erode.

### 3.2.1.5 Waste rock

Waste rock was first geochemically analysed by AGC Woodward-Clyde (1991) followed by AARC (2008) (the early geochemical analysis) with further analysis completed by EGi (2010). The early geochemical analysis found that:

- the initial pH of most samples was circum-neutral, suggesting that drainage from freshly mined waste rock will likely be neutral to alkaline;
- most samples were enriched to some extent with sulfur (S), but most samples also had high to very high acid neutralising capacity (ANC) and were classified as NAF;
- S contents were distributed as follows:
  - 30% low (<0.01 to 0.3 %S);
  - 20% low to moderate (0.3 to 1.0 %S); and
  - 50% high to very high (> 1%S).
- ANCs were distributed as follows:
  - 14% low (<10 kilograms of sulfuric acid per tonne of waste rock (kg H<sub>2</sub>SO<sub>4</sub>/t));
  - 28% low-moderate (10 to 50 kg H<sub>2</sub>SO<sub>4</sub>/t); and
  - 58% high to very high (>50 kg H<sub>2</sub>SO<sub>4</sub>/t).

The early geochemical analysis also found that ~70-75% of waste rock would be PAF with PAF waste rock coming from the lode, hanging wall and foot wall.

#### *PAF waste rock*

Geochemistry was further assessed by EGi (2010) who also reported that the majority of PAF waste rock will be associated with the lode. Waste rock from within the lode will have:

- a high to very high capacity for acid generation (high sulfur content (9.47 %S));
- a low to moderate ANC (36 kg H<sub>2</sub>SO<sub>4</sub>/t); and
- a high net acid producing potential (NAPP) (254 kg H<sub>2</sub>SO<sub>4</sub>/t) if stockpiled in WRDs.

It is also likely that some waste rock from the adjoining hanging wall and foot wall will also be PAF. The acidification of PAF waste rock is likely to lead to leaching of Fe, Zn, Mn and Al, all of which are enriched (EGi 2010). However, other environmentally important metals such as mercury (Hg), arsenic (As), chromium (Cr), Pb, antimony (Sb), tin (Sn) and selenium (Se) are expected to remain below the analytical detection limit (EGi 2010).

#### *NAF waste rock*

NAF waste rock at the Mine is most likely associated with calc-silicate, mafic feldspar porphyry, white mica schist lithologies and footwall limestone lithology. Further, the calc-silicate and footwall limestone are likely to have a high to very high ANC ranging from 80-222 kg/t H<sub>2</sub>SO<sub>4</sub> (EGi 2010). NAF waste rock leachate is:

- expected to be neutral to moderately alkaline (pH 7.6-8.4);
- have moderate alkalinity (21-54 milligrams per litre (mg/L));
- low to moderate sulfate (4-46 mg/L); and
- low Ca concentrations (7-17 mg/L).

NAF waste rock is not expected to release metals; however, Zn, Hg, Mn and Ca concentrations may approach the analytical detection limit (0.0001 mg/L) (EGi 2010).

Therefore, NAF waste rock is considered an asset at the Mine and is suited for use for rehabilitation and civil construction activities. Excess NAF waste rock should only be returned underground as stope fill if not used in rehabilitation or construction projects.

## 3.2.2 Physical characterisation



The physical characteristics of soil, borrow subsoil, and tailings will determine the potential performance of the cover. Ore is not included in this section since it is PAF and is mined for sale and therefore not available for rehabilitation earthworks. Residual ore remaining on the PAF WRD will be used as stope fill.

The following sections describe the physical characteristics of potential cover materials and tailings that will be used in the preliminary and semi-calibrated SVFlux models (SoilVision 2018) to determine how a range of potential covers may behave after construction on the TSF.

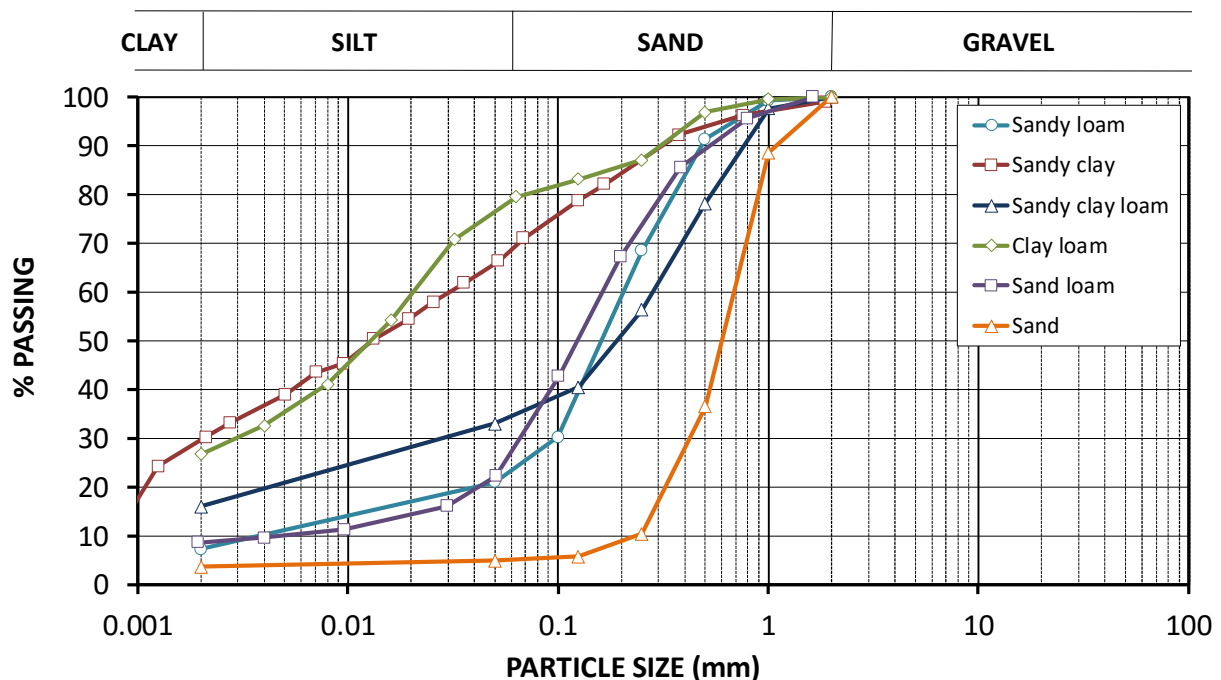
### 3.2.2.1 Pre-disturbance soil

#### a Particle size distribution

Soil texture was assessed in the field by AARC (2010) using hand texturing (Table 6). The hand texture classification can be converted to a particle size distribution using reference soils in the SoilVision (2009) program (Figure 4).

**Table 6 Soil texture**

Soil type	Hand texture result
Red plain	Sandy loam to sandy clay
Knapdale	Sandy clay loam
Dale	Sandy loam
Miners	Sandy clay loam
Prospectors	Clay loam
Pocket	Sand and/or clay loam



**Figure 4 Soil particle size distribution from hand textures using SoilVision**

Figure 4 indicates that the soil textures described by AARC (2010) are likely bound by sand and clay loam at the lower and upper limits respectively.

b Permeability

Soil permeability can be estimated from hand texture, structure, ESP and EC using the scheme described in Charman & Murphy (2010) (Table 7).

**Table 7 Soil estimated saturated hydraulic conductivity**

Soil type	Hand texture result	Structure	ESP	Median EC	Low saturated hydraulic conductivity	High saturated hydraulic conductivity
		Units	%	dS/m	metres per second (m/s)	m/s
Red plain	Sandy loam to sandy clay	Single grain/weak	<5%	<0.7	$1.67 \times 10^{-5}$	$1.94 \times 10^{-4}$
Knapdale	Sandy clay loam	Single grain/weak	<5%	<0.7	$1.67 \times 10^{-5}$	$1.94 \times 10^{-4}$
Dale	Sandy loam	Single grain/weak	<5%	<0.7	$1.67 \times 10^{-5}$	$1.94 \times 10^{-4}$
Miners	Sandy clay loam	Single grain/weak	<5%	~0.8	$1.39 \times 10^{-6}$	$5.56 \times 10^{-6}$
Prospectors	Clay loam	Single grain/weak	<5%	<0.7	$2.78 \times 10^{-8}$	$6.94 \times 10^{-7}$
Pocket	Sand and/or clay loam	Single grain/weak	<5%	<0.7	$3.33 \times 10^{-5}$	$8.33 \times 10^{-5}$

The average saturated hydraulic conductivity of soil at the mine is  $6.88 \times 10^{-5}$  m/s.

### 3.2.2.2 Stockpiled topsoil

Physical characterisation data was collected on the stockpiled topsoil as part of the MMG (2018) sampling program (Appendix B).

a Unified soil classification system

Two basic parameters can be determined from the particle size distribution curves (Figure 5). These are the effective size,  $D_{10}$ , which is the particle size in mm through which 10% of the particle size passes, the uniformity coefficient,  $C_u$ ; and the coefficient of curvature,  $C_z$ .  $C_u$  and  $C_z$  are defined by the following relationships (Das 2000 & Das 2002).

$$[EQN2]$$

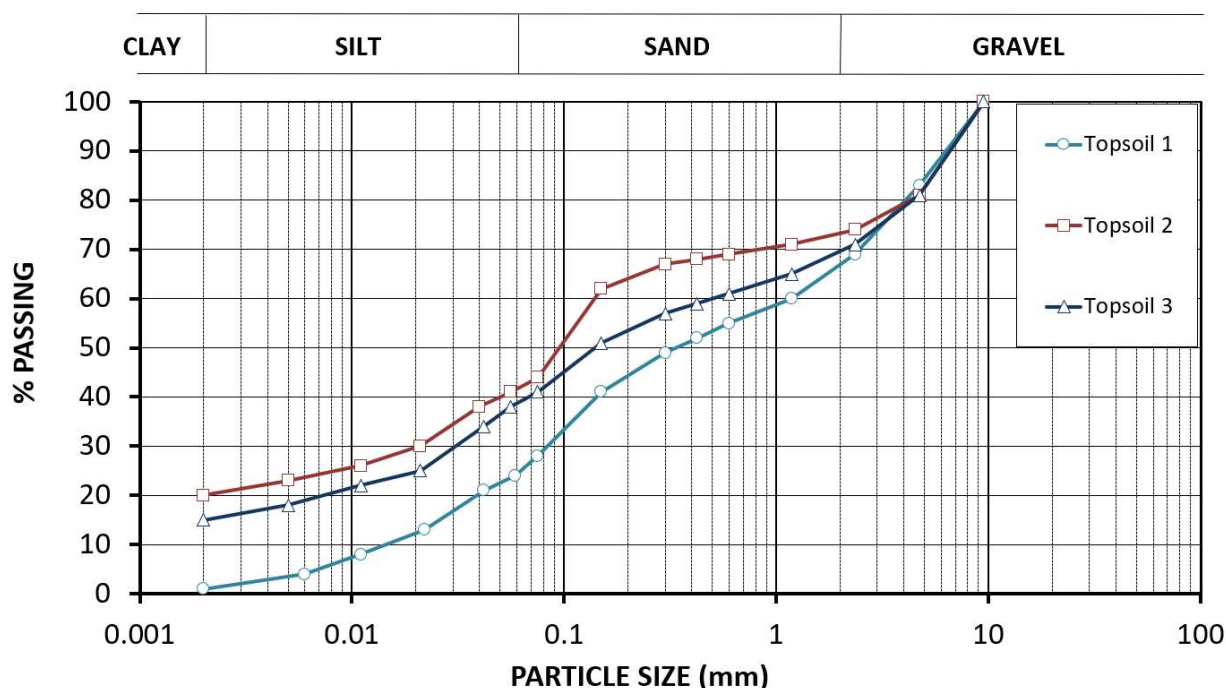
$$[EQN3]$$

The parameters shown in Table 8 may be used to classify the stockpiled topsoil in terms of its grading. The higher the value of the  $C_u$ , the larger the range of particle sizes in the material. A well-graded material is regarded as one that has a  $C_u$  greater than about 4 if it is primarily a gravel matrix, and 6 if it is sand; and a  $C_z$  between 1 and 3, for both sand and gravel (Das 2000 & Das 2002).

**Table 8 Summary of topsoil physical characterisation**

Sample identification	D <sub>10</sub> (mm)	D <sub>30</sub> (mm)	D <sub>60</sub> (mm)	C <sub>u</sub>	C <sub>z</sub>
Topsoil 1	0.015	0.08	1.2	80	0.36
Topsoil 2	0.001	0.02	0.15	150	2.7
Topsoil 3	0.001	0.03	0.5	500	1.8

Topsoil in its current state is well-graded except for Topsoil 1 which is poorly graded due to a low clay content. Well-graded materials have a lower propensity for segregation of coarse and fine particles. This can potentially lead to macropore flow and unacceptable rates of seepage from the cover.



**Figure 5 Particle size distributions of stockpiled topsoil (MMG 2018)**

**b Plant available water capacity**

The potential plant available water capacity (PAWC) has been derived from the difference between the volumetric water content (VWC) of the water-entry value and the air-entry value. These values were obtained from the SWCCs measured in the trials (Section 6.1.3.2a).

**Table 9 Stockpiled topsoil PAWC**

Sample identification	PAWC (1 metre of stockpiled topsoil)	PAWC classification
Topsoil 1	25 mm	Very low (<50mm)
Topsoil 2	28 mm	Very low (<50mm)
Topsoil 3	27 mm	Very low (<50 mm)

In general, the stockpiled topsoil has a low PAWC. The ISL will therefore need to be sufficiently thick to account for this.

### 3.2.2.3 Borrow subsoil

Physical characterisation data was collected on borrow subsoil as part of the MMG (2018) sampling program (Appendix B).

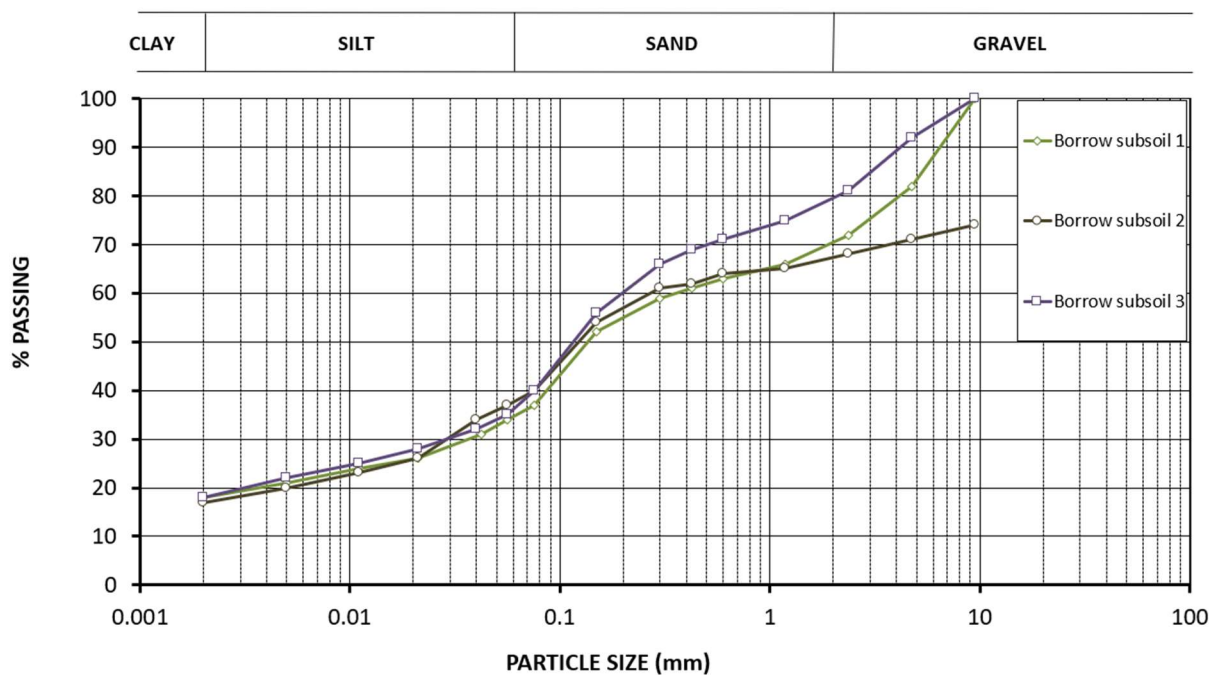
#### a Unified soil classification system

The PSD for the borrow subsoil is shown in Figure 6.  $C_u$  and  $C_z$  values for the borrow subsoil samples are shown in Table 10.

**Table 10 Summary of borrow subsoil physical characterisation**

Sample identification	D <sub>10</sub> (mm)	D <sub>30</sub> (mm)	D <sub>60</sub> (mm)	C <sub>u</sub>	C <sub>z</sub>
Borrow subsoil 1	0.001	0.042	0.35	350	5
Borrow subsoil 2	0.001	0.027	0.28	280	2.6
Borrow subsoil 3	0.001	0.027	0.2	200	3.6

Two borrow subsoil samples are slightly poorly graded (Borrow subsoil 1 and Borrow subsoil 3) and one is well-graded (Borrow subsoil 2). The borrow subsoil is still expected to compact to a dense state. Optimum compaction; however, will be achieved when the particle size distribution is closest to ideal (represented by a straight line through the target particle sizes). The poor grading of the material may also lead to some macropore flow and potentially higher rates of seepage.



**Figure 6 Particle size distributions of borrow subsoil**

**b Plant available water capacity**

The potential PAWC has been derived from the difference between the VWC of the water-entry value and the air-entry value. These values were obtained from the SWCCs measured in the trials (Section 6.1.3.2a).

**Table 11 Borrow subsoil PAWC**

Sample identification	PAWC (1 metre of borrow subsoil)	PAWC classification
Borrow subsoil 1	25 mm	Very low (<50mm)
Borrow subsoil 2	26 mm	Very low (<50mm)
Borrow subsoil 3	31 mm	Very low (<50 mm)

In general, the potential cover ISLs have a low PAWC. The ISL will therefore need to be sufficiently thick to account for this.

c Shrink/swell properties

The potential for the borrow subsoil to shrink and/or swell is determined from the Atterberg limit test and the particle size distribution. The most useful of the Atterberg limits is the plastic limit which is summarised in Table 12. Table 12 shows that the sample is classified as slightly plastic. Materials with a high plasticity index tend to be clay, those with a medium plasticity index tend to be silt, and those with a plasticity index of 0-3 (non-plastic) tend to have little or no silt or clay (Fredlund & Rahardjo 1993).

**Table 12 Summary of plasticity index results**

Sample identification	(0-3)	(3-15)	(15-30)	>30
	non-plastic	slightly plastic	medium plastic	highly plastic
Borrow subsoil	-	9	-	-

The shrink/swell potential of the spoil can be assessed using the plasticity index. The critical value for the plasticity index varies between guidelines but generally a plasticity index of >25% indicates a high potential for shrink/swell behaviour. The borrow subsoil is below the critical value indicating that there is low potential for shrink/swell behaviour. Secondary flow paths are unlikely to form as a result of the material drying out and cracking.

d Compaction

Standard compaction tests were completed on the borrow subsoil to determine the standard maximum dry density (SMDD) and standard optimum moisture content (SOMC) which came in at 2.03 t/m<sup>3</sup> and 9.5% respectively.

e Permeability

Saturated hydraulic conductivity was measured using the constant head method. The borrow subsoil is classified as having an extremely low permeability (at 95% SMDD) (based on Greeves et al. 1995) ( $7.4 \times 10^{-10}$  m/s) (Table 13). Borrow subsoil would therefore likely be suitable for use in an RPL.

**Table 13 Classification according to permeability**

Degree of permeability	Range of coefficient of permeability $k$ (m/s)
Very high	$>3.3 \times 10^{-5}$
High	$3.3 \times 10^{-5}$ to $1.7 \times 10^{-5}$
Moderate	$1.7 \times 10^{-5}$ to $5.6 \times 10^{-6}$
Low	$5.6 \times 10^{-6}$ to $2.8 \times 10^{-6}$
Very low	$2.8 \times 10^{-6}$ to $1.4 \times 10^{-7}$
Extremely low	$< 1.4 \times 10^{-7}$

## 4.0 Cover Trial Development

---

### 4.1 Current closure plan cover

The current conceptual Mine Closure Plan describes the primary (referred to as cover option 1), unproven, 1.9 m cover design for the rehabilitation of the TSF. This cover system's layers are presented and described in Figure 7.



Cross section	Thickness (m)	Material properties	Material source	Placement and compaction
	0.2	Soil (soil and/or soil, rock and vegetation mulch)	Soil stockpiles 105,196 m <sup>3</sup>	End dumping No compaction 50% of TSF area only
	1.0	ISL (NAF waste rock)	NAF WRD 1,750,000 m <sup>3</sup>	End dumping followed by smoothing No compaction
	0.5	RPL (NAF waste rock)	NAF WRD 1,750,000 m <sup>3</sup>	End dumping Grading Compaction to ~95% of maximum dry density
	0.4	CB (NAF waste rock)	NAF WRD 1,750,000 m <sup>3</sup>	Described in Appendix D

**Figure 7 Cover cross section**

## 4.2 Preliminary cover model

The purpose of this section is to summarise the preliminary modelling that was completed to determine the most suitable store and release cover options for the TSF. These would then progress to cover trials. The following was used to undertake a cover options analysis (Appendix D):

- cover priorities and purpose;
- cover desirable attributes;
- the environmental risk assessment;
- cover materials available; and
- current available technology.

The top three ranked covers (cover option 1, 2 and 3) were then used in the preliminary modelling. Cover option 4 was also modelled to assess how thick the ISL should be and to investigate whether a RPL or CB is required. It is important to note that the model is uncalibrated and requires monitoring data for infiltration and seepage from field trials before the final decision on cover thickness can be made. The methodology and rationale behind the covers examined in the preliminary modelling is shown in Appendix D.

Cover option 1 is the cover specified in the EIS and is the primary design for rehabilitation of the TSF and includes:

- a 0.4 m CB layer of gap-graded NAF waste rock;
- a 0.5 m RPL of NAF waste rock above the CB layer;
- a 1 m ISL of NAF waste rock above the RPL; and
- a 0.2 m topsoil layer above the ISL.

Cover option 2 is the cover that discussions with DES have indicated is DES' preferred cover:

- a 0.6 m CB layer comprised of 0.3 m of gap-grade gravel overlain by 0.3 m of clean filter sand;
- a 0.5 m RPL of NAF waste rock above the CB layer;
- a 1 m ISL of NAF waste rock above the RPL; and
- a 0.2 m topsoil layer above the ISL.

Cover option 3 is the cover that discussions with DES have indicated is DES' preferred cover with an ISL half the thickness of cover option 2. The aim of this was to explore the effect of a thinner ISL and includes:

- a 0.6 m CB layer comprised of 0.3 m of gap-grade gravel overlain by 0.3 m of clean filter sand;
- a 0.5 m RPL of NAF waste rock above the CB layer;
- a 0.5 m ISL of NAF waste rock above the RPL; and
- a 0.2 m topsoil layer above the ISL.

Cover option 4 aims to explore the effects of no CB or RPL and includes:

- a 0.5 m ISL of NAF waste rock; and
- a 0.2 m topsoil layer above the ISL.

The model was initially run for a 128-year period using patched climate data from SILO (Scientific Information for Landowners) for Cloncurry Airport (the primary model run). The model was then run for a dry, average and wet year based on the 128-year patched SILO climate data.

### 4.2.1 Results

The model has been used to develop a water balance for cover option 1 and alternative cover options for the average, dry and wet year model scenarios, presented in Table 14 to Table 17.

**Table 14 Summary of primary cover (cover option 1) water balance for average, wet and dry years**

	<b>Dry year</b>	<b>Average year</b>	<b>Wet year</b>
Rainfall (mm)	307	460	1,156
Stored infiltration (%)	5	3	27
Seepage (%)	0.9	1	6
Actual evaporation (%)	94.1	96	67

**Table 15 Summary of cover option 2 water balance for average, wet and dry years**

	<b>Dry year</b>	<b>Average year</b>	<b>Wet year</b>
Rainfall (mm)	307	460	1,156
Stored infiltration (%)	4.7	3	32.1
Seepage (%)	0.01	1	0.1
Actual evaporation (%)	95.3	96	67.8

**Table 16 Summary of cover option 3 water balance for average, wet and dry years**

	<b>Dry year</b>	<b>Average year</b>	<b>Wet year</b>
Rainfall (mm)	307	460	1,156
Stored infiltration (%)	4.2	15.1	10.1
Seepage (%)	2.8	16	33.2
Actual evaporation (%)	93	68.9	56.7

**Table 17 Summary of cover option 4 water balance for average, wet and dry years**

	<b>Dry year</b>	<b>Average year</b>	<b>Wet year</b>
Rainfall (mm)	307	460	1,156
Stored infiltration (%)	1.2	11.6	8.2
Seepage (%)	3	20.6	36
Actual evaporation (%)	95.2	67.8	55.8

The results (Table 14 to Table 17) show that during dry periods, the Primary Cover and alternative cover options are all expected to limit seepage to less than the rate of natural groundwater recharge (Cook et al. 2004). However, the average year results indicate that seepage through alternative cover option 3 and 4 will exceed the rate of natural groundwater recharge. Further, the rate of seepage will continue to increase during wet periods to a maximum of 36% of rainfall. Therefore, it is likely that alternative cover options 3 and 4 will periodically have unacceptably high seepage rates. The expected high seepage rate is unlikely to result in successful rehabilitation of the TSF due to a very-high water management demand. Finally, it is also considered unlikely that alternative cover option 3 or 4 will retain enough PAWC to allow sustained vegetation growth on the TSF cover. A reduced PAWC for a cover less than 0.5 m is supported by PAWC analysis of soil (Section 3.2.2.2b and Section 3.2.2.3b).

As would be reasonably expected, the wet year model scenario does result in an increase in potential seepage for cover option 1 and 2. However, for both covers the seepage rate is in line with other Australian cover examples (Section 6.2.3) and is less than the rate of natural groundwater recharge (Cook et al. 2004). Further, the model also suggests that a CB will also help to limit the potential for seepage because the air-filled voids of the CB will act as a physical barrier to infiltration.

## 4.2.2 Preferred cover option

Based on the preliminary model results, the preferred cover option is alternative cover option 2.

## 4.3 Final cover options to trial

The availability of NAF waste rock for use in the TSF cover is unknown at this stage. Borrow subsoil was identified as a potential alternative material for use in the ISL and RPL. This material was therefore trialled in place of NAF waste rock in the trials. Cover options 1, 2, 3 and 4 were all progressed to column trials as per Section 4.2 with the NAF waste rock ISL and RPL substituted for a borrow subsoil ISL and RPL.

## 5.0 Column Cover Trials

---

The low rainfall environment of the Mine was seen as a limiting factor to achieving a timely response from potential cover trials. Regional experience indicates that several years of data would be required to capture a representative window of how the cover responds to seasonal changes. Space availability on the TSF to construct the trials is also a limiting factor. In order to achieve interim data of cover performance, it was decided that the cover trials would be constructed as large columns. This approach allowed the Mine to decide the frequency and quantity of rainfall, providing greater capacity to develop a maximum water balance for each column trial quickly.

The trials were instrumented with volumetric water content sensors (also capable of measuring electrical conductivity) and matric suction sensors to measure how rainfall infiltration and dissolved ions are stored within the cover (Section 5.1.4). Matric suction and volumetric water content data are used to form soil water characteristic curves for each of the materials in the covers. These curves describe the behaviour of water storage and movement and are a key input required for the model (Section 6.0). Seepage was measured using rain gauge tipping buckets (Section 5.1.2.1). All this data, combined with the back-calculated evaporation rate (EQN4), gives a maximum water balance which will be used to validate the accuracy of the model (Section 5.2.3)

### 5.1 Method

#### 5.1.1 Sensor calibrations

The trials were instrumented with VWC and matric suction sensors. The following sections describe how the sensors were calibrated prior to installation.

##### 5.1.1.1 Matric suction sensors

###### a Theory

The matric suction sensors consist of a heating and reference wire surrounded by sintered ceramic (the components). The sintered ceramic is porous and when buried in the trial will wet and dry in response to wetting and drying of the trial. The matric suction sensor infers how wet or dry the sintered ceramic, and hence the cover is, daily by measuring the temperature of the reference wire at one second followed by 30 seconds of heating of the heater wire followed by a final measure of the reference wire at 30 seconds. How hot the reference wire becomes is a function of the cover. That is, how wet or dry the sintered ceramic is. For example, if the sintered ceramic is wet then it will heat more slowly, and hence to a lesser extent, compared to if the sintered ceramic was dry. Matric suction sensors require calibration so that an empirical relationship between change in temperature ( $\Delta T$ ) and matric suction can be developed for each sensor prior to installation in the trials.

###### b Calibration set-up

The matric suction sensors were calibrated in either soil, borrow subsoil or tailings, correlating to their depth of burial within the trials.

Matric suction sensors were individually calibrated by comparing the measured  $\Delta T$  of the matric suction sensor to the matric suction of the soil or tailings. The matric suction of the soil or tailings was determined by measuring total suction with a dew-point water potential meter and calculating osmotic suction from EC. Matric suction was then calculated by subtracting osmotic suction from total suction.

The method used for calibration of the matric suction sensors is presented in Appendix E.

The derived calibrations apply to:

- dewatering of sensors, and do not account for hysteresis; and
- constant temperature and humidity conditions, as applied during the calibration process.

## c Results

Calibration functions for each trial are presented in Appendix F. Campbell Scientific matric suction sensors are recommended for use for matric suctions ranging from 10-1,000 kilopascals (kPa). These sensors are regularly calibrated for suctions greater than 1,000 kPa (Flint et al. 2002). The calibration functions presented extended up to 1,000,000 kPa, it is however unlikely that matric suctions of this order will ever be achieved in the field. The expected range for environmental conditions at the Mine are likely to extend from 10 kPa to approximately 100,000 kPa, corresponding to wet and dry seasons respectively.

### 5.1.2 Construction

Four columns, one for each cover option, were built to specifications provided by SGME. A built column is shown in Photograph 1. Columns ranged from 1.1 m to 2.5 m tall depending on the thickness of the cover trialled. Each column has a surface area of 0.25 metres squared (m<sup>2</sup>).



**Photograph 1 Cover column trial**

#### 5.1.2.1 Seepage volume

The columns include a flume on their base so that seepage can be captured. Rain gauge tipping buckets were placed under the flumes to measure the volume of seepage. The rain gauge tipping buckets sit on-top of a collection reservoir which allows seepage water to be collected. Seepage chemistry was not analysed during the trials.

### 5.1.3 Filling

The trials are made up of layers of soil, waste rock and tailings which are described in the following sections.

A 0.1 m layer of clean gravel was placed on the bottom of each trial to act as a drainage layer (the filter layer). Geofabric was placed on top of the filter layer to prevent tailings from clogging it by migrating into the gravel pore spaces. Geofabric was also placed over drainage tap openings to further assist in stopping potential migration of fines.

It should be noted that the tailings in the bottom of each column are compacted to greater than 100% of MDD (Section 3.1.3) to mimic the potential compaction that may result from continuous compaction during cover construction on the TSF.

#### 5.1.3.1 EIS cover (cover option 1)

Cover option 1 is the cover specified in the EIS and is the primary design for rehabilitation of the TSF and includes:

- a 0.3 m layer of fresh tailings above the filter layer compacted to a bulk density of 2.19 t/m<sup>3</sup>. The target density was achieved by compacting eight, 20.5 kilogram (kg) buckets of tailings into 0.08 m<sup>3</sup>. No sensors were placed in the tailings.
- a 0.4 m CB layer of gap-graded NAF waste rock above the tailings layer at a density of 1.43 t/m<sup>3</sup>. The target density was achieved by compacting seven, 20.4 kg buckets of air-dry NAF waste rock into 0.1 m<sup>3</sup>. One sensor pair was placed in the middle of this layer (Figure 8).
- a 0.5 m RPL of borrow subsoil above the CB layer at a density of 2.31 t/m<sup>3</sup>. The target density was achieved by compacting 14, 20.65 kg buckets of air-dry NAF waste rock into 0.125 m<sup>3</sup>. One sensor pair was placed at the top and bottom of this layer (Figure 8).
- a 1 m ISL of borrow subsoil above the RPL at a density of 1.64 t/m<sup>3</sup>. This was achieved by compacting 20, 20.5 kg buckets of air-dry NAF waste rock into 0.25 m<sup>3</sup>. One sensor pair was placed at the bottom of this layer (Figure 8).
- a 0.2 m topsoil layer above the ISL at a density of 1.7 t/m<sup>3</sup>. This was achieved by compacting four, 21.5 kg buckets of topsoil into 0.05 m<sup>3</sup>. One sensor pair was placed at the bottom of this layer (Figure 8).

#### 5.1.3.2 DES cover (cover option 2)

Cover option 2 is the cover option preferred by DES and includes:

- a 0.1 m layer of fresh tailings above the filter layer compacted to a bulk density of 2.4 t/m<sup>3</sup>. The target density was achieved by compacting three, 20 kg buckets of tailings into 0.025 m<sup>3</sup>. No sensors were placed in the tailings.
- a 0.3 m CB layer of gap-graded NAF waste rock above the tailings layer at a density of 1.38 t/m<sup>3</sup>. The target density was achieved by compacting five, 20.8 kg buckets of air-dry NAF waste rock into 0.075 m<sup>3</sup>. One sensor pair was placed in the middle of this layer (Figure 8).
- a 0.5 m RPL of borrow subsoil above the CB layer at a density of 2.27 t/m<sup>3</sup>. The target density was achieved by compacting 14, 20.31 kg buckets of air-dry NAF waste rock into 0.125 m<sup>3</sup>. One sensor pair was placed at the top and bottom of this layer (Figure 8).
- a 0.3 m CB layer of gap-graded NAF waste rock above the RPL at a density of 1.38 t/m<sup>3</sup>. The target density was achieved by compacting five, 20.8 kg buckets of air-dry NAF waste rock into 0.075 m<sup>3</sup>. One sensor pair was placed in the middle of this layer (Figure 8).
- a 1 m ISL of borrow subsoil above the CB layer at a density of 1.64 t/m<sup>3</sup>. This was achieved by compacting 20, 20.5 kg buckets of air-dry NAF waste rock into 0.25 m<sup>3</sup>. One sensor pair was placed in the middle of this layer (Figure 8).
- a 0.2 m topsoil layer above the ISL at a density of 1.7 t/m<sup>3</sup>. This was achieved by compacting four, 21.5 kg buckets of topsoil into 0.05 m<sup>3</sup>. No sensors were placed in the topsoil.



### 5.1.3.3 DES cover with a half thickness ISL (cover option 3)

Cover option 3 is the preferred DES cover option with an ISL half the thickness of cover option 2. The aim of this was to explore the effect of a thinner ISL and includes:

- a 0.4 m layer of fresh tailings above the filter layer compacted to a bulk density of 2.03 t/m<sup>3</sup>. The target density was achieved by compacting 10, 20.34 kg buckets of tailings into 0.1 m<sup>3</sup>. No sensors were placed in the tailings.
- a 0.3 m CB layer of gap-graded NAF waste rock above the tailings layer at a density of 1.35 t/m<sup>3</sup>. The target density was achieved by compacting five, 20.26 kg buckets of air-dry NAF waste rock into 0.075 m<sup>3</sup>. One sensor pair was placed at the top of this layer (Figure 8).
- a 0.5 m RPL of borrow subsoil above the CB layer at a density of 2.27 t/m<sup>3</sup>. The target density was achieved by compacting 14, 20.27 kg buckets of air-dry NAF waste rock into 0.125 m<sup>3</sup>. One sensor pair was placed at the top and bottom of this layer (Figure 8).
- a 0.3 m CB layer of gap-graded NAF waste rock above the RPL at a density of 1.38 t/m<sup>3</sup>. The target density was achieved by compacting five, 20.49 kg buckets of air-dry NAF waste rock into 0.075 m<sup>3</sup>. One sensor pair was placed in the middle of this layer (Figure 8).
- a 0.5 m ISL of borrow subsoil above the CB layer at a density of 1.59 t/m<sup>3</sup>. This was achieved by compacting 10, 19.82 kg buckets of air-dry NAF waste rock into 0.125 m<sup>3</sup>. One sensor pair was placed at the top of this layer (Figure 8).
- a 0.2 m topsoil layer above the ISL at a density of 1.7 t/m<sup>3</sup>. This was achieved by compacting four, 21.5 kg buckets of topsoil into 0.05 m<sup>3</sup>. No sensors were placed in the topsoil.

### 5.1.3.4 ISL cover (cover option 4)

Cover option 4 aims to explore the effects of no CB or RPL and includes:

- a 0.3 m layer of fresh tailings above the filter layer compacted to a bulk density of 2.15 t/m<sup>3</sup>. The target density was achieved by compacting 10, 20.12 kg buckets of tailings into 0.075 m<sup>3</sup>. One sensor pair was placed at the top and bottom of this layer (Figure 8).
- a 0.5 m ISL of borrow subsoil above the tailings layer at a density of 1.62 t/m<sup>3</sup>. This was achieved by compacting 10, 20.2 kg buckets of air-dry NAF waste rock into 0.125 m<sup>3</sup>. One sensor pair was placed at the top and bottom of this layer (Figure 8).
- a 0.2 m topsoil layer above the ISL at a density of 1.7 t/m<sup>3</sup>. This was achieved by compacting 4, 21.5 kg buckets of topsoil into 0.05 m<sup>3</sup>. One sensor pair was placed in the middle of this layer (Figure 8).

## 5.1.4 Installation of instruments

The trials included buried sensor pairs in the topsoil, ISL, CB, RPL and tailings layers. The sensor pairs comprise a matric suction sensor and a VWC sensor. The trials have five pairs of VWC and matric suction sensors buried at the depths shown in Figure 8.

**Cover option 1**

Sensor number	Burial depth
1-1	0.3 m
1-2	1.2 m
1-3	1.4 m
1-4	1.7 m
2-10	2 m

**Cover option 2**

Sensor number	Burial depth
1-6	0.7 m
1-7	1.5 m
1-8	1.7 m
1-9	2 m
1-10	2.2 m

**Cover option 3**

Sensor number	Burial depth
2-1	0.5 m
2-2	1 m
2-3	1.2 m
2-4	1.5 m
2-5	1.7 m

**Cover option 4**

Sensor number	Burial depth
2-6	0.3 m
2-7	0.5 m
2-8	0.7 m
2-9	0.9 m
1-5	1 m

Notes: 1. Light brown = topsoil, orange = ISL, reddish brown = RPL, green = CB, grey = tailings

**Figure 8 Burial depth of sensors**

### 5.1.5 Wetting and drying

The trials were subjected to 12 artificial rainfall events over 6 months. The purpose of the artificial rainfall was to allow the trials to wet up and dry out so that soil water characteristic curves and a maximum water balance could be developed for each cover:

- 30 mm simulated rainfall on day 2;
- 30 mm simulated rainfall on day 15;
- 30 mm simulated rainfall on day 28;
- 30 mm simulated rainfall on day 42;
- 30 mm simulated rainfall on day 56;
- 30 mm simulated rainfall on day 70;
- 30 mm simulated rainfall on day 97;
- 100 mm simulated rainfall on day 112;
- 200 mm simulated rainfall on day 125;
- 200 mm simulated rainfall on day 144 to cover options 1, 2 and 3 only; and
- 200 mm simulated rainfall on day 158 to cover options 1 and 2 only.

This equates to a total of 910 mm of artificial rainfall applied to cover options 1 and 2, 710 mm of artificial rainfall to cover option 3 and 510 mm of artificial rainfall applied to cover option 4. The total artificial rainfall applied to each cover varied due to the varying thicknesses and materials of the different covers and the subsequent requirements to generate appropriate wetting up and drying out data.

During wetting events, artificial rainfall could pond on the surface of the trials (Photograph 2).



**Photograph 2 Ponding of water on the trials**

## 5.2 Results and discussion

### 5.2.1 Stored infiltration

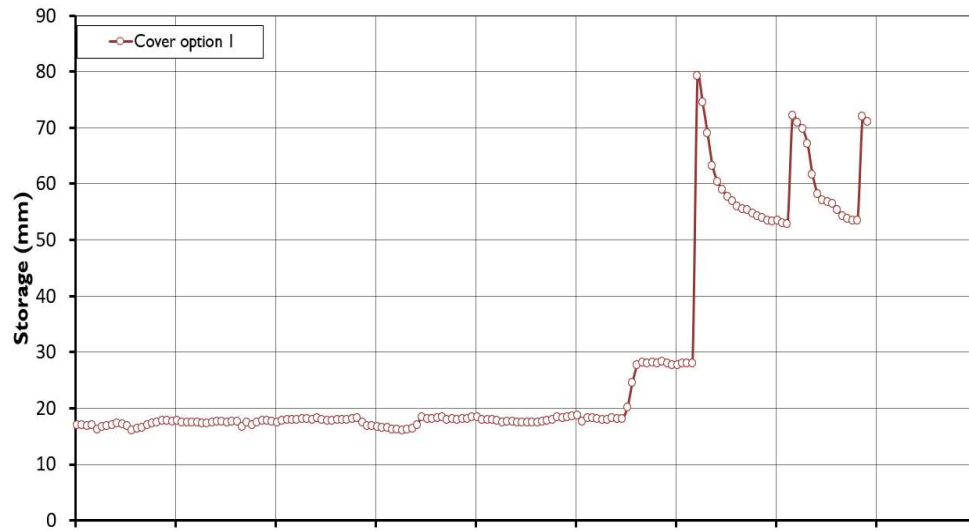
Stored infiltration in the trials can be calculated daily by multiplying the change in VWC by depth. The daily incremental change in stored infiltration ( $\Delta SW$ ) balances the infiltration budget daily as either wetting (+ve  $\Delta SW$ ) or drying (-ve  $\Delta SW$ ). As such, it is proportional to the rate of evaporation. Figure 9 presents the stored infiltration for the trials.

In Figure 9:

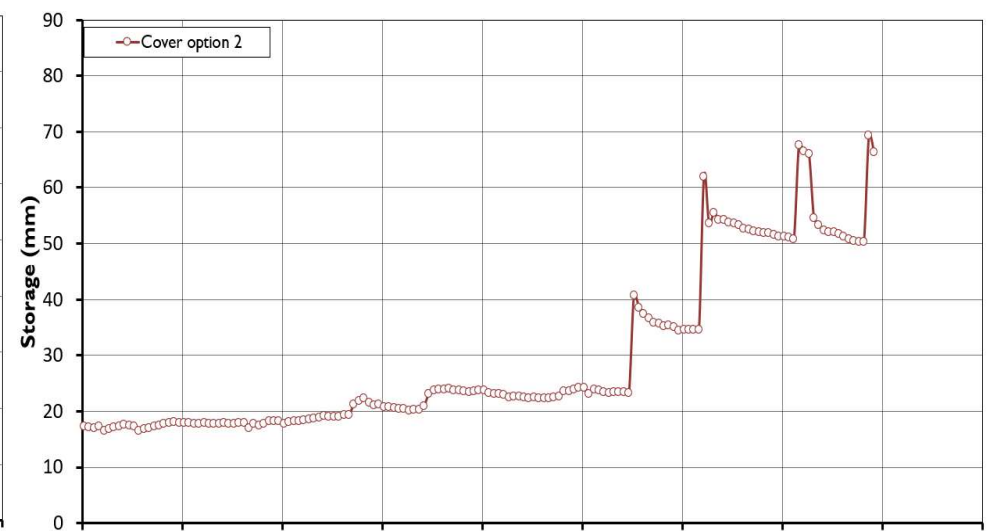
- Figure 9a shows the stored infiltration of cover option 1;
- Figure 9b shows the stored infiltration of cover option 2;
- Figure 9c shows the stored infiltration of cover option 3; and
- Figure 9d shows the stored infiltration of cover option 4.

Of the four trials, cover option 2 stores the most total infiltration (~ 48 mm) followed by cover option 1 (~ 39 mm) and cover option 3 (~37 mm), while cover option 4 stores the least infiltration (~ 20 mm).

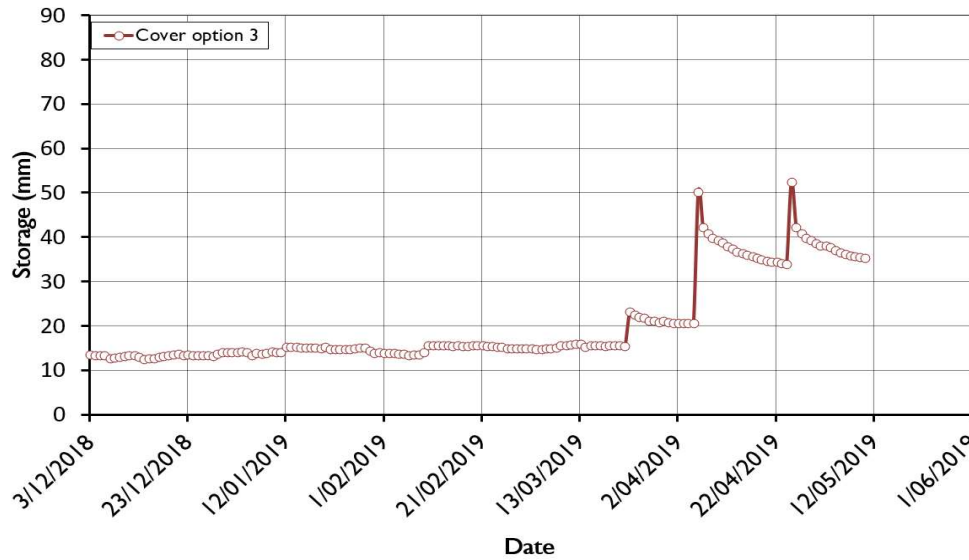
Note that delays in stored infiltration being detected in the columns (following watering events) are likely due to bypass flow initially occurring in macro-pores. This typically occurs faster than the gradual wetting up and flow in the soil matrix (ie matrix flow). Evaporation of ponded water from the top of the trials may also be contributing to this pattern.



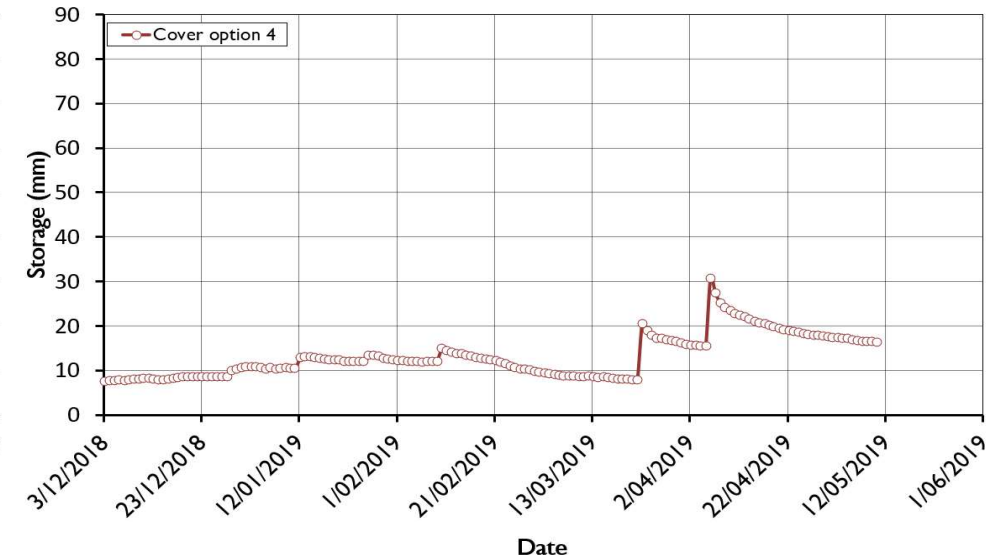
(a)



(b)



(c)



(d)

**Figure 9** Stored infiltration in the trials

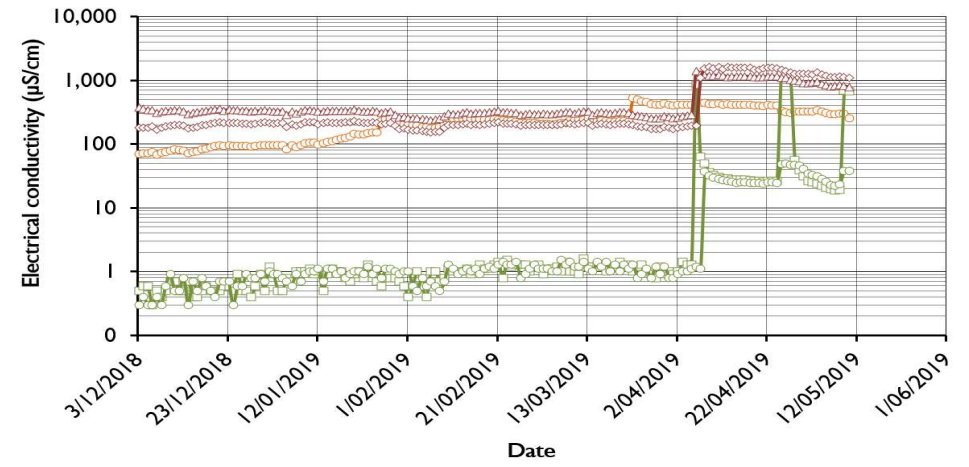
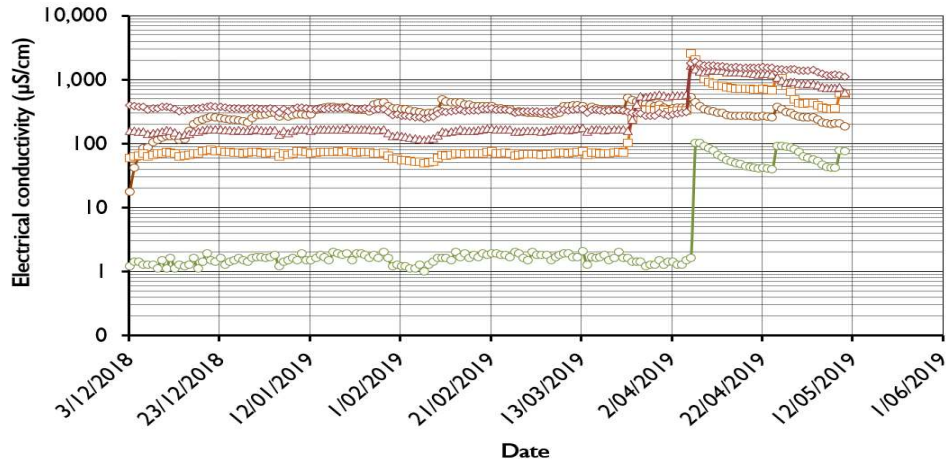
## 5.2.2 EC

The trials have not shown any signs of significant capillary rise (Figure 10). The rises in EC observed in Figure 10 correlate with increasing VWC (thereby dissolving existing salts in the cover) and are not as a result of capillary rise from the tailings.

The trials will need to be moved outside and monitored for an extended period of time to fully evaluate the potential for capillary rise and the subsequent need for a CB. This will expose the trials to natural rates of rainfall (ie lower than that what was artificially applied) and a higher evaporation rate (therefore a higher potential for capillary rise) (see Section 7.1).

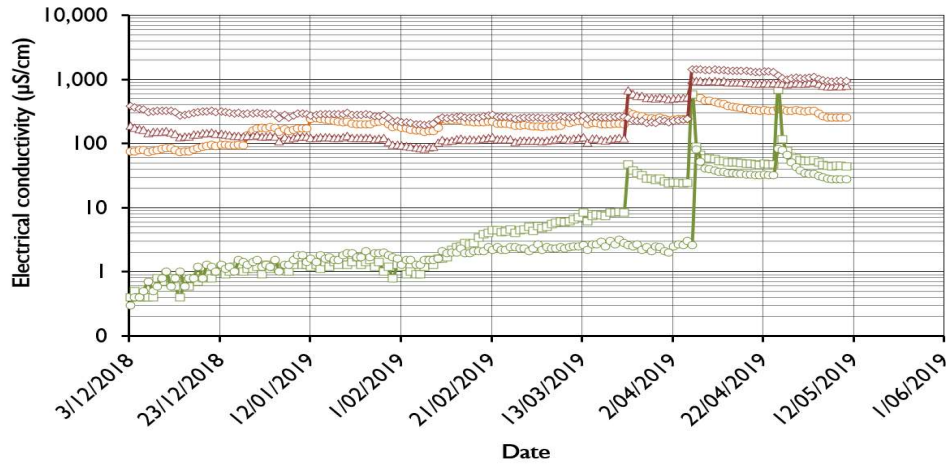
In Figure 10:

- Figure 10a shows the EC of cover option 1;
- Figure 10b shows the EC of cover option 2;
- Figure 10c shows the EC of cover option 3; and
- Figure 10d shows the EC of cover option 4.

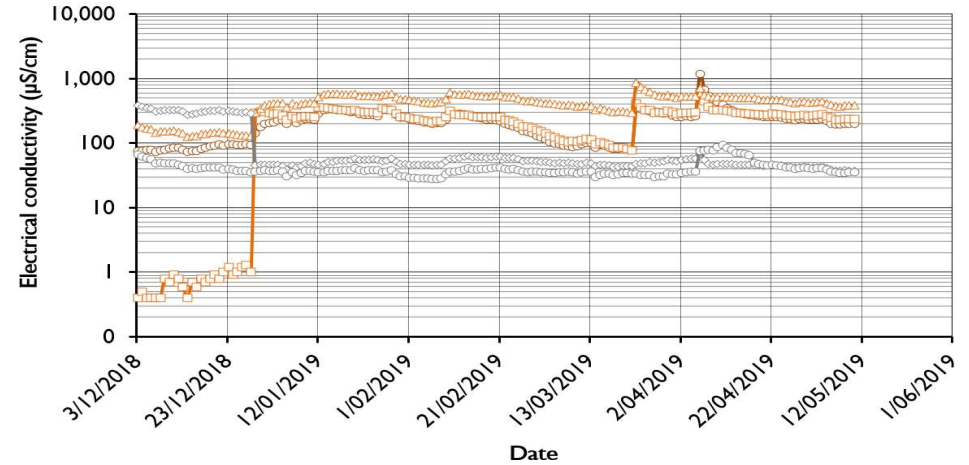


(d)

(b)



(c)



(d)

Figure 10 Electrical conductivity of the trials



### 5.2.3 Water balance

Incorporating stored infiltration, artificial rainfall and seepage allows for the calculation of a water balance for each trial by solving for evaporation using EQN4:

$$\text{Evaporation} = \text{Artificial rainfall} - \text{seepage} - \text{stored infiltration} \quad [\text{EQN4}]$$

Table 18 summarises the maximum water balance for the trials.

Seepage results are only included in Table 18 to complete the maximum water balance for the trials. The seepage results are not comparable between trials as the artificial rainfall applied varied between each cover option. Seepage results are therefore not indicative of potential future cover performance. A scenario whereby all columns experience 710 mm of artificial rainfall (ie the rainfall applied to cover option 3) has been modelled in Section 6.2.1. Future cover performance has also been modelled in Section 6.2.2.

**Table 18 Maximum water balance for each cover thickness**

Cover thickness	Flux	Flux	
		Units	(% of cumulative artificial rainfall)
Cover option 1	Store infiltration	54.1	5.9
	Seepage	133.7	14.7
	Evaporation	722.3	79.4
Cover option 2	Store infiltration	49	5.4
	Seepage	244.5	26.9
	Evaporation	616.5	67.7
Cover option 3	Store infiltration	21.7	3.1
	Seepage	50.9	7.2
	Evaporation	637.3	89.8
Cover option 4	Store infiltration	9.5	1.9
	Seepage	0.9	0.2
	Evaporation	499.6	98

# 6.0 Semi-calibrated SVFlux modelling

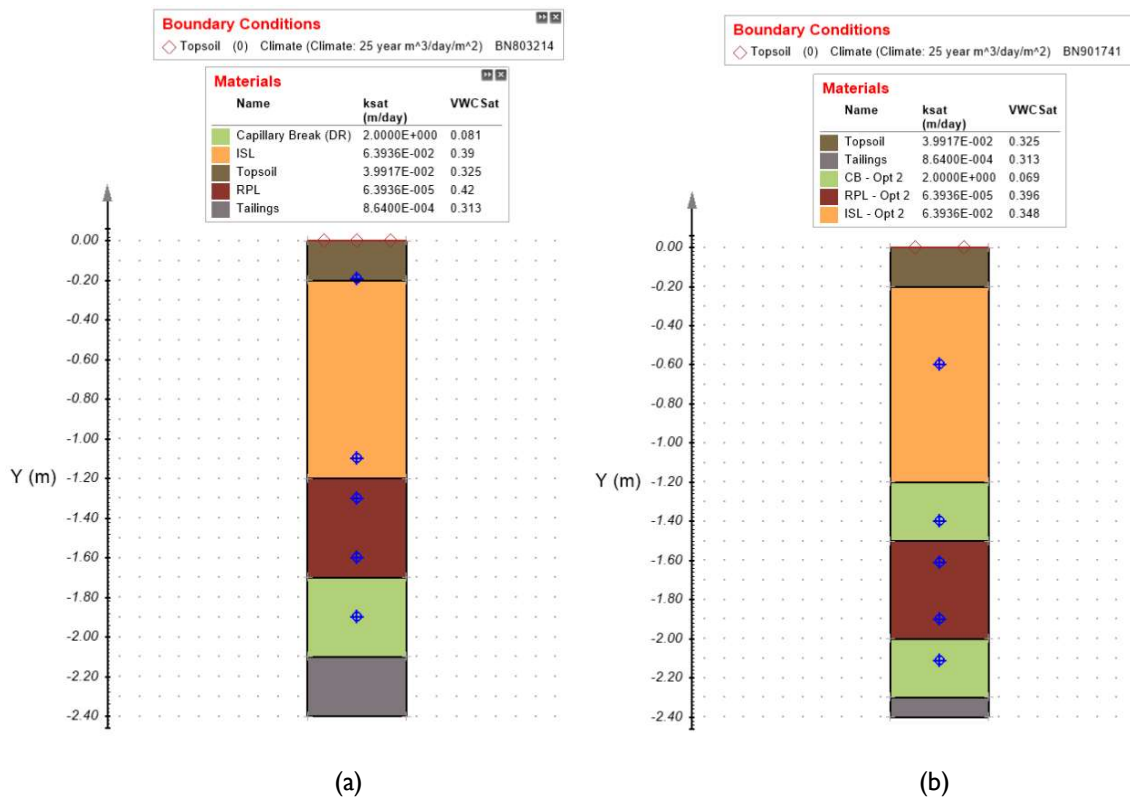
## 6.1 Method

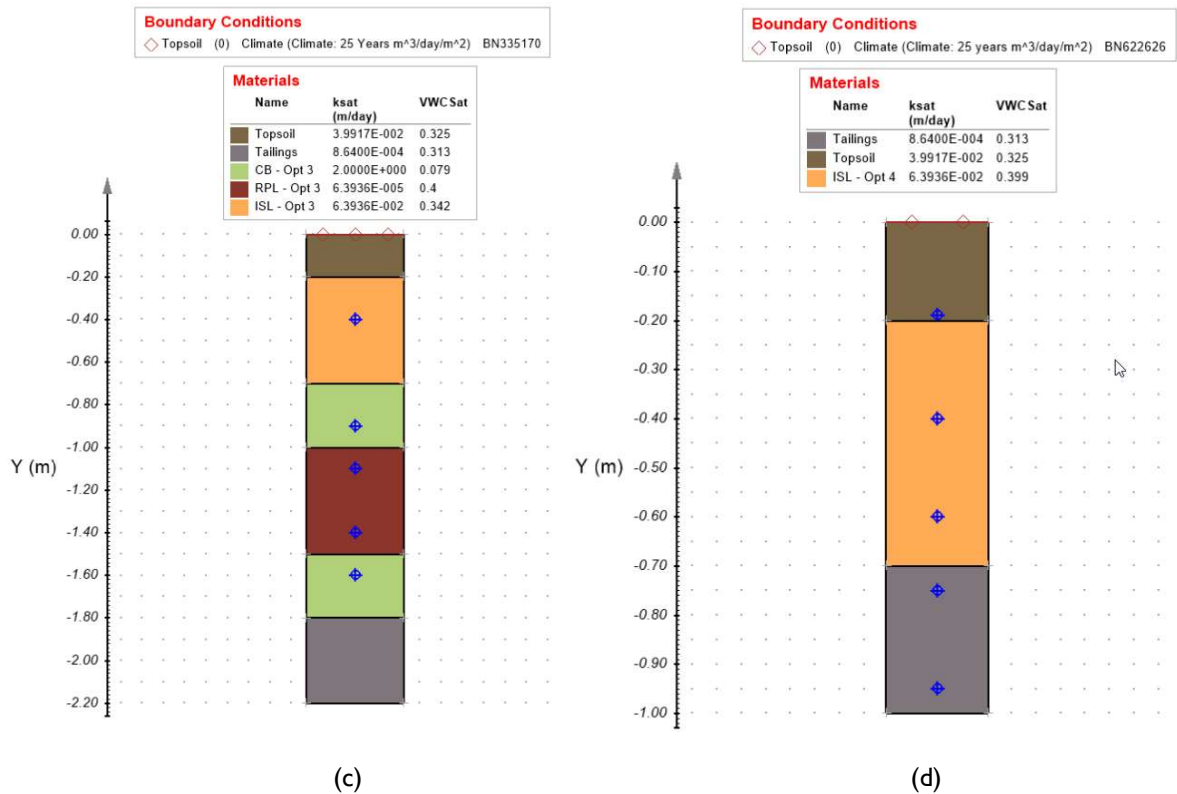
The model was developed in one dimension and calculates the upward and downward movement of rainfall infiltration and seepage in the trials; it assumes no surface runoff or run on and allows ponding at the surface of the cover (Photograph 2).

Transpiration from vegetation has been conservatively excluded since data is not available for this parameter ie the model only considers evaporation.

### 6.1.1 Model dimensions

The models were developed to replicate the trials, that is varying ISL thicknesses, with and without RPLs and/or CBs. Cover option 1-4 are shown in Figure 11a-d respectively.





**Figure 11 Model dimensions**

## 6.1.2 Mesh geometry

The model automatic mesh generation and automatic mesh refinement algorithms were used to generate the finite element mesh in the model.

## 6.1.3 Initial conditions

### 6.1.3.1 Evaporation

Potential evaporation in the model was kept as a constant at 0.0035 m/day. The potential evaporation rate is the average for the four trials.

### 6.1.3.2 Physical characteristics

#### a SWCCs

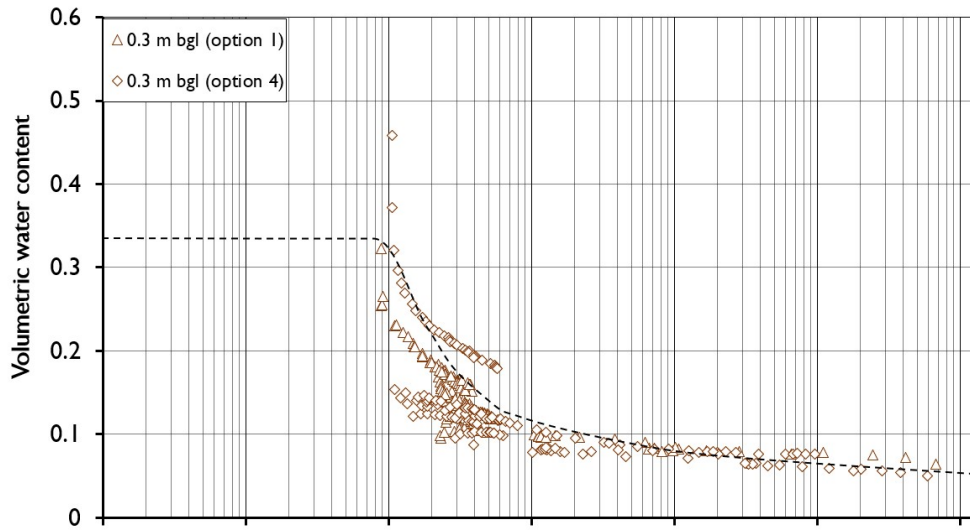
The model requires SWCCs. A SWCC is the relationship between VWC and matric suction for each depth where the sensors are placed in the cover (the in-situ results).

The in-situ SWCCs for the ISL, RPL, topsoil and CB were fitted to the in-situ results using the Fredlund & Xing (1994) method (Figure 13). The SWCC for the underlying tailings was derived from the PSD using pedotransfer functions (Fredlund and Xing 1994). This was due to the in-situ results not generating a complete SWCC (ie the relationship between VWC and matric suction in the tailings was not fully defined).

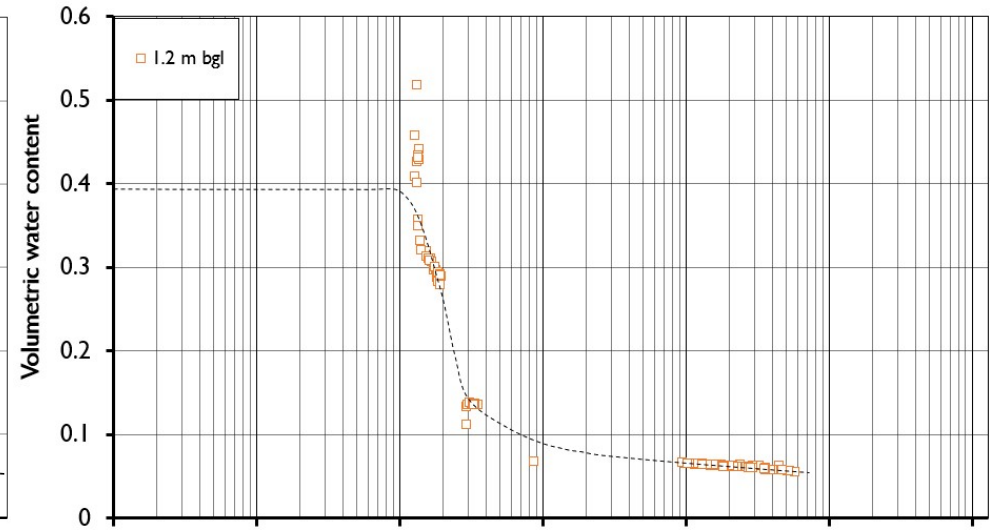
In Figure 13:

- Figure 13a is the topsoil SWCC for all of the trials;
- Figure 13b is the ISL SWCC for cover option 1;

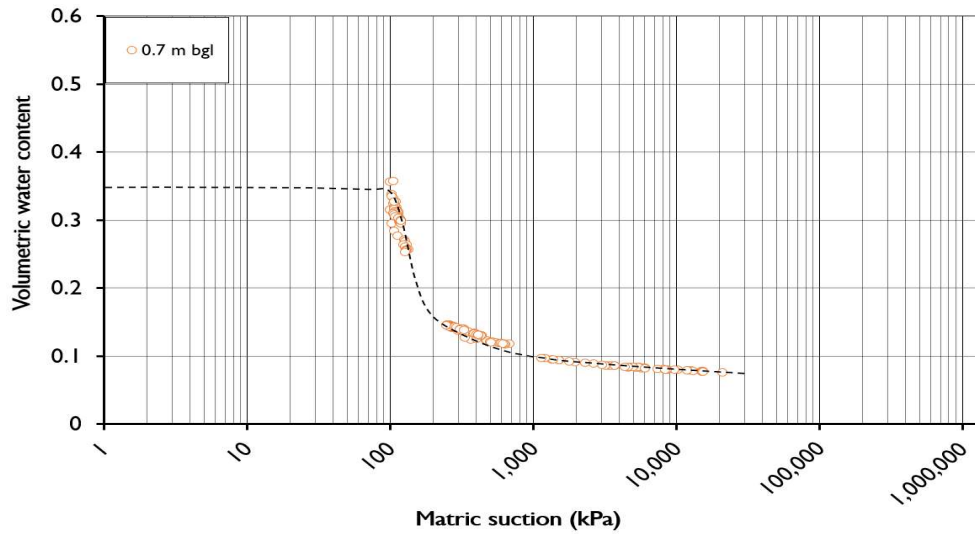
- Figure 13c is the ISL SWCC for cover option 2;
- Figure 13d is the ISL SWCC for cover option 3;
- Figure 13e is the ISL SWCC for cover option 4;
- Figure 13f is the CB SWCC for cover option 1;
- Figure 13g is the CB SWCC for cover option 2;
- Figure 13h is the CB SWCC for cover option 3;
- Figure 13i is the RPL SWCC for cover option 1;
- Figure 13j is the RPL SWCC for cover option 2;
- Figure 13k is the RPL SWCC for cover option 3; and
- Figure 13l is the tailings SWCC for all of the trials;



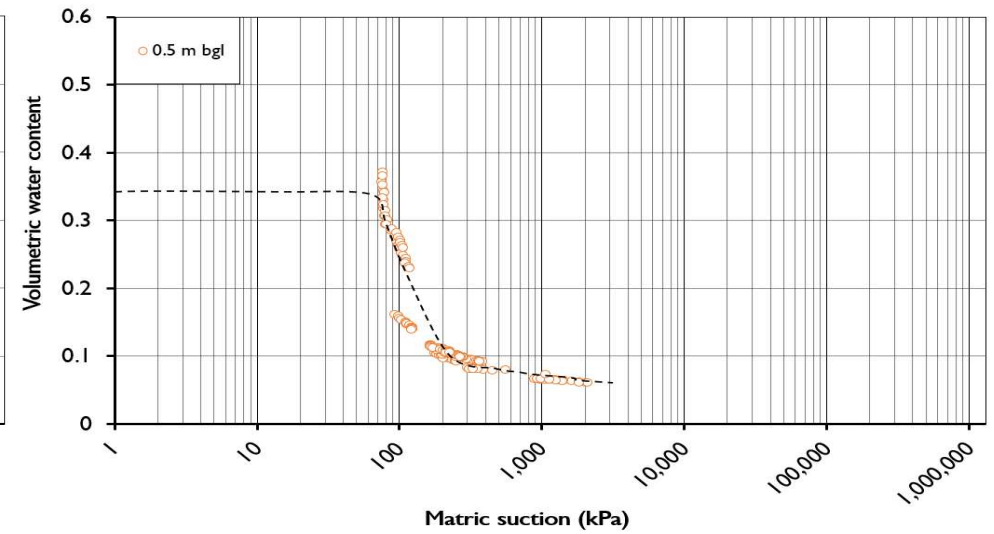
(a)



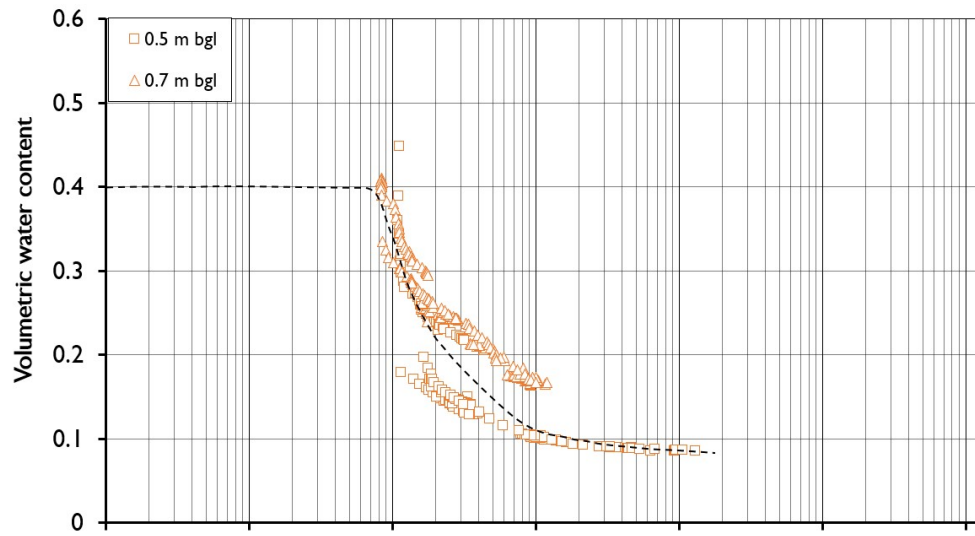
(b)



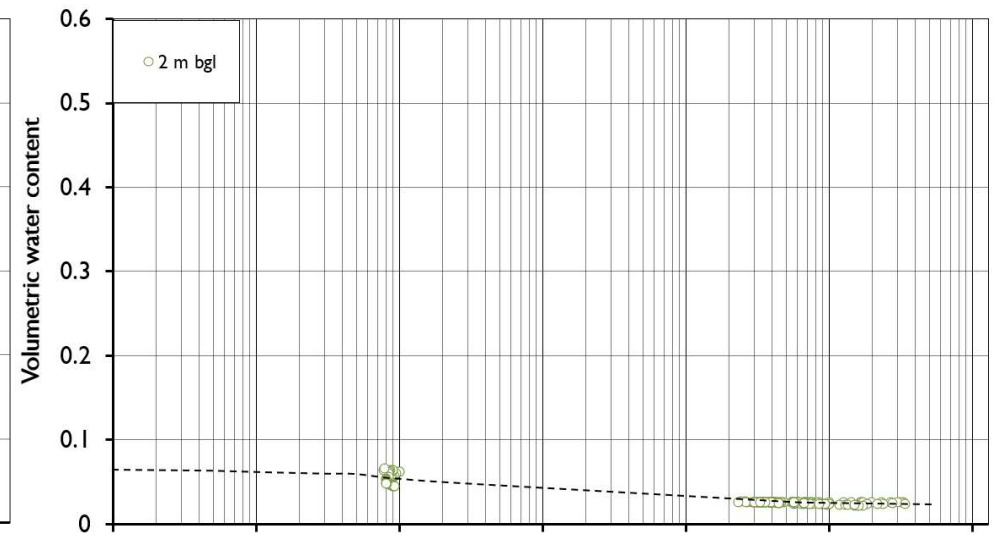
(c)



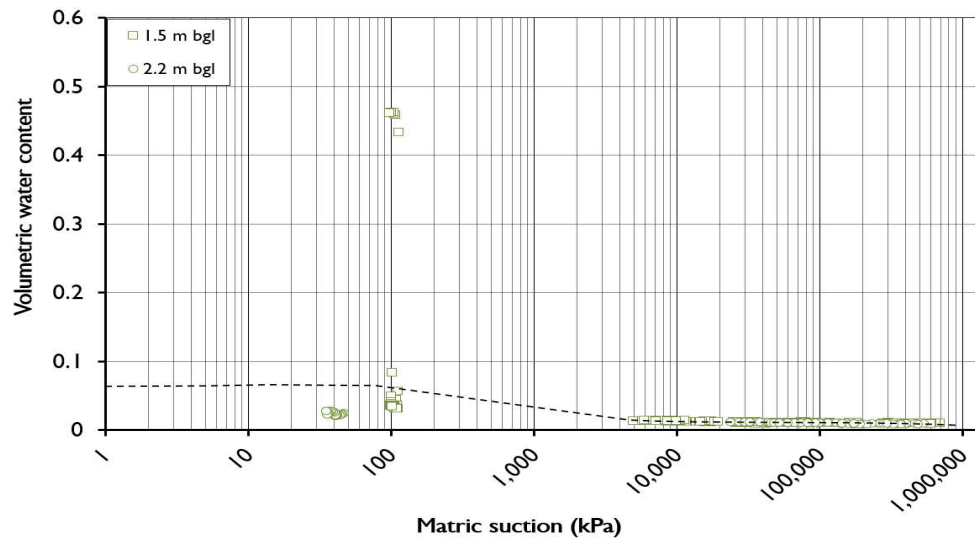
(d)



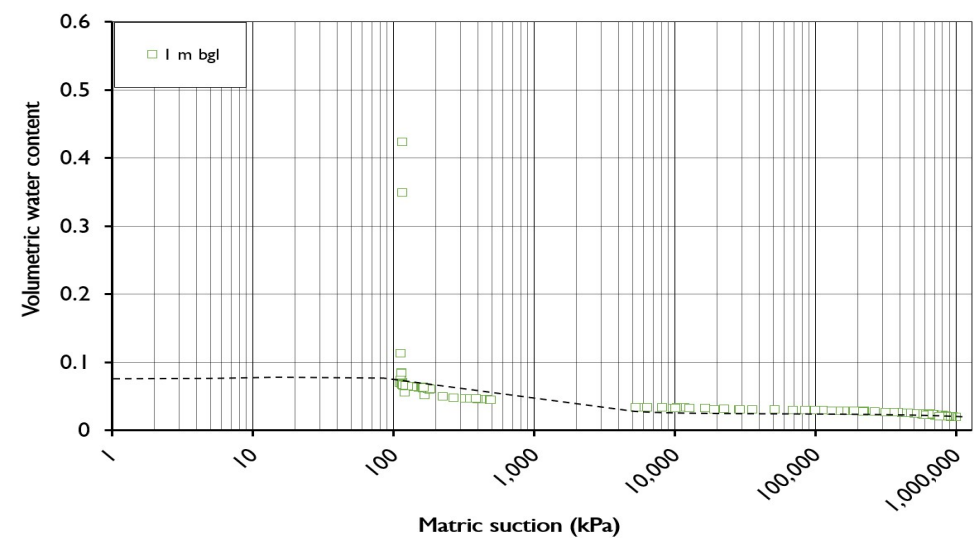
(e)



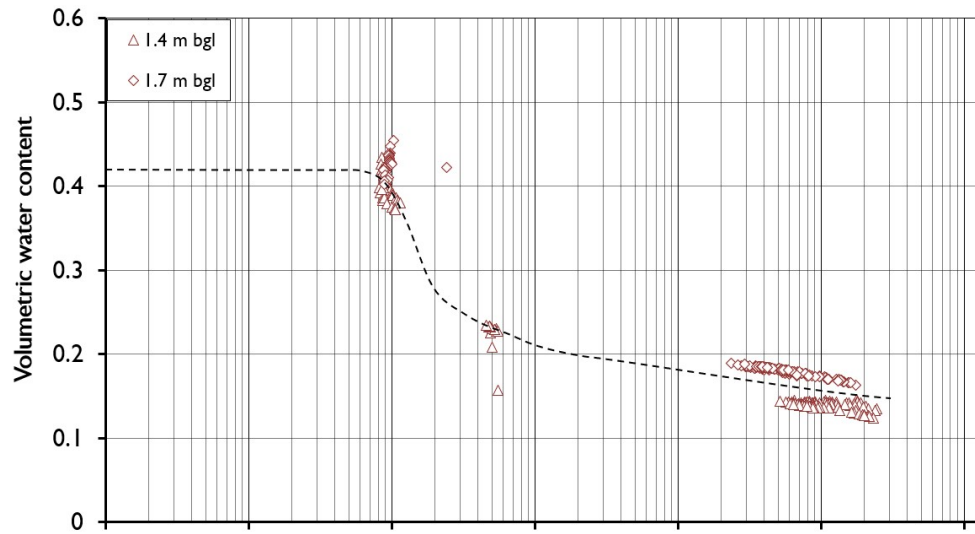
(f)



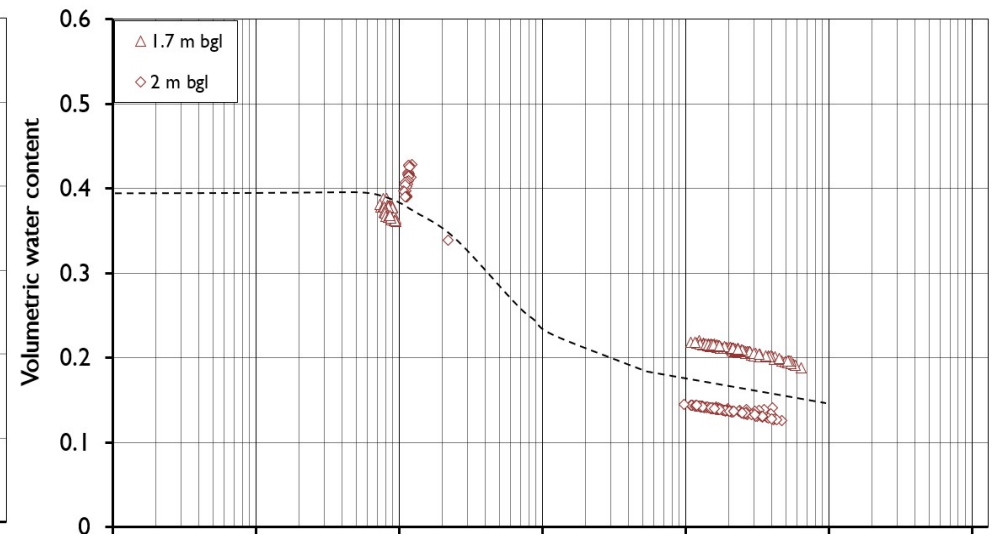
(g)



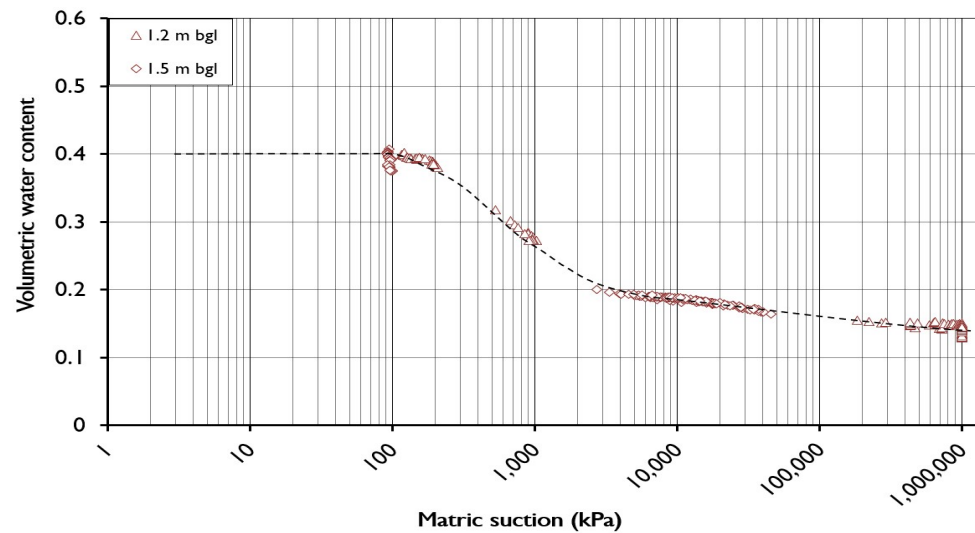
(h)



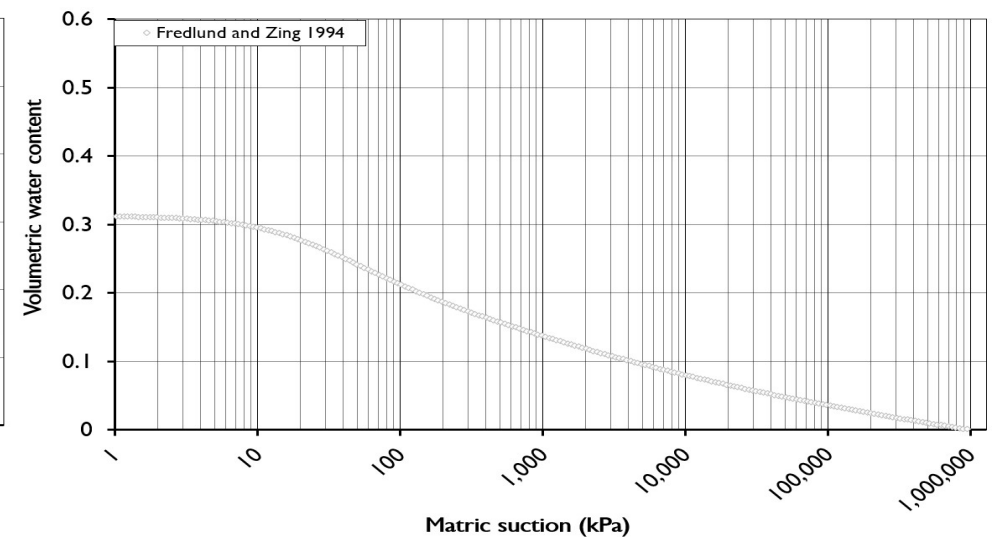
(i)



(j)



(k)



(l)

Figure 12 In-situ SWCCs



## b Saturated hydraulic conductivity

The saturated hydraulic conductivity of the topsoil, ISL, RPL, CB and tailings were derived from the 2018 sampling program carried out by the Mine:

- topsoil — 0.04 m/day or  $4.62 \times 10^{-7}$  m/s;
- ISL — 0.063 m/day or  $7.4 \times 10^{-7}$  m/s;
- RPL — 0.000063 m/day or  $7.4 \times 10^{-10}$  m/s;
- CB — 2 m/day or  $2.31 \times 10^{-5}$  m/s;
- tailings — 0.0001 m/day or  $1 \times 10^{-8}$  m/s.

These values assume that the cover is built perfectly to engineering specifications. Differing saturated hydraulic conductivities were therefore also modelled to represent the possible range of values that may be encountered if the covers were to be built on the TSF.

## c Unsaturated hydraulic conductivity

The model derives unsaturated hydraulic conductivity curves from the SWCCs and the saturated hydraulic conductivity.

### 6.1.4 Analysis method

Rainfall data spanning 128 years from 1889 to 2019 was obtained from the Bureau of Meteorology SILO data drill (<https://www.longpaddock.qld.gov.au/silo/>).

The model was initially run for 25-years. The model was then run for a six month period ie the monitoring period using the artificial rainfall data described in Section 5.1.5.

Finally, the model was run for a dry, average and wet years described in further detail in Section 6.1.4.2.

#### 6.1.4.1 Steady state conditions

The primary model run (25 years) allowed the initial head condition within the model to reach a steady-state.

#### 6.1.4.2 Transient analysis

A series of transient analyses were completed using the steady state conditions as the initial conditions.

Transient analysis was completed for:

- the six months described in Section 5.1.5;
- the average year;
- the wet year; and
- the dry year.

The annual sequence of daily rainfall corresponding to the average, wettest and driest years was selected from the ranked annual rainfalls (from wettest to driest):

- 1896 was chosen for the average year;
- 2009 was chosen for the wet year; and
- 1905 was chosen for the dry year.

The daily mean values for maximum and minimum temperature, maximum and minimum humidity and wind speed were obtained from the SILO data drill and were used for the scenarios.

The annual rainfall for the scenarios are presented in Table 19.

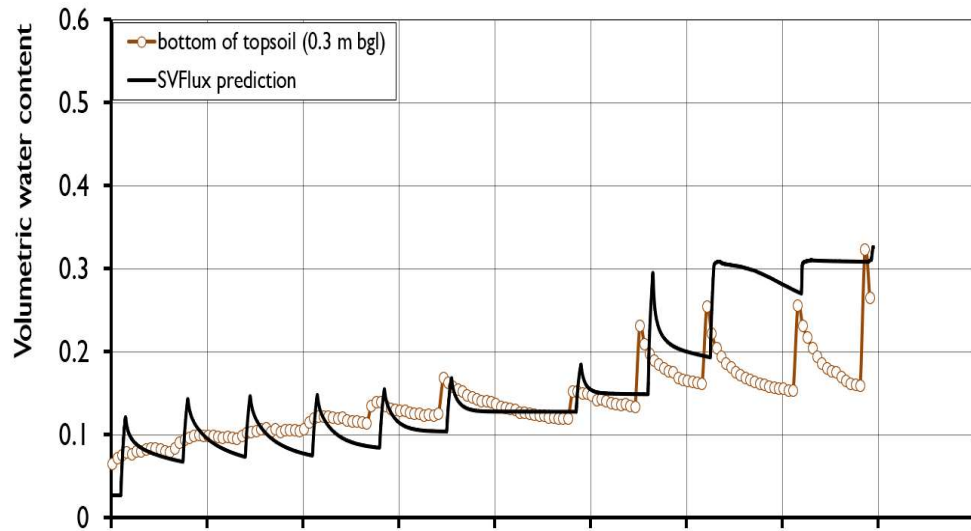
**Table 19 Annual rainfall and evaporation for model scenarios**

<b>Scenarios</b>	<b>Year</b>	<b>Annual rainfall (mm)</b>
Six month period	-	510-910
Average	1896	471
Wet	2009	1391.1
Dry	1905	117.3

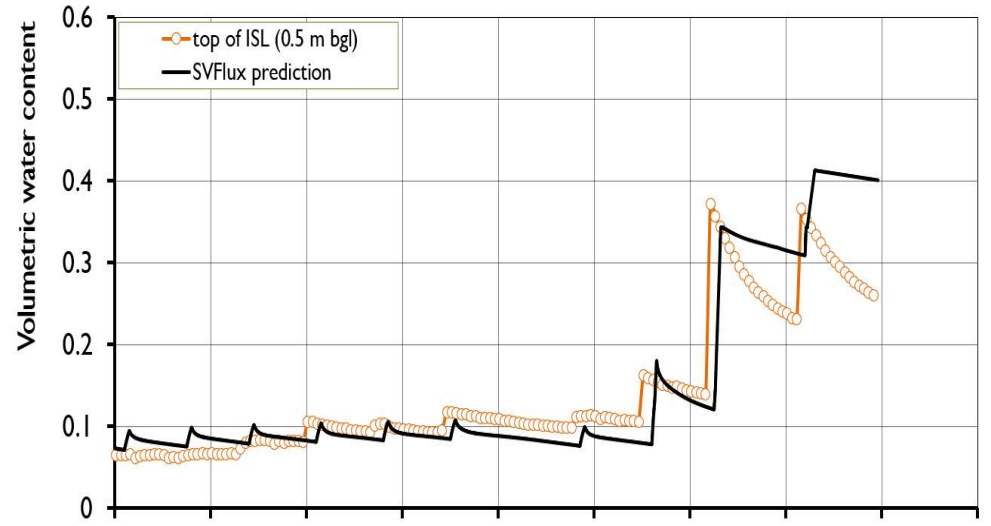
## 6.2 Results

As an example, Figure 13a shows the results of model topsoil VWC prediction compared to the in-situ results for cover option 1. Figure 13b-f shows the results of the model ISL, RPL and CB VWC predictions compared to the in-situ results for cover option 3 respectively. It is noticeable that the model prediction closely matches the magnitude of response measured in the trials. The exception is the RPLs which slowly wet up in the model. In the trials, the RPL stayed relatively dry before quickly wetting up. This indicates that water may be ponding on the RPL surface in the trials whereas the model allows a relatively uniform flow of rainfall through the layer. By the end of the six months, the RPL is saturated in both the model and the trials.

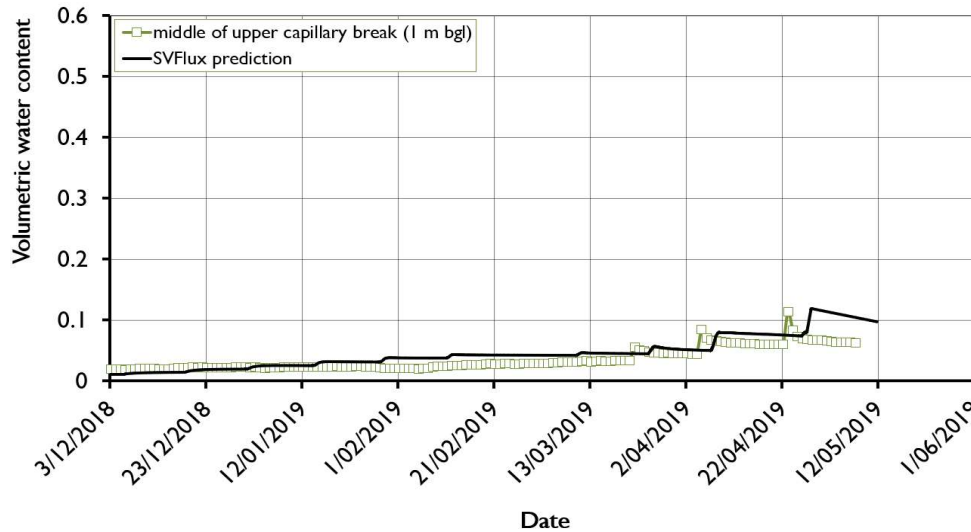
The model has validated the initial conditions described in Section 6.1.3 and provides actual evaporation results using the Modified Wilson Empirical Equation (Wilson et al. 1997) which are presented in Section 6.2.1.



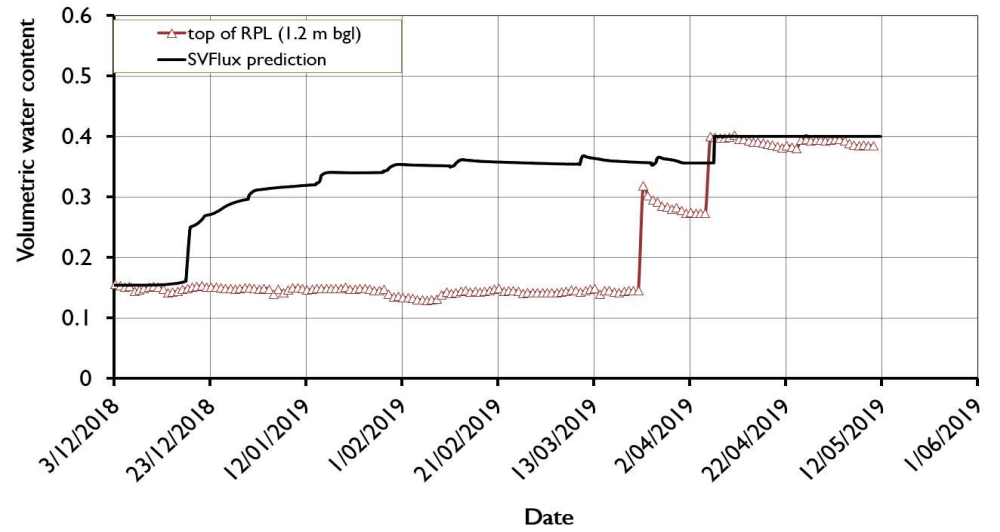
(a)



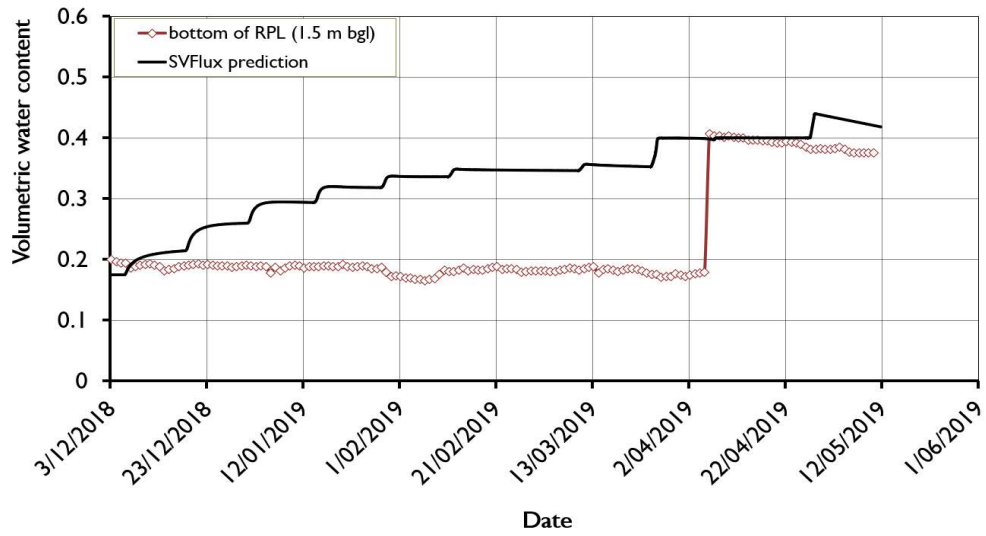
(b)



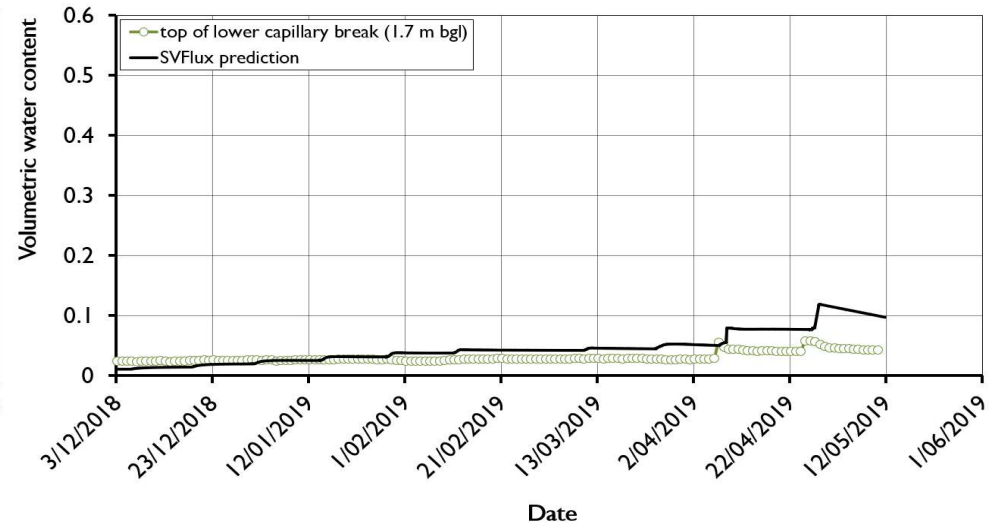
(c)



(d)



(e)



(f)

Figure 13 Model results compared to the trials

## 6.2.1 Water balance

A comparison of the artificial rainfall water balance from the trials to the model is presented in Table 20. A range is given representing the range of saturated hydraulic conductivity values that may be encountered in the covers if they were to be built on the TSF. The comparison shows that whilst the semi-calibrated model shows a high correlation between the predicted and observed stored infiltration, it is less accurate in its prediction of seepage. Modelled seepage was within 4-7% of that observed in the trials which still represents a reasonable degree of accuracy. The exception is cover option 2 (explained below). A comparison is also given where the trials are subject to an equal amount of artificial rainfall (710 mm, which was originally applied to cover option 3).

The inconsistency of the results is likely to do with the SWCCs. That is, the model accuracy would likely improve if the cover was represented by further segregation of the SWCCs presented in Figure 8. Further, the model cannot account for macro-pore infiltration flow in response to short duration, high intensity rainfall which can result in bypass flow through the trials. This is particularly evident in cover option 2 where seepage in the column differs significantly between the trial and the model. Another possibility is that infiltration may have flowed along the edges of the column, resulting in higher seepage being recorded in the rain gauge tipping bucket.

**Table 20 Water balance summary for artificial rainfall**

	Cover option 1		Cover option 2		Cover option 3		Cover option 4	
	Column	Model	Column	Model	Column	Model	Column	Model
Artificial rainfall (mm)	910	910	910	910	710	710	510	510
Stored infiltration (%)	5.9	4.3-5.1	5.4	5.3-5.9	3.1	2.3-2.6	1.9	1.7-3.9
Seepage (%)	14.7	8	26.9	3.4	7.2	12.9-13	0.2	4.6-4.7
Evaporation (%)	79.4	86.9-87.7	67.7	90.7-91.3	89.8	82-82.6	98	91.5-93.7

**Table 21 Water balance summary for 710 mm of artificial rainfall**

	Cover option 1		Cover option 2		Cover option 3		Cover option 4	
	Model		Model		Model		Model	
Artificial rainfall (mm)	710		710		710		710	
Stored infiltration (%)	4.6		4		2.3-2.6		3.3	
Seepage (%)	3.6-3.8		2.6-2.7		12.9-13		12.2	
Evaporation (%)	91.6-91.8		92.5-92.6		82-82.6		84.4	

## 6.2.2 Future cover performance

The performance of cover options 1-4 was assessed for an average, wet and dry year and is presented in Table 22-Table 25 respectively. A range is given representing the range of saturated hydraulic conductivity values that may be encountered in the covers if they were to be built on the TSF. Conservative (ie the worst performing) seepage values have been used across the range of saturated hydraulic conductivity values that were modelled. The maximum seepage which includes an error of 7% (observed in Section 6.2.1) is given in brackets.

**Table 22 Summary of cover option 1 water balance for average, wet and dry years**

	Dry year	Average year	Wet year
Rainfall (mm)	117.3	471	1391.1
Stored infiltration (%)	~0	0.1-0.6	~0-0.3
Seepage (%)	~0 (7)	1.2 (8.2)	0.8 (7.8)
Actual evaporation (%)	96.8-100	98.9-99.8	98.9-100

**Table 23 Summary of cover option 2 water balance for average, wet and dry years**

	Dry year	Average year	Wet year
Rainfall (mm)	117.3	471	1391.1
Stored infiltration (%)	~0	0.1-0.5	0.1-3.1
Seepage (%)	~0 (7)	0.3 (7.3)	0.1 (7.1)
Actual evaporation (%)	100	99.1-99.8	96.7-99.9

**Table 24 Summary of cover option 3 cover water balance for average, wet and dry years**

	Dry year	Average year	Wet year
Rainfall (mm)	117.3	471	1391.1
Stored infiltration (%)	~0	~0-0.4	~0-0.1
Seepage (%)	~0 (7)	1.6 (8.6)	0.3 (7.3)
Actual evaporation (%)	100	98.1-99.7	99.7-100

**Table 25 Summary of cover option 4 water balance for average, wet and dry years**

	Dry year	Average year	Wet year
Rainfall (mm)	117.3	471	1391.1
Stored infiltration (%)	~0	0.1-0.4	~0-0.1
Seepage (%)	~0 (7)	1.3 (8.3)	1.6 (8.6)
Actual evaporation (%)	100	98.4-99.7	98.4-99.8



Comparison of Table 22-Table 25 shows that all cover options would likely limit seepage to less than 10% of cumulative rainfall. Cover option 1 and 2 have lower seepage and a higher stored infiltration than cover options 3 and 4, indicating that a 1 m thick ISL may provide better performance. A thicker ISL will also aid in the establishment of native vegetation and potentially further decrease seepage through transpiration. The lower rate of seepage in cover option 2 when compared to cover option 1 indicates that the CBs will also help to limit the potential for seepage as the air-filled voids of the CB will act as a physical barrier to infiltration.

Table 21 also shows that a 1 m ISL is likely to have improved performance when subject to periods of short duration, heavy rainfall. These conditions can occur during monsoonal storms which occasionally impact the Mine. Under these climatic conditions, cover option 3 and cover option 4 may have an unacceptable rate of seepage (>10%).

Cover option 1 and 2 are therefore the preferred cover options at this stage. This is due to their increased capability to limit rainfall infiltration into the tailings, as compared with cover option 3 and 4. The necessity of an RPL cannot be confirmed or rejected with confidence at this stage. Additional trials will be required to investigate this (see recommendations, Section 7.1). Cover options 1-4 will also need to be re-trialled with NAF waste rock in place of borrow subsoil (in the RPL and ISL), as either of these materials may be used in the final TSF cover (depending on NAF waste rock availability) (see recommendations, Section 7.1).

### 6.2.3 Performance of the cover options compared to industry examples

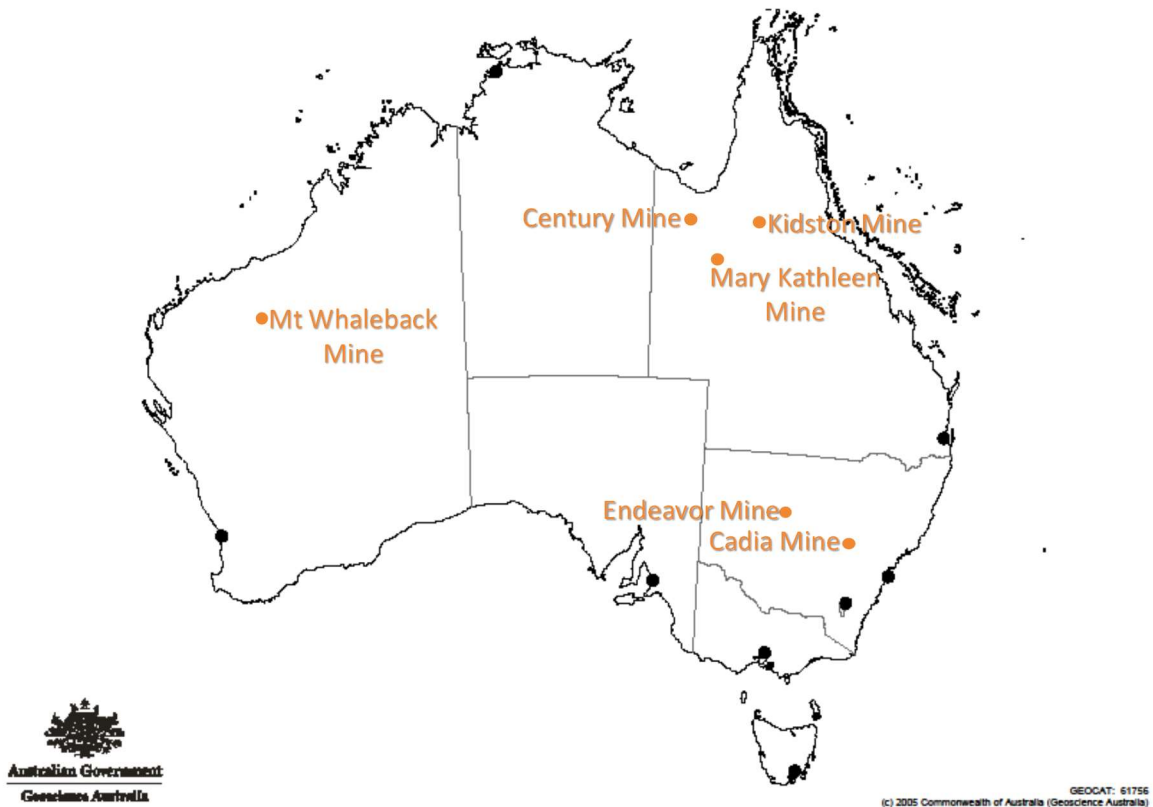
Australian literature that relates to cover geometry is typically for mono (ISL only) or duplex (an ISL underlain by an RPL) layer covers:

- Mt Whaleback Mine and Peak Gold Mine exemplify mono layer covers since the cover is an ISL only (Ayres et al. 2003, O’Kane et al. 2000, O’Kane & Walters 2003) (Figure 14).
- Kidston Mine, Cadia Mine, Century Mine, Endeavor Mine and Mary Kathleen Mine exemplify duplex covers as the covers utilise a RPL overlain by an ISL (Williams et al. 1997; Durham 2002; Wilson 2000, Rohde & Williams 2009, Rohde, Defferrard & Lord 2016; Rohde et al. 2017 & Lottermoser 2003) (Figure 14).

The ratio of evaporation to rainfall (evaporation:rainfall) exceeds two at all of the mines, meaning that store and release covers are appropriate for each mine (Figure 14 and Table 26).

**Table 26 Summary of climate for Australian mines with cover trials**

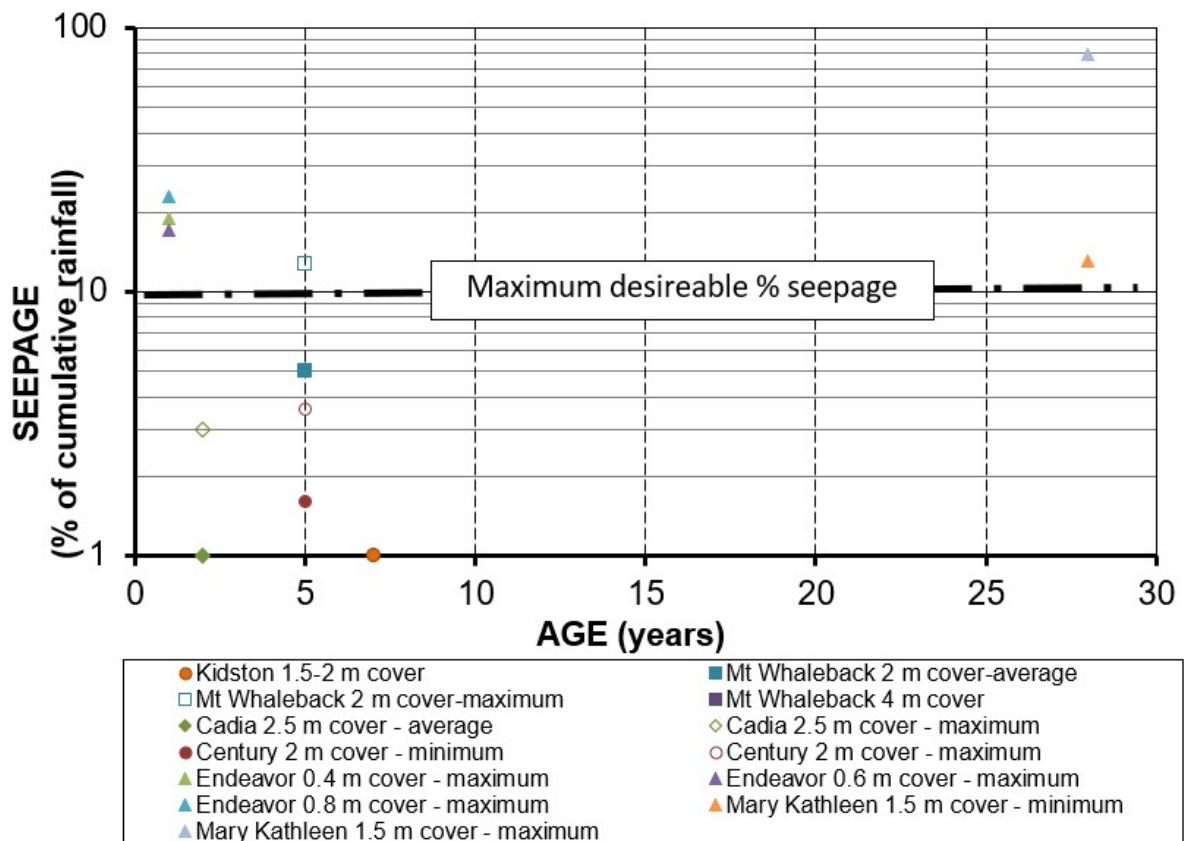
Location	Rainfall (mm)	Evaporation (mm)	Evaporation:Rainfall
Kidston Mine	700	2,800	4
Mt Whaleback Mine	320	3,000	~9
Cadia Mine	900	2,000	~2
Century Mine	544	2,700	~5
Endeavor Mine	400	1,200	3
Mary Kathleen Mine	420	2,800	~6.5



**Figure 14 Location of mines with cover trials**

Cover performance is difficult to determine from the literature with the reviewer often required to make some assumptions to estimate the performance of the cover (where performance relies on the estimation of seepage percentage from the base of the cover). Some examples of seepage that has been reported in the literature include (Figure 15):

- 2 m and 4 m mono layer cover options for Mt Whaleback Mine;
- 1.5-2 m duplex layer cover at Kidston Gold Mine;
- 2m duplex layer cover at Cadia Mine;
- 2 m duplex layer cover at Century Mine;
- 0.4-0.8 m duplex layer covers at Endeavor Mine; and
- 1.5 m duplex layer cover at Mary Kathleen Mine.



**Figure 15 Performance of Australian cover trials**

From Figure 15 it is notable that cover performance monitoring has only been generally reported for short periods of up to 7 years. The performance of the covers, from the estimation of seepage percentage, ranges from near zero for Kidston Mine (duplex layer cover) to nearly 30% for Mt Whaleback Mine (mono layer cover) and Mary Kathleen Mine (duplex layer cover). Century Mine which has the most comparable climate to the Mine (Table 26), has limited seepage to between 1.5-3.6%.

The maximum desirable percentage seepage rate shown in Figure 15 (10%) is approximately equivalent to  $8.6 \times 10^{-4}$  metres per second (m/s), being the approximate natural rate of groundwater recharge in semi-arid Australian climates (Cook et al. 2004).

The review suggests that the preferred covers would perform comparably to those in the literature and below the maximum desirable seepage rate. Option 3 and 4 would likely perform worse than maximum desirable seepage rate during short duration, high intensity rainfall events (eg monsoon conditions). This review also suggests that a 1 m thick ISL is likely required and that the optimum cover thickness for the Mine is likely between 1.2-2.3 m (depending on whether an RPL and/or CBs are included).

## 7.0 Conclusions and recommendations

---

The study has shown through the trials and a semi-calibrated model that the TSF cover will likely require a 1 m thick ISL to reduce the potential for seepage into the potentially contaminating tailings. A reduction of rainfall infiltration will limit the potential for environmental harm through ARD.

An environmental risk assessment was undertaken in conjunction with preliminary, uncalibrated modelling in SVFlux. The purpose of this was to determine the most suitable store and release cover options for the TSF (which would then progress to column trials). The preliminary model showed that cover option 2 was the preferred option. The availability of NAF waste rock for use in the TSF cover is unknown at this stage. Borrow subsoil was identified as a potential alternative material for use in the ISL and RPL. This material was therefore trialled in place of NAF waste rock in the trials.

The column trials were commissioned in December 2018 and were subjected to varying amounts of artificial rainfall (510-910 mm) over a six-month period to slowly saturate the trials and develop a maximum water balance. The total artificial rainfall applied to each cover varied due to the varying thicknesses and materials of the different covers and the subsequent requirements to generate appropriate wetting up and drying out data. The trials have not shown any signs of significant capillary rise. The water balance of the trials was measured by calibrated matric suction sensors and VWC sensors. Seepage from the base of the trials was measured by rain gauge tipping buckets. Seepage results were recorded for the purpose of completing the maximum water balances (Table 18). Seepage results are not indicative of potential future cover performance due to the varying amounts of rainfall applied to each cover option. The semi-calibrated model was used to compare cover performance.

Following the column trials, the maximum water balance was used to develop a semi-calibrated model in SVFlux. The model used SWCCs, saturated hydraulic conductivities and potential evaporation rates derived from the trials. The semi-calibrated model showed a good correlation to the observed results and it was accepted that the semi-calibrated model could be used to predict the long-term performance of the covers within a seepage error range of 4-7%.

Finally, the trials performance was simulated for a wet, average and dry year to predict the likely long-term performance of the four different covers had they been built on the TSF. The model was also run to simulate 710 mm of artificial rainfall applied to the trials (ie the artificial rainfall applied to cover option 3). The long-term prediction showed that a cover containing a 1 m thick ISL provides the best balance between rainfall infiltration storage and seepage. Seepage was predicted to be under 10% of annual rainfall in the long-term. The 710 mm of artificial rainfall model showed that the covers with a 0.5 m ISL are likely to experience high rates of seepage (>10% of annual rainfall) when subjected to short duration, high intensity rainfall (eg monsoonal conditions). This can be attributed to a lower infiltration storage capacity and as well as lower evaporation. A thicker ISL will also aid in the establishment of native vegetation and potentially further decrease seepage through transpiration. Cover option 1 and 2 are therefore the preferred cover options at this stage. Cover option 1 consists of:

- a 0.4 m CB layer of gap-graded NAF waste rock above the tailings at a density of 1.43 t/m<sup>3</sup>;
- a 0.5 m RPL of borrow subsoil above the CB layer at a density of 2.31 t/m<sup>3</sup>;
- a 1 m ISL of borrow subsoil above the RPL at a density of 1.64 t/m<sup>3</sup>; and
- a 0.2 m topsoil layer above the ISL at a density of 1.7 t/m<sup>3</sup>.

Cover option 2 consists of:

- a 0.3 m CB layer of gap-graded NAF waste rock above the tailings at a density of 1.38 t/m<sup>3</sup>;
- a 0.5 m RPL of borrow subsoil above the CB layer at a density of 2.27 t/m<sup>3</sup>;
- a 0.3 m CB layer of gap-graded NAF waste rock above the RPL at a density of 1.38 t/m<sup>3</sup>;
- a 1 m ISL of borrow subsoil above the CB layer at a density of 1.64 t/m<sup>3</sup>; and
- a 0.2 m topsoil layer above the ISL at a density of 1.7 t/m<sup>3</sup>.

The necessity of an RPL cannot be confirmed or rejected with confidence at this stage. Additional trials are required and are discussed in Section 7.1. Cover options 1-4 will also need to be re-trialled with NAF waste rock in place of borrow subsoil (in the RPL and ISL), as either of these materials may be used in the final TSF cover (depending on NAF waste rock availability) (see recommendations, Section 7.1).

A comparison to Australian examples of mine site covers suggests that the preferred covers would perform comparably to those in the literature and below the maximum desirable seepage rate. Option 3 and 4 would likely perform above the maximum desirable seepage rate during short duration, high intensity rainfall events. This review also suggests that a 1 m thick ISL is likely required and that the optimum cover thickness for the Mine is likely between 1.2-2.3 m (depending on whether an RPL and/or CBs are included).

## 7.1 Recommendations

The recommendations made from this study are:

1. The *Conceptual Closure Plan* (MMG 2015) has the following material balance available:
  - 79,751 m<sup>3</sup> of soil (MMG 2015);
  - 25,445 m<sup>3</sup> of soil, rock and vegetation mulch; and
  - 3.5 Mt or 1,750,000 m<sup>3</sup> of NAF waste rock assuming a density of 2 t/m<sup>3</sup>.

A detailed study is required to identify the potential sources and total volumes of potential cover material.

2. As the ISL and RPL in the chosen cover may contain borrow subsoil or NAF waste rock (depending on NAF waste rock availability), it is recommended that cover options 1-4 are trialled with NAF waste rock substituted for borrow subsoil. These covers will then be subjected to an artificial rainfall program. These covers would therefore include:

- Cover option 5:
  - a 0.4 m CB layer of NAF waste rock;
  - a 0.5 m RPL of NAF waste rock above the CB layer;
  - a 1 m ISL of NAF waste rock above the RPL; and
  - a 0.2 m topsoil layer above the ISL.
- Cover option 6:
  - a 0.3 m CB layer of NAF waste rock;
  - a 0.5 m RPL of NAF waste rock above the CB layer;
  - a 0.3 m CB layer of NAF waste rock above the RPL;
  - a 1 m ISL of NAF waste rock above the CB layer; and
  - a 0.2 m topsoil layer above the ISL.
- Cover option 7:
  - a 0.3 m CB layer of NAF waste rock;
  - a 0.5 m RPL of NAF waste rock above the CB layer;
  - a 0.3 m CB layer of NAF waste rock above the RPL;
  - a 0.5 m ISL of NAF waste rock above the CB layer; and
  - a 0.2 m topsoil layer above the ISL.
- Cover option 8:
  - a 0.5 m ISL of NAF waste rock; and
  - a 0.2 m topsoil layer above the ISL.

3. The necessity of an RPL cannot be confirmed or rejected for the covers in this report. Additional trials (following the trials in recommendation 2) are therefore recommended to eliminate this uncertainty. This will involve decommissioning two column trials and constructing the following covers. These trials will then be subjected to an artificial rainfall program.

- Cover option 9:
  - a 0.5 m RPL of borrow subsoil;
  - a 1 m ISL of borrow subsoil above the RPL; and
  - a 0.2 m topsoil layer above the ISL.
- Cover option 10:
  - a 1 m ISL of borrow subsoil; and

- a 0.2 m topsoil layer above the ISL.

These configurations could then be repeated for NAF waste rock in place of borrow subsoil if required.

4. Following the two sets of recommended trials, the covers of interest (based on the column trial results) should be moved to an uncovered position so that they are exposed to naturally occurring rainfall and evaporation. Vegetation should also be established on the trials. This will allow for a more thorough evaluation of the potential for capillary rise and the subsequent requirement for a CB. Periodic sampling of the trials could also be carried out. This will also allow the water balance to be further refined, including the prediction of long-term performance.
5. Once an area of the TSF is available, large field trials should then be established and monitored prior to building the preferred cover on the TSF. The final decision on cover thickness should be based on (field) monitoring data for infiltration and seepage.

# References

---

- AGC Woodward Clyde 1991. Preliminary Waste Characterisation. Report prepared for Minenco Pty Limited.
- Australian Tailings Consultants (ATC) 2008. Dugald River Project Feasibility Study — Tailings Storage Facility — Final Report. Report prepared for MMG.
- ATC Williams 2015. MMG Dugald River - Tailings Storage Facility, Laboratory Testing Report. Report prepared for MMG.
- AustralAsian Resource Consultants (AARC) 2008. Waste Rock Characterisation Report, Dugald River Project. Report prepared for OZ Minerals Australia Limited.
- AustralAsian Resource Consultants (AARC) 2010. Soil and Land Suitability Assessment. Report prepared for MMG.
- Australian Tailings Consultants (ATC) 2008. Dugald River Project Feasibility Study — Tailings Storage Facility — Final Report. Report prepared for MMG.
- Ayres B, Silveria C, Ellice C, Christenson D & O’Kane M 2003. Development of a Cover System Design for Potentially Acid-Forming Tailings at Peak Gold Mine, in in AB Fourie and M Tibbett (eds),. Proceedings of Sixth International Conference on Mine Closure.
- Cedergren, H 1977. Seepage, Drainage, and Flow nets. John Wiley & Sons, New York.
- Charman PEV & Murphy BW 2010. Soils their properties and management. New South Wales Department of Natural Resources.
- Cook PG, Leaney FW & Miles M 2004. Groundwater recharge in the north-east Mallee Region, South Australia’ CSIRO land and water Technical report no. 25/04.
- DERM 1998. Draft Guideline for the Assessment and Management of Contaminated Land in Queensland, Environmental Protection Agency, Brisbane, Queensland.
- Environmental Geochemistry International (EGi) 2009. Geochemistry and column leach testing of tailings. Dugald River Zinc Project, Queensland. Report prepared for Oz Minerals Australia Limited.
- Environmental Geochemistry International (EGi) 2010. Assessment of the Geochemical Characteristics and ARD Potential of Waste Rock for the Dugald River Zinc, Lead & Silver Deposit. Report prepared for MMG.
- Fredlund DG & Rhardjo H 1993. Soil mechanics for unsaturated soils. John Wiley and sons. Canada.
- Fredlund D & Xing A 1994. Equations for the soil-water characteristic curve. Canadian Geotechnical Journal, 31, 521-532.
- Fredlund D, Xing A & Huang A 1994. Predicting the permeability function for unsaturated soils using the soil water characteristic curve. Canadian Geotechnical Journal, 31, 533-546.
- GARD Guide 2009. Global Acid Rock Drainage Guide, viewed at [www.gardguide.com](http://www.gardguide.com).
- Lottermoser BG, Costelloe MT & Ashley PM 2003. Tailings dam seepage at the rehabilitated Mary Kathleen Uranium Mine, Northwest Queensland, Australia. Proceedings of Sixth International Conference on Acid Rock Drainage.
- MMG 2015. Conceptual Closure Plan | Dugald River Mine. Internal report prepared by MMG.

O’Kane M & Walters P 2003. Dry Trial covers at Mt Whaleback - A Summary of Overburden Storage Area Cover System Performance., in AB Fourie and M Tibbett (eds), Proceedings of Sixth International Conference on Mine Closure.

O’Kane M, Porterfield D & Weir A 2000. Cover System Performance in a Semi-Arid Climate on Horizontal and Sloped Waste Rock Surfaces., in unknown (eds), Proceedings of Fifth International Conference on Acid Rock Drainage.

Rawes WJ, Brackensiek DL & Lodsdon SD 1983. Predicting Saturated Hydraulic Conductivity Utilizing Fractal Principles. Soil Science of America Journal, 57.

Rob Lait and Associates 2011. Dugald River Project — Tailings Storage Dam Groundwater Aspects and Conceptual Groundwater Model. Report prepared for MMG.

Rohde TK, Hardie K & Jamson N 2017. Improved Rehabilitation Outcomes through SMART Cover Design at Endeavor Mine, NSW., in Bell, L.C., Edraki, M. and Gerbo C (eds), Proceedings of the Ninth Australian Workshop on Acid and Metalliferous Drainage.

Rohde TK, Williams DJ & Burton J 2011. Store and release cover performance at Cadia Hill gold mine, Australia., in AB Fourie and M Tibbett (eds), Proceedings of Sixth International Conference on Mine Closure.

Rohde TK, Defferrard P & Lord M 2016. Store and release cover water balance for the south waste rock dump at Century mine., in AB Fourie and M Tibbett (eds), Proceedings of the 11th International Conference of Mine Closure.

SoilVision Systems Lts (SoilVision) 2009. SoilVision A Knowledge-Based Database System For Saturated/Unsaturated Soil Properties.

SoilVision Systems Lts (SoilVision) 2018. SVFlux 1D/2D/3D saturated/unsaturated finite element groundwater seepage modelling.

Williams DJ 2008. Field and Laboratory Testing of Trafficed Shale. Report prepared for MMG Century Mine.

Williams DJ & King G 2016. Capping of a surface slurried coal tailings storage facility., in AB Fourie and M Tibbett (eds), Proceedings of the 11th International Conference of Mine Closure.

Williams DJ, Stolberg DJ & Currey NA 2006. Long-term performance of Kidston’s “store/release” cover system over potentially acid forming waste rock dumps., in RI Barnhisel (ed), Proceedings of Seventh International Conference on Acid Rock Drainage.

Williams DJ, Wilson G & Currey N 1997. A cover system for potentially acid forming waste rock dump in a dry climate., in unknown (eds), Proceedings of the Fourth International Conference on Tailings and Mine Waste.





**Appendix A – Stockpiled soil, borrow subsoil  
and tailings chemistry (MMG 2018)**

## CERTIFICATE OF ANALYSIS

**Work Order** : **EB1907024**  
**Client** : **MMG GROUP LTD**  
**Contact** : CARL RIECK  
**Address** : PO BOX 69  
                   CLONCURRENCY QLD, AUSTRALIA 4824  
**Telephone** : ----  
**Project** : DUGALD RIVER  
**Order number** : 4200001897  
**C-O-C number** : ----  
**Sampler** : NICK JAMSON  
**Site** : ----  
**Quote number** : EN/222  
**No. of samples received** : 12  
**No. of samples analysed** : 12

**Page** : 1 of 10  
**Laboratory** : Environmental Division Brisbane  
**Contact** : Customer Services EB  
**Address** : 2 Byth Street Stafford QLD Australia 4053  
**Telephone** : +61-7-3243 7222  
**Date Samples Received** : 19-Mar-2019 09:45  
**Date Analysis Commenced** : 21-Mar-2019  
**Issue Date** : 02-Apr-2019 08:32



Accreditation No. 825  
 Accredited for compliance with  
 ISO/IEC 17025 - Testing

This report supersedes any previous report(s) with this reference. Results apply to the sample(s) as submitted. This document shall not be reproduced, except in full.

This Certificate of Analysis contains the following information:

- General Comments
- Analytical Results

**Additional information pertinent to this report will be found in the following separate attachments: Quality Control Report, QA/QC Compliance Assessment to assist with Quality Review and Sample Receipt Notification.**

### Signatories

This document has been electronically signed by the authorized signatories below. Electronic signing is carried out in compliance with procedures specified in 21 CFR Part 11.

<i>Signatories</i>	<i>Position</i>	<i>Accreditation Category</i>
Ben Felgendrejeris	Senior Acid Sulfate Soil Chemist	Brisbane Acid Sulphate Soils, Stafford, QLD
Kim McCabe	Senior Inorganic Chemist	Brisbane Acid Sulphate Soils, Stafford, QLD
Kim McCabe	Senior Inorganic Chemist	Brisbane Inorganics, Stafford, QLD



## General Comments

The analytical procedures used by the Environmental Division have been developed from established internationally recognized procedures such as those published by the USEPA, APHA, AS and NEPM. In house developed procedures are employed in the absence of documented standards or by client request.

Where moisture determination has been performed, results are reported on a dry weight basis.

Where a reported less than (<) result is higher than the LOR, this may be due to primary sample extract/digestate dilution and/or insufficient sample for analysis.

Where the LOR of a reported result differs from standard LOR, this may be due to high moisture content, insufficient sample (reduced weight employed) or matrix interference.

When sampling time information is not provided by the client, sampling dates are shown without a time component. In these instances, the time component has been assumed by the laboratory for processing purposes.

Where a result is required to meet compliance limits the associated uncertainty must be considered. Refer to the ALS Contact for details.

Key : CAS Number = CAS registry number from database maintained by Chemical Abstracts Services. The Chemical Abstracts Service is a division of the American Chemical Society.  
LOR = Limit of reporting  
^ = This result is computed from individual analyte detections at or above the level of reporting  
∅ = ALS is not NATA accredited for these tests.  
~ = Indicates an estimated value.

- ALS is not NATA accredited for the analysis of Exchangeable Aluminium and Exchange Acidity in soils when performed under ALS Method ED005.
- ALS is not NATA accredited for the analysis of Exchangeable Cations on Alkaline Soils when performed under ALS Method ED006.
- ASS: EA013 (ANC) Fizz Rating: 0- None; 1- Slight; 2- Moderate; 3- Strong; 4- Very Strong; 5- Lime.
- EA058 Emerson: V. = Very, D. = Dark, L. = Light, VD. = Very Dark
- ED007 and ED008: When Exchangeable Al is reported from these methods, it should be noted that Rayment & Lyons (2011) suggests Exchange Acidity by 1M KCl - Method 15G1 (ED005) is a more suitable method for the determination of exchange acidity (H+ + Al3+).



## Analytical Results

Sub-Matrix: DI WATER LEACHATE  
 (Matrix: WATER)

Client sample ID

				CB 1	CB 2	CB 3	Tailing 1	Tailings 2
Client sampling date / time				02-Dec-2018 00:00	02-Dec-2018 00:00	02-Dec-2018 00:00	02-Dec-2018 00:00	02-Dec-2018 00:00
Compound	CAS Number	LOR	Unit	EB1907024-007	EB1907024-008	EB1907024-009	EB1907024-010	EB1907024-011
				Result	Result	Result	Result	Result
<b>EG020W: Water Leachable Metals by ICP-MS</b>								
Aluminium	7429-90-5	0.01	mg/L	0.04	0.04	0.02	0.47	6.36
Antimony	7440-36-0	0.001	mg/L	<0.001	<0.001	<0.001	<0.001	<0.001
Arsenic	7440-38-2	0.001	mg/L	0.004	0.003	0.003	0.005	0.005
Barium	7440-39-3	0.001	mg/L	0.250	0.346	0.845	0.278	0.480
Bismuth	7440-69-9	0.001	mg/L	<0.001	<0.001	<0.001	<0.001	<0.001
Cadmium	7440-43-9	0.0001	mg/L	<0.0001	<0.0001	<0.0001	0.841	1.55
Chromium	7440-47-3	0.001	mg/L	<0.001	<0.001	<0.001	<0.001	<0.001
Cobalt	7440-48-4	0.001	mg/L	<0.001	<0.001	<0.001	0.123	0.193
Copper	7440-50-8	0.001	mg/L	<0.001	0.010	<0.001	0.054	0.178
Lead	7439-92-1	0.001	mg/L	<0.001	<0.001	<0.001	1.82	2.15
Lithium	7439-93-2	0.001	mg/L	0.003	0.004	0.003	0.043	0.078
Manganese	7439-96-5	0.001	mg/L	<0.001	<0.001	<0.001	63.5	61.9
Molybdenum	7439-98-7	0.001	mg/L	0.001	<0.001	<0.001	<0.001	<0.001
Nickel	7440-02-0	0.001	mg/L	<0.001	<0.001	<0.001	0.535	0.681
Selenium	7782-49-2	0.01	mg/L	<0.01	<0.01	<0.01	<0.01	<0.01
Silver	7440-22-4	0.001	mg/L	<0.001	<0.001	<0.001	<0.001	<0.001
Strontium	7440-24-6	0.001	mg/L	0.041	0.032	0.031	0.803	0.439
Thallium	7440-28-0	0.001	mg/L	<0.001	<0.001	<0.001	0.002	<0.001
Thorium	7440-29-1	0.001	mg/L	<0.001	<0.001	<0.001	<0.001	<0.001
Tin	7440-31-5	0.001	mg/L	<0.001	<0.001	<0.001	<0.001	<0.001
Uranium	7440-61-1	0.001	mg/L	<0.001	<0.001	<0.001	0.003	0.051
Vanadium	7440-62-2	0.01	mg/L	<0.01	<0.01	<0.01	<0.01	<0.01
Zinc	7440-66-6	0.005	mg/L	0.035	0.065	0.076	220	593
Boron	7440-42-8	0.05	mg/L	0.19	0.44	0.15	0.12	0.19
Iron	7439-89-6	0.05	mg/L	<0.05	<0.05	<0.05	<0.05	<0.05
<b>EG035W: Water Leachable Mercury by FIMS</b>								
Mercury	7439-97-6	0.0001	mg/L	<0.0001	<0.0001	<0.0001	<0.0001	<0.0001



## Analytical Results

Sub-Matrix: DI WATER LEACHATE  
 (Matrix: WATER)

Client sample ID

				Tailings 3	----	----	----	----
Client sampling date / time				02-Dec-2018 00:00	----	----	----	----
Compound	CAS Number	LOR	Unit	EB1907024-012	-----	-----	-----	-----
				Result	----	----	----	----
<b>EG020W: Water Leachable Metals by ICP-MS</b>								
Aluminium	7429-90-5	0.01	mg/L	10.4	----	----	----	----
Antimony	7440-36-0	0.001	mg/L	<0.001	----	----	----	----
Arsenic	7440-38-2	0.001	mg/L	0.004	----	----	----	----
Barium	7440-39-3	0.001	mg/L	0.251	----	----	----	----
Bismuth	7440-69-9	0.001	mg/L	<0.001	----	----	----	----
Cadmium	7440-43-9	0.0001	mg/L	1.41	----	----	----	----
Chromium	7440-47-3	0.001	mg/L	<0.001	----	----	----	----
Cobalt	7440-48-4	0.001	mg/L	0.156	----	----	----	----
Copper	7440-50-8	0.001	mg/L	0.438	----	----	----	----
Lead	7439-92-1	0.001	mg/L	2.52	----	----	----	----
Lithium	7439-93-2	0.001	mg/L	0.075	----	----	----	----
Manganese	7439-96-5	0.001	mg/L	55.0	----	----	----	----
Molybdenum	7439-98-7	0.001	mg/L	<0.001	----	----	----	----
Nickel	7440-02-0	0.001	mg/L	0.593	----	----	----	----
Selenium	7782-49-2	0.01	mg/L	<0.01	----	----	----	----
Silver	7440-22-4	0.001	mg/L	<0.001	----	----	----	----
Strontium	7440-24-6	0.001	mg/L	0.367	----	----	----	----
Thallium	7440-28-0	0.001	mg/L	<0.001	----	----	----	----
Thorium	7440-29-1	0.001	mg/L	<0.001	----	----	----	----
Tin	7440-31-5	0.001	mg/L	<0.001	----	----	----	----
Uranium	7440-61-1	0.001	mg/L	0.054	----	----	----	----
Vanadium	7440-62-2	0.01	mg/L	<0.01	----	----	----	----
Zinc	7440-66-6	0.005	mg/L	537	----	----	----	----
Boron	7440-42-8	0.05	mg/L	0.17	----	----	----	----
Iron	7439-89-6	0.05	mg/L	0.20	----	----	----	----
<b>EG035W: Water Leachable Mercury by FIMS</b>								
Mercury	7439-97-6	0.0001	mg/L	<0.0001	----	----	----	----





## Analytical Results

Sub-Matrix: SOIL (Matrix: SOIL)				Client sample ID				
Client sampling date / time				Topsoil 1	Topsoil 2	Topsoil 3	ISL 1	ISL 2
Compound				02-Dec-2018 00:00	02-Dec-2018 00:00	02-Dec-2018 00:00	02-Dec-2018 00:00	02-Dec-2018 00:00
CAS Number	LOR	Unit		EB1907024-001	EB1907024-002	EB1907024-003	EB1907024-004	EB1907024-005
				Result	Result	Result	Result	Result
<b>EA002: pH 1:5 (Soils)</b>								
pH Value	----	0.1	pH Unit	8.2	8.2	8.3	8.4	8.5
<b>EA010: Conductivity (1:5)</b>								
Electrical Conductivity @ 25°C	----	1	µS/cm	100	123	91	237	102
<b>EA055: Moisture Content (Dried @ 105-110°C)</b>								
Moisture Content	----	1.0	%	10.7	16.6	12.5	17.6	17.4
<b>EA058: Emerson Aggregate Test</b>								
Color (Munsell)	----	-	-	Dark Reddish Brown (5YR 3/4)	Dark Brown (7.5YR 3/2)	Dark Brown (7.5YR 3/2)	Dark Brown (7.5YR 3/3)	Dark Brown (7.5YR 3/3)
Texture	----	-	-	Sand	Sandy Loam	Clayey Sand	Clayey Sand	Clayey Sand
Emerson Class Number	EC/TC	-	-	8	4	4	4	4
<b>EA150: Particle Sizing</b>								
+75µm	----	1	%	72	46	59	62	59
+150µm	----	1	%	59	38	49	48	46
+300µm	----	1	%	51	33	43	40	39
+425µm	----	1	%	48	32	41	38	38
+600µm	----	1	%	45	31	38	37	36
+1180µm	----	1	%	40	29	35	34	35
+2.36mm	----	1	%	31	26	29	28	32
+4.75mm	----	1	%	17	19	20	18	29
+9.5mm	----	1	%	<1	<1	<1	<1	26
+19.0mm	----	1	%	<1	<1	<1	<1	<1
+37.5mm	----	1	%	<1	<1	<1	<1	<1
+75.0mm	----	1	%	<1	<1	<1	<1	<1
<b>EA150: Soil Classification based on Particle Size</b>								
Clay (<2 µm)	----	1	%	1	20	15	18	18
Silt (2-60 µm)	----	1	%	23	21	23	17	19
Sand (0.06-2.00 mm)	----	1	%	43	32	31	35	30
Gravel (>2mm)	----	1	%	33	27	31	30	33
Cobbles (>6cm)	----	1	%	<1	<1	<1	<1	<1
<b>EA152: Soil Particle Density</b>								
Soil Particle Density (Clay/Silt/Sand)	----	0.01	g/cm3	2.41	2.32	2.37	2.28	2.27
<b>ED006: Exchangeable Cations on Alkaline Soils</b>								
∅ Exchangeable Calcium	----	0.2	meq/100g	7.4	6.8	7.8	8.9	8.5
∅ Exchangeable Magnesium	----	0.2	meq/100g	1.0	0.9	1.0	1.8	1.4



## Analytical Results

Sub-Matrix: SOIL (Matrix: SOIL)				Client sample ID	Topsoil 1	Topoil 2	Topsoil 3	ISL 1	ISL 2
Client sampling date / time					02-Dec-2018 00:00	02-Dec-2018 00:00	02-Dec-2018 00:00	02-Dec-2018 00:00	02-Dec-2018 00:00
Compound	CAS Number	LOR	Unit	EB1907024-001	EB1907024-002	EB1907024-003	EB1907024-004	EB1907024-005	
				Result	Result	Result	Result	Result	
<b>ED006: Exchangeable Cations on Alkaline Soils - Continued</b>									
∅ Exchangeable Potassium	----	0.2	meq/100g	0.3	0.3	0.3	0.4	0.6	
∅ Exchangeable Sodium	----	0.2	meq/100g	<0.2	<0.2	<0.2	<0.2	<0.2	
∅ Cation Exchange Capacity	----	0.2	meq/100g	8.7	8.1	9.2	11.1	10.5	
∅ Exchangeable Sodium Percent	----	0.2	%	<0.2	<0.2	<0.2	<0.2	<0.2	
∅ Calcium/Magnesium Ratio	----	0.2	-	7.6	7.7	7.4	5.0	6.2	
∅ Magnesium/Potassium Ratio	----	0.2	-	3.0	2.6	3.4	4.2	2.2	
<b>ED040S : Soluble Sulfate by ICPAES</b>									
Sulfate as SO4 2-	14808-79-8	10	mg/kg	20	20	20	140	10	
<b>ED045G: Chloride by Discrete Analyser</b>									
Chloride	16887-00-6	10	mg/kg	<10	<10	<10	20	<10	
<b>EK057G: Nitrite as N by Discrete Analyser</b>									
Nitrite as N (Sol.)	14797-65-0	0.1	mg/kg	<0.1	4.6	<0.1	<0.1	<0.1	
<b>EK058G: Nitrate as N by Discrete Analyser</b>									
Nitrate as N (Sol.)	14797-55-8	0.1	mg/kg	7.8	17.7	1.8	79.5	11.1	
<b>EK059G: Nitrite plus Nitrate as N (NOx) by Discrete Analyser</b>									
Nitrite + Nitrate as N (Sol.)	----	0.1	mg/kg	7.8	22.3	1.8	79.5	11.1	
<b>EK061G: Total Kjeldahl Nitrogen By Discrete Analyser</b>									
Total Kjeldahl Nitrogen as N	----	20	mg/kg	460	360	350	670	560	
<b>EK062: Total Nitrogen as N (TKN + NOx)</b>									
^ Total Nitrogen as N	----	20	mg/kg	470	380	350	750	570	
<b>EK080: Bicarbonate Extractable Phosphorus (Colwell)</b>									
Bicarbonate Ext. P (Colwell)	----	5	mg/kg	14	17	15	<5	8	



## Analytical Results

Sub-Matrix: SOIL (Matrix: SOIL)				Client sample ID	ISL 3	CB 1	CB 2	CB 3	Tailing 1
Client sampling date / time				02-Dec-2018 00:00	02-Dec-2018 00:00	02-Dec-2018 00:00	02-Dec-2018 00:00	02-Dec-2018 00:00	02-Dec-2018 00:00
Compound	CAS Number	LOR	Unit	EB1907024-006	EB1907024-007	EB1907024-008	EB1907024-009	EB1907024-010	EB1907024-010
				Result	Result	Result	Result	Result	Result
<b>EA002: pH 1:5 (Soils)</b>									
pH Value	----	0.1	pH Unit	8.6	----	----	----	----	----
<b>EA009: Nett Acid Production Potential</b>									
Net Acid Production Potential	----	0.5	kg H2SO4/t	----	-407	-399	-438	226	226
<b>EA010: Conductivity (1:5)</b>									
Electrical Conductivity @ 25°C	----	1	µS/cm	105	----	----	----	----	----
<b>EA011: Net Acid Generation</b>									
pH (OX)	----	0.1	pH Unit	----	10.9	10.4	10.4	10.4	2.2
NAG (pH 4.5)	----	0.1	kg H2SO4/t	----	<0.1	<0.1	<0.1	<0.1	106
NAG (pH 7.0)	----	0.1	kg H2SO4/t	----	<0.1	<0.1	<0.1	<0.1	140
<b>EA013: Acid Neutralising Capacity</b>									
ANC as H2SO4	----	0.5	kg H2SO4 equiv./t	----	430	429	456	456	16.7
ANC as CaCO3	----	0.1	% CaCO3	----	43.9	43.8	46.6	46.6	1.7
Fizz Rating	----	0	Fizz Unit	----	5	5	5	5	1
<b>EA055: Moisture Content (Dried @ 105-110°C)</b>									
Moisture Content	----	1.0	%	11.9	----	----	----	----	----
<b>EA058: Emerson Aggregate Test</b>									
Color (Munsell)	----	-	-	Dark Brown (7.5YR 3/3)	----	----	----	----	----
Texture	----	-	-	Clayey Sand	----	----	----	----	----
Emerson Class Number	EC/TC	-	-	4	----	----	----	----	----
<b>EA150: Particle Sizing</b>									
+75µm	----	1	%	60	----	----	----	----	----
+150µm	----	1	%	44	----	----	----	----	----
+300µm	----	1	%	34	----	----	----	----	----
+425µm	----	1	%	31	----	----	----	----	----
+600µm	----	1	%	29	----	----	----	----	----
+1180µm	----	1	%	25	----	----	----	----	----
+2.36mm	----	1	%	19	----	----	----	----	----
+4.75mm	----	1	%	8	----	----	----	----	----
+9.5mm	----	1	%	<1	----	----	----	----	----
+19.0mm	----	1	%	<1	----	----	----	----	----
+37.5mm	----	1	%	<1	----	----	----	----	----
+75.0mm	----	1	%	<1	----	----	----	----	----





## Analytical Results

Sub-Matrix: SOIL (Matrix: SOIL)				Client sample ID	ISL 3	CB 1	CB 2	CB 3	Tailing 1
Client sampling date / time				02-Dec-2018 00:00	02-Dec-2018 00:00	02-Dec-2018 00:00	02-Dec-2018 00:00	02-Dec-2018 00:00	02-Dec-2018 00:00
Compound	CAS Number	LOR	Unit	EB1907024-006	EB1907024-007	EB1907024-008	EB1907024-009	EB1907024-010	
				Result	Result	Result	Result	Result	
<b>EA150: Soil Classification based on Particle Size</b>									
Clay (<2 µm)	----	1	%	18	----	----	----	----	----
Silt (2-60 µm)	----	1	%	18	----	----	----	----	----
Sand (0.06-2.00 mm)	----	1	%	43	----	----	----	----	----
Gravel (>2mm)	----	1	%	21	----	----	----	----	----
Cobbles (>6cm)	----	1	%	<1	----	----	----	----	----
<b>EA152: Soil Particle Density</b>									
Soil Particle Density (Clay/Silt/Sand)	----	0.01	g/cm3	2.35	----	----	----	----	----
<b>ED006: Exchangeable Cations on Alkaline Soils</b>									
∅ Exchangeable Calcium	----	0.2	meq/100g	10.4	----	----	----	----	----
∅ Exchangeable Magnesium	----	0.2	meq/100g	1.8	----	----	----	----	----
∅ Exchangeable Potassium	----	0.2	meq/100g	0.4	----	----	----	----	----
∅ Exchangeable Sodium	----	0.2	meq/100g	<0.2	----	----	----	----	----
∅ Cation Exchange Capacity	----	0.2	meq/100g	12.6	----	----	----	----	----
∅ Exchangeable Sodium Percent	----	0.2	%	<0.2	----	----	----	----	----
∅ Calcium/Magnesium Ratio	----	0.2	-	5.7	----	----	----	----	----
∅ Magnesium/Potassium Ratio	----	0.2	-	4.0	----	----	----	----	----
<b>ED040S : Soluble Sulfate by ICPAES</b>									
Sulfate as SO4 2-	14808-79-8	10	mg/kg	20	----	----	----	----	----
<b>ED042T: Total Sulfur by LECO</b>									
Sulfur - Total as S (LECO)	----	0.01	%	----	0.74	0.98	0.57	7.94	
<b>ED045G: Chloride by Discrete Analyser</b>									
Chloride	16887-00-6	10	mg/kg	<10	----	----	----	----	
<b>EK057G: Nitrite as N by Discrete Analyser</b>									
Nitrite as N (Sol.)	14797-65-0	0.1	mg/kg	0.5	----	----	----	----	
<b>EK058G: Nitrate as N by Discrete Analyser</b>									
Nitrate as N (Sol.)	14797-55-8	0.1	mg/kg	14.2	----	----	----	----	
<b>EK059G: Nitrite plus Nitrate as N (NOx) by Discrete Analyser</b>									
Nitrite + Nitrate as N (Sol.)	----	0.1	mg/kg	14.7	----	----	----	----	
<b>EK061G: Total Kjeldahl Nitrogen By Discrete Analyser</b>									
Total Kjeldahl Nitrogen as N	----	20	mg/kg	870	----	----	----	----	
<b>EK062: Total Nitrogen as N (TKN + NOx)</b>									
^ Total Nitrogen as N	----	20	mg/kg	880	----	----	----	----	
<b>EK080: Bicarbonate Extractable Phosphorus (Colwell)</b>									



**Analytical Results**

Sub-Matrix: SOIL (Matrix: SOIL)				Client sample ID	ISL 3	CB 1	CB 2	CB 3	Tailing 1
Client sampling date / time				02-Dec-2018 00:00	02-Dec-2018 00:00	02-Dec-2018 00:00	02-Dec-2018 00:00	02-Dec-2018 00:00	02-Dec-2018 00:00
Compound	CAS Number	LOR	Unit	EB1907024-006	EB1907024-007	EB1907024-008	EB1907024-009	EB1907024-010	EB1907024-010
				Result	Result	Result	Result	Result	Result
<b>EK080: Bicarbonate Extractable Phosphorus (Colwell) - Continued</b>									
Bicarbonate Ext. P (Colwell)	----	5	mg/kg	6	----	----	----	----	----
<b>EN60: Bottle Leaching Procedure</b>									
Final pH	----	0.1	pH Unit	----	6.9	9.2	9.0	9.0	5.4



## Analytical Results

Sub-Matrix: SOIL (Matrix: SOIL)				Client sample ID	Tailings 2	Tailings 3	----	----	----
Client sampling date / time				02-Dec-2018 00:00	02-Dec-2018 00:00	----	----	----	
Compound	CAS Number	LOR	Unit	EB1907024-011	EB1907024-012	-----	-----	-----	
				Result	Result	----	----	----	
<b>EA009: Nett Acid Production Potential</b>									
Net Acid Production Potential	----	0.5	kg H2SO4/t	232	219	----	----	----	
<b>EA011: Net Acid Generation</b>									
pH (OX)	----	0.1	pH Unit	2.1	2.2	----	----	----	
NAG (pH 4.5)	----	0.1	kg H2SO4/t	120	112	----	----	----	
NAG (pH 7.0)	----	0.1	kg H2SO4/t	149	132	----	----	----	
<b>EA013: Acid Neutralising Capacity</b>									
ANC as H2SO4	----	0.5	kg H2SO4 equiv./t	3.6	3.1	----	----	----	
ANC as CaCO3	----	0.1	% CaCO3	0.4	0.3	----	----	----	
Fizz Rating	----	0	Fizz Unit	0	0	----	----	----	
<b>ED042T: Total Sulfur by LECO</b>									
Sulfur - Total as S (LECO)	----	0.01	%	7.69	7.25	----	----	----	
<b>EN60: Bottle Leaching Procedure</b>									
Final pH	----	0.1	pH Unit	4.8	4.4	----	----	----	

# Certificate of Analysis

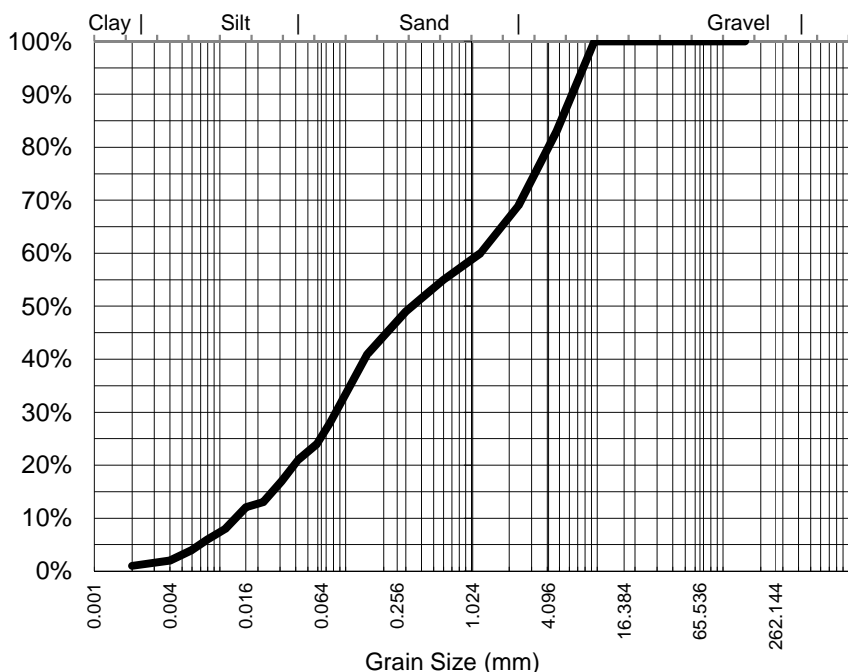
ALS Laboratory Group Pty Ltd  
2 Byth Street, Stafford, QLD 4053  
pH 07 3552 8678  
fax 07 3352 3662  
samples.brisbane@alsenviro.com

**ALS Environmental**  
**Brisbane, QLD**



**CLIENT:** CARL RIECK **DATE REPORTED:** 29-Mar-2019  
**COMPANY:** MMG GROUP LTD **DATE RECEIVED:** 19-Mar-2019  
**ADDRESS:** PO BOX 69 **REPORT NO:** EB1907024-001 / PSD  
CLONCURRY QLD, 4824  
**PROJECT:** Dugald River **SAMPLE ID:** Topsoil 1

## Particle Size Distribution



Particle Size (mm)	Percent Passing
9.50	100%
4.75	83%
2.36	69%
1.18	60%
0.600	55%
0.425	52%
0.300	49%
0.150	41%
0.075	28%
Particle Size (microns)	
75	28%
59	24%
42	21%
22	13%
11	8%
6	4%
2	1%

Median Particle Size (mm)*	0.342
----------------------------	-------

Samples analysed as received.

\* Soil Particle Density results fell outside the scope of AS 1289.3.6.3. Typical sediment SPD values used for calculations and consequently, NATA endorsement does not apply to hydrometer results

Median Particle Size is not covered under the current scope of ALS's NATA accreditation.

## Sample Comments:

**Loss on Pretreatment** NA

## Sample Description:

**Test Method:** AS1289.3.6.3 2003

**Soil Particle Density (<2.36mm)** 2.41 (2.45)\* g/cm3

**NATA Accreditation: 825 Site: Newcastle**  
This document is issued in accordance with NATA's accreditation requirements. Accredited for compliance with ISO/IEC 17025. This document shall not be reproduced, except in full.



**Analysed:** 25-Mar-19

**Limit of Reporting:** 1%

**Dispersion Method** Shaker

**Hydrometer Type** ASTM E100

**Satish Trivedi**  
Soil Chemist  
**Authorised Signatory**

# Certificate of Analysis

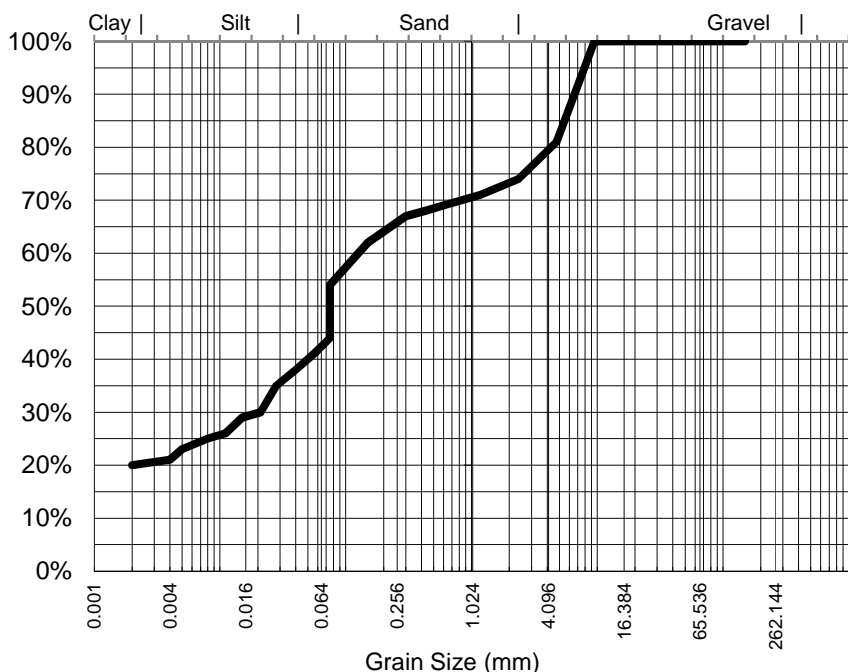
ALS Laboratory Group Pty Ltd  
2 Byth Street, Stafford, QLD 4053  
pH 07 3552 8678  
fax 07 3352 3662  
samples.brisbane@alsenviro.com

**ALS Environmental**  
**Brisbane, QLD**



**CLIENT:** CARL RIECK **DATE REPORTED:** 29-Mar-2019  
**COMPANY:** MMG GROUP LTD **DATE RECEIVED:** 19-Mar-2019  
**ADDRESS:** PO BOX 69 **REPORT NO:** EB1907024-002 / PSD  
CLONCURRY QLD, 4824  
**PROJECT:** Dugald River **SAMPLE ID:** Topoil 2

## Particle Size Distribution



Particle Size (mm)	Percent Passing
9.50	100%
4.75	81%
2.36	74%
1.18	71%
0.600	69%
0.425	68%
0.300	67%
0.150	62%
0.075	54%
Particle Size (microns)	
75	44%
56	41%
40	38%
21	30%
11	26%
5	23%
2	20%

Median Particle Size (mm)*	0.075
----------------------------	-------

Samples analysed as received.

\* Soil Particle Density results fell outside the scope of AS 1289.3.6.3. Typical sediment SPD values used for calculations and consequently, NATA endorsement does not apply to hydrometer results

Median Particle Size is not covered under the current scope of ALS's NATA accreditation.

### Sample Comments:

**Loss on Pretreatment** NA

### Sample Description:

**Test Method:** AS1289.3.6.3 2003

**Soil Particle Density (<2.36mm)** 2.32 (2.45)\* g/cm3

**NATA Accreditation: 825 Site: Newcastle**  
This document is issued in accordance with NATA's accreditation requirements. Accredited for compliance with ISO/IEC 17025. This document shall not be reproduced, except in full.



**Analysed:** 25-Mar-19

**Limit of Reporting:** 1%

**Dispersion Method** Shaker

**Hydrometer Type** ASTM E100

**Satish Trivedi**  
Soil Chemist  
**Authorised Signatory**

# Certificate of Analysis

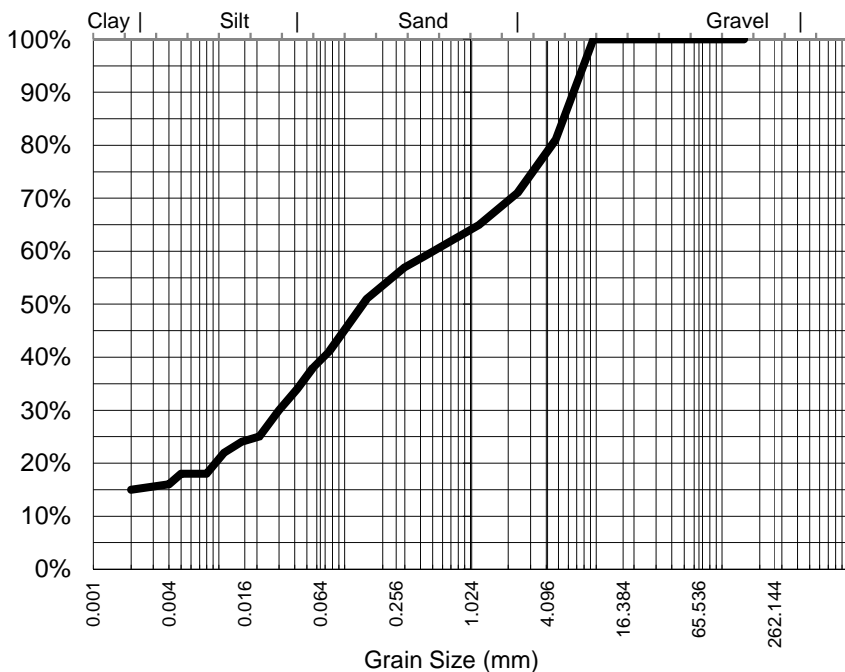
ALS Laboratory Group Pty Ltd  
2 Byth Street, Stafford, QLD 4053  
pH 07 3552 8678  
fax 07 3352 3662  
samples.brisbane@alsenviro.com

**ALS Environmental**  
**Brisbane, QLD**



**CLIENT:** CARL RIECK **DATE REPORTED:** 29-Mar-2019  
**COMPANY:** MMG GROUP LTD **DATE RECEIVED:** 19-Mar-2019  
**ADDRESS:** PO BOX 69 **REPORT NO:** EB1907024-003 / PSD  
CLONCURRY QLD, 4824  
**PROJECT:** Dugald River **SAMPLE ID:** Topsoil 3

## Particle Size Distribution



Particle Size (mm)	Percent Passing
9.50	100%
4.75	81%
2.36	71%
1.18	65%
0.600	61%
0.425	59%
0.300	57%
0.150	51%
0.075	41%
Particle Size (microns)	
75	41%
56	38%
42	34%
21	25%
11	22%
5	18%
2	15%

Median Particle Size (mm)*	0.143
----------------------------	-------

Samples analysed as received.

\* Soil Particle Density results fell outside the scope of AS 1289.3.6.3. Typical sediment SPD values used for calculations and consequently, NATA endorsement does not apply to hydrometer results

Median Particle Size is not covered under the current scope of ALS's NATA accreditation.

## Sample Comments:

**Loss on Pretreatment** NA

## Sample Description:

**Test Method:** AS1289.3.6.3 2003

**Soil Particle Density (<2.36mm)** 2.37 (2.45)\* g/cm3

**NATA Accreditation: 825 Site: Newcastle**  
This document is issued in accordance with NATA's accreditation requirements. Accredited for compliance with ISO/IEC 17025. This document shall not be reproduced, except in full.



**Analysed:** 25-Mar-19

**Limit of Reporting:** 1%

**Dispersion Method** Shaker

**Hydrometer Type** ASTM E100

**Satish Trivedi**  
Soil Chemist  
**Authorised Signatory**

# Certificate of Analysis

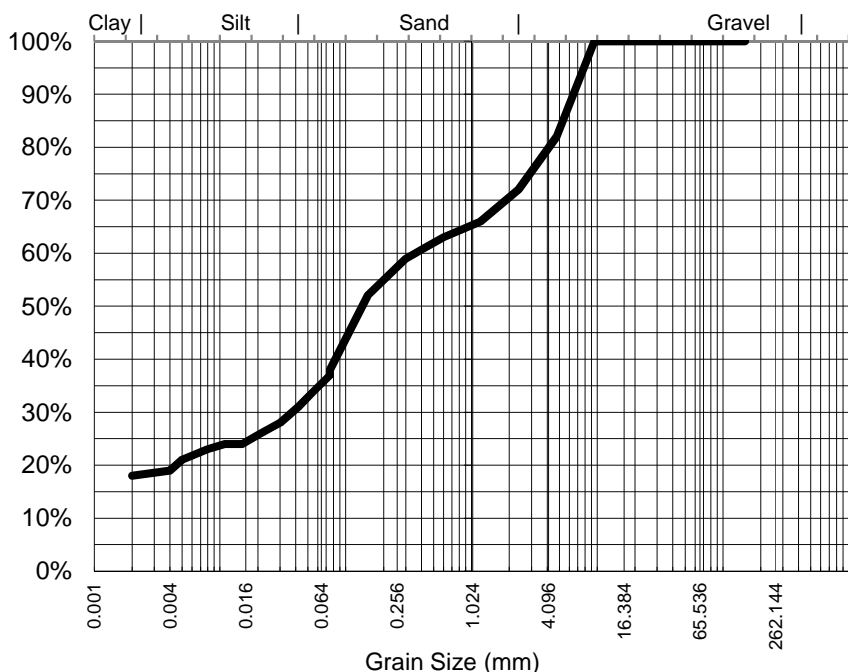
ALS Laboratory Group Pty Ltd  
2 Byth Street, Stafford, QLD 4053  
pH 07 3552 8678  
fax 07 3352 3662  
samples.brisbane@alsenviro.com

**ALS Environmental**  
**Brisbane, QLD**



**CLIENT:** CARL RIECK **DATE REPORTED:** 29-Mar-2019  
**COMPANY:** MMG GROUP LTD **DATE RECEIVED:** 19-Mar-2019  
**ADDRESS:** PO BOX 69 **REPORT NO:** EB1907024-004 / PSD  
CLONCURRY QLD, 4824  
**PROJECT:** Dugald River **SAMPLE ID:** ISL 1

## Particle Size Distribution



Particle Size (mm)	Percent Passing
9.50	100%
4.75	82%
2.36	72%
1.18	66%
0.600	63%
0.425	61%
0.300	59%
0.150	52%
0.075	38%
Particle Size (microns)	
75	37%
56	34%
42	31%
21	26%
11	24%
5	21%
2	18%

Median Particle Size (mm)*	0.139
----------------------------	-------

Samples analysed as received.

\* Soil Particle Density results fell outside the scope of AS 1289.3.6.3. Typical sediment SPD values used for calculations and consequently, NATA endorsement does not apply to hydrometer results

Median Particle Size is not covered under the current scope of ALS's NATA accreditation.

## Sample Comments:

**Loss on Pretreatment** NA

## Sample Description:

**Test Method:** AS1289.3.6.3 2003

**Soil Particle Density (<2.36mm)** 2.28 (2.45)\* g/cm3

**NATA Accreditation: 825 Site: Newcastle**  
This document is issued in accordance with NATA's accreditation requirements. Accredited for compliance with ISO/IEC 17025. This document shall not be reproduced, except in full.



**Analysed:** 25-Mar-19

**Limit of Reporting:** 1%

**Dispersion Method** Shaker

**Hydrometer Type** ASTM E100

**Satish Trivedi**  
Soil Chemist  
**Authorised Signatory**

# Certificate of Analysis

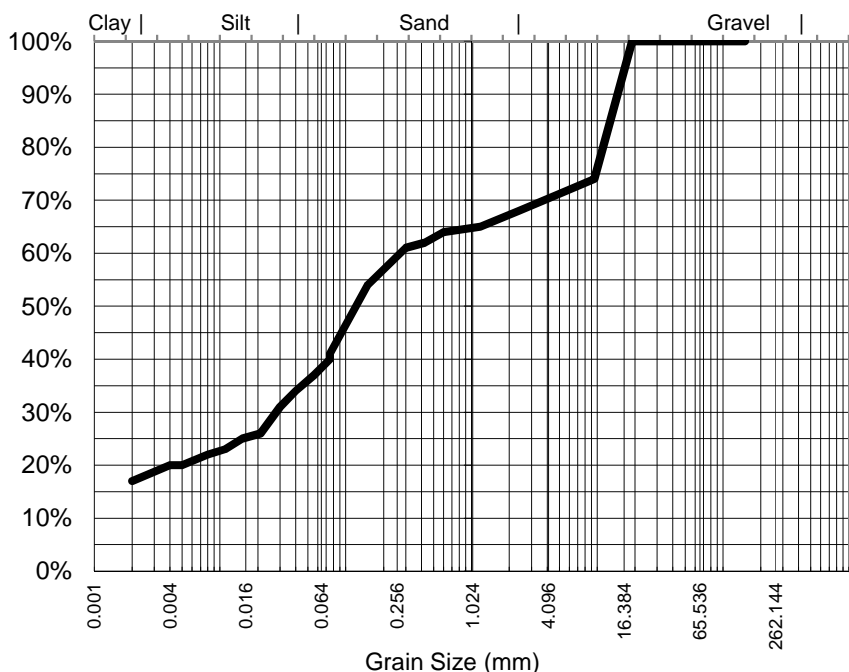
ALS Laboratory Group Pty Ltd  
2 Byth Street, Stafford, QLD 4053  
pH 07 3552 8678  
fax 07 3352 3662  
samples.brisbane@alsenviro.com

**ALS Environmental**  
**Brisbane, QLD**



**CLIENT:** CARL RIECK **DATE REPORTED:** 29-Mar-2019  
**COMPANY:** MMG GROUP LTD **DATE RECEIVED:** 19-Mar-2019  
**ADDRESS:** PO BOX 69 **REPORT NO:** EB1907024-005 / PSD  
CLONCURRY QLD, 4824  
**PROJECT:** Dugald River **SAMPLE ID:** ISL 2

## Particle Size Distribution



Particle Size (mm)	Percent Passing
19.0	100%
9.50	74%
4.75	71%
2.36	68%
1.18	65%
0.600	64%
0.425	62%
0.300	61%
0.150	54%
0.075	41%
Particle Size (microns)	
75	40%
56	37%
40	34%
21	26%
11	23%
5	20%
2	17%

Median Particle Size (mm)*	0.127
----------------------------	-------

Samples analysed as received.

\* Soil Particle Density results fell outside the scope of AS 1289.3.6.3. Typical sediment SPD values used for calculations and consequently, NATA endorsement does not apply to hydrometer results

Median Particle Size is not covered under the current scope of ALS's NATA accreditation.

## Sample Comments:

**Loss on Pretreatment** NA

## Sample Description:

**Test Method:** AS1289.3.6.3 2003

**Soil Particle Density (<2.36mm)** 2.27 (2.45)\* g/cm3

**NATA Accreditation: 825 Site: Newcastle**  
This document is issued in accordance with NATA's accreditation requirements. Accredited for compliance with ISO/IEC 17025. This document shall not be reproduced, except in full.



**Analysed:** 25-Mar-19

**Limit of Reporting:** 1%

**Dispersion Method** Shaker

**Hydrometer Type** ASTM E100

**Satish Trivedi**  
Soil Chemist  
**Authorised Signatory**



# Certificate of Analysis

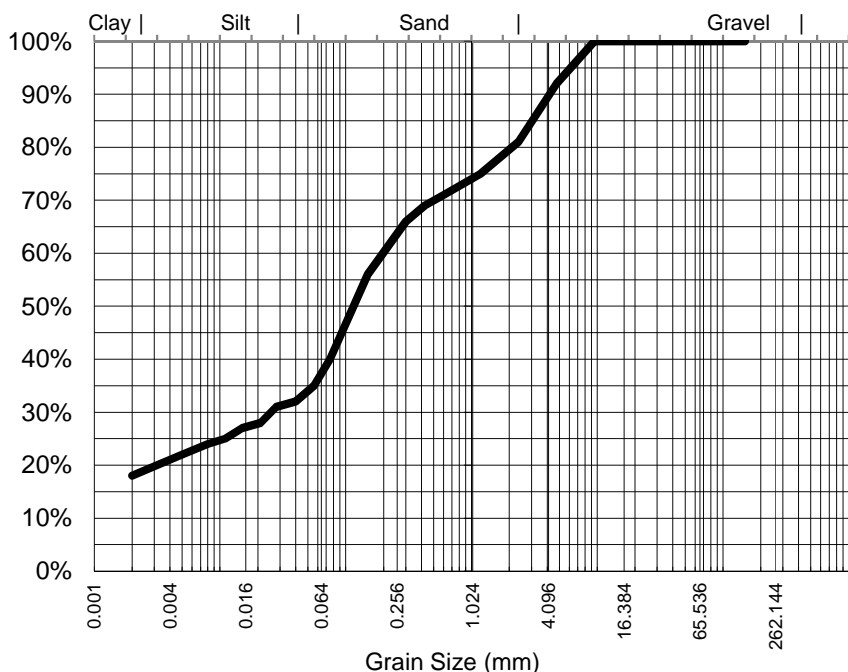
ALS Laboratory Group Pty Ltd  
2 Byth Street, Stafford, QLD 4053  
pH 07 3552 8678  
fax 07 3352 3662  
samples.brisbane@alsenviro.com

**ALS Environmental**  
**Brisbane, QLD**



**CLIENT:** CARL RIECK **DATE REPORTED:** 29-Mar-2019  
**COMPANY:** MMG GROUP LTD **DATE RECEIVED:** 19-Mar-2019  
**ADDRESS:** PO BOX 69 **REPORT NO:** EB1907024-006 / PSD  
CLONCURRENCY QLD, 4824  
**PROJECT:** Dugald River **SAMPLE ID:** ISL 3

## Particle Size Distribution



Particle Size (mm)	Percent Passing
9.50	100%
4.75	92%
2.36	81%
1.18	75%
0.600	71%
0.425	69%
0.300	66%
0.150	56%
0.075	40%
Particle Size (microns)	
75	40%
56	35%
40	32%
21	28%
11	25%
5	22%
2	18%

Median Particle Size (mm)*	0.122
----------------------------	-------

Samples analysed as received.

\* Soil Particle Density results fell outside the scope of AS 1289.3.6.3. Typical sediment SPD values used for calculations and consequently, NATA endorsement does not apply to hydrometer results

Median Particle Size is not covered under the current scope of ALS's NATA accreditation.

### Sample Comments:

**Loss on Pretreatment** NA

### Sample Description:

**Test Method:** AS1289.3.6.3 2003

**Soil Particle Density (<2.36mm)** 2.35 (2.45)\* g/cm3

**NATA Accreditation: 825 Site: Newcastle**  
This document is issued in accordance with NATA's accreditation requirements. Accredited for compliance with ISO/IEC 17025. This document shall not be reproduced, except in full.



**Analysed:** 25-Mar-19

**Limit of Reporting:** 1%

**Dispersion Method** Shaker

**Hydrometer Type** ASTM E100

*Satish Trivedi*

**Satish Trivedi**  
Soil Chemist  
**Authorised Signatory**



Appendix B – Borrow subsoil and tailings physical characterisation (MMG 2018)



# Permeability - Constant Head Method

TEST IN ACCORDANCE WITH IN-HOUSE PROCEDURE 7.1.1

SAMPLE PREPARATION IN ACCORDANCE WITH

AS 1289.5.1.1       CONSOLIDATED



Client: MMG Dugald River ..... NATA Report No.: R10219 .....  
 Address: Dugald River Mine, PO Box 69, ..... Job No.: 108003.39 .....  
 Cloncurry QLD 4824.....  
 Project: Dugald River - Soils and Tailings Testing ..... Location: QLD.....

Sample Register No.	03019		
Sample Description	Soils Sample Screened on 19mm sieve Size		

### Sample as Prepared

Dry Density @ 95% Compaction (t/m <sup>3</sup> )	1.93		
Moisture Content (%)	10.0		
Bulk Density (wet) (t/m <sup>3</sup> )	2.12		

### Test Conditions

Surcharge (kPa)	18.0		
Sample Height (mm)	60.0		
Test Dry Density (t/m <sup>3</sup> )	1.91		
Water Used	Melbourne Tap Water		
Conductivity of Water (µS/cm)	60		
Hydraulic Gradient	29.7		

### Test Results

Permeability @ 20°C (m/s)	7.4 x 10 <sup>-10</sup>		
Final Moisture Content (%)	12.6		

#### Test Notes:

- Sampled by ATC Williams Pty Ltd in accordance with AS 1289.1.2.1
- Sample provided by the client

The test results relate only to the items tested.



NATA ACCREDITED LABORATORY NUMBER: 3372

Accredited for compliance with ISO/IEC 17025 - Testing

Approved Signatory ..... *John Walker* .....

Name of Signatory John Walker

Date Tested: 6 to 12/03/2019

Date Reported: 20/03/2019



ATC Williams Pty Ltd  
 Laboratory  
 19 Beach Avenue, Mordialloc Vic 3915  
 T +61 3 9590 9222 F +61 3 9590 9228  
 melb@atcwilliams.com.au www.atcwilliams.com.au ABN 64 005 931 288

# Particle Size Distribution Results

TEST IN ACCORDANCE WITH AS 1289

- Method 3.6.1
- Method 3.6.3
- Oven Drying Method 2.1.1



**Client:** MMG Dugald River  
**Address:** Dugald River Mine, PO Box 69,  
 Cloncurry QLD 4824  
**Project:** Dugald River - Soils and Tailings Testing

**NATA Report No.:** R09819  
**Job No.:** 108003.39  
**Register No.:** 03019  
**Location:** QLD

Sample Description: Soil Sample	Borehole <input type="checkbox"/> No:	Test Pit <input type="checkbox"/> Depth:
---------------------------------	--	---

Dispersion Method used: Mechanical Stirrer for 1 minute

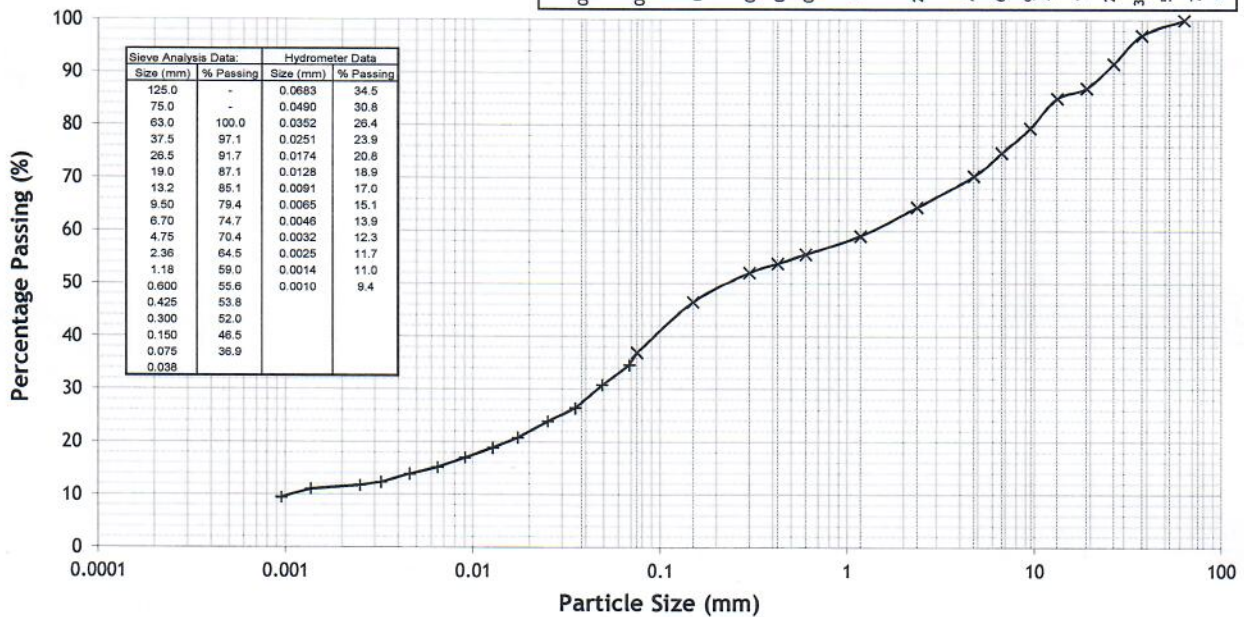
Hydrometer Type Used: ASTM 152H

- Sampled by ATC Williams Pty Ltd in accordance with AS 1289.1.2.1 Clause 6.5.4
- Sample provided by the Client

Note 1: The sample was oven-dried during sample preparation and not air-dried as stated in AS 1289.3.6.3

Note 2: The sample was mixed with a propeller type stirrer rather than inverting the cylinder as described in AS 1289.3.6.3.  
 The test result relates only to the item tested

0.038	0.075	0.150	0.300	0.425	0.600	1.18	2.36	4.75	6.70	9.50	13.2	19.0	26.5	37.5	53.0	75.0	100
-------	-------	-------	-------	-------	-------	------	------	------	------	------	------	------	------	------	------	------	-----



CLAY	SILT			SAND			GRAVEL			COBBLES
	Fine	Medium	Coarse	Fine	Medium	Coarse	Fine	Medium	Coarse	
	0.002	0.006	0.02	0.06	0.2	0.6	2	6	20	60

NATA ACCREDITED LABORATORY NUMBER: 3372



Accredited for compliance with ISO/IEC 17025 - Testing

Approved Signatory:

*John Walker*  
 Name of Signatory: John Walker

Date Tested: 4 to 7/03/2019

Date Reported: 20/03/2019



ATC Williams Pty Ltd  
 Laboratory  
 19 Beach Avenue, Mordialloc Vic 3915  
 T +61 3 9590 9222 F +61 3 9590 9228  
 melb@atcwilliams.com.au www.atcwilliams.com.au ABN 64 005 931 288

Form RSN 004.16 (PSD)  
 Date of Issue: August 2018



# Soil Dry Density/Moisture Content Relation

TEST IN ACCORDANCE WITH AS 1289

- Method 5.1.1 (STANDARD)
  - Method 5.2.1 (MODIFIED)
- Moisture Content in accordance with AS 1289.2.1.1



Client: MMG Dugald River

NATA Report No.: R10119

Address: Dugald River Mine, PO Box 69,  
Cloncurry QLD 4824

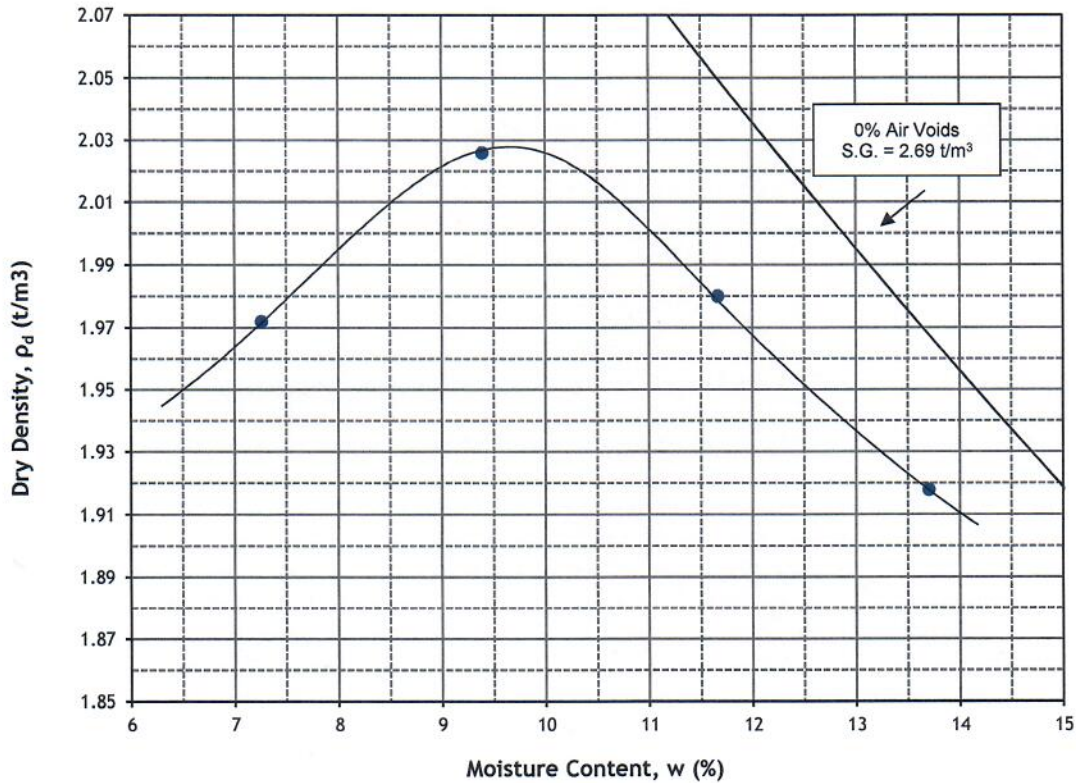
Job No.: 108003.39  
Register No.: 03019

Project: Dugald River - Soils and Tailings Testing

Location: QLD

Sample Description: Soils Sample - Screened on 19mm sieve for determination of Standard MDD/OMC for laboratory permeability testing	Borehole/Pit No:	<input type="checkbox"/>	Compaction Mould - A
			Screened Sample

- Sampled by ATC Williams Pty Ltd in accordance with AS 1289.1.2.1 Clause 6.5.4
- Sample provided by the Client



Maximum Dry Density = 2.03 t/m<sup>3</sup>

Optimum Moisture Content = 9.5 %



NATA ACCREDITED LABORATORY NUMBER: 3372

Accredited for compliance with ISO/IEC 17025 - Testing

Approved Signatory: *John Walker*

Date Tested: 1 to 6/03/2019

Name of Signatory: John Walker

Date Reported: 20/03/2019



ATC Williams Pty Ltd  
Laboratory

19 Beach Avenue, Mordialloc Vic 3915

T +61 3 9590 9222 F +61 3 9590 9228

melb@atcwilliams.com.au www.atcwilliams.com.au ABN 64 005 931 288

Form RSN 007.10 (Comp)

Date of Issue: August 2018

# Determination of the Soil Particle Density of a Soil




TEST IN ACCORDANCE WITH AS 1289.3.5.1

Client: MMG Dugald River ..... NATA Report No.: R09619 .....  
 Address: Dugald River Mine, PO Box 69, ..... Job No.: 108003.39 .....  
 Cloncurry QLD 4824.....  
 Project: Dugald River - Soils and Tailings Testing ..... Location: QLD.....

Register Number	Sample Description	Test Temperature (°C)	% of Sample >2.36 mm	Particle Density (g/cm <sup>3</sup> )
03019	Soils Sample - Passing 2.36mm Sieve Size	23.5	None	2.70 *
03019	Soils Sample - Retained 2.36mm Sieve Size	26.5	100	2.69 x
03019	Soils Sample - Full Grading	-	35.5	2.69 #

Notes:  Sampled by ATC Williams Pty Ltd in accordance with AS 1289.1.2.1  
 Sample provided by the client  
 \* = apparent average soil particle density - particle size less than 2.36 mm  
 X = apparent average soil particle density - particle size greater than 2.36 mm  
 # = soil particle density of the total sample  
 The test results relate only to the items tested.

 NATA ACCREDITED LABORATORY NUMBER: 3372  
 Accredited for compliance with ISO/IEC 17025 - Testing  
 Approved Signatory ..... *John Walker* ..... Date Tested: 4 to 6/03/2019  
 Name of Signatory John Walker Date Reported: 20/03/2019

 ATC Williams Pty Ltd  
 19 Beach Avenue, Mordialloc Vic 3915  
 T +61 3 9590 9222 F +61 3 9590 9228  
 melb@atcwilliams.com.au www.atcwilliams.com.au ABN 64 005 931 288



# Permeability - Constant Head Method

TEST IN ACCORDANCE WITH IN-HOUSE PROCEDURE 7.1.1

SAMPLE PREPARATION IN ACCORDANCE WITH

AS 1289.5.1.1       CONSOLIDATED



**Client:** MMG Dugald River ..... **NATA Report No.:** R10319 .....

**Address:** Dugald River Mine, PO Box 69, ..... **Job No.:** 108003.39 .....

Cloncurry QLD 4824.....

**Project:** Dugald River - Soils and Tailings Testing ..... **Location:** QLD.....

Sample Register No.	03119		
Sample Description	Tailings Sample		

### Sample as Prepared

Dry Density @ 95% Compaction (t/m <sup>3</sup> )	1.60		
Moisture Content (%)	18.8		
Bulk Density (wet) (t/m <sup>3</sup> )	1.90		

### Test Conditions

Surcharge (kPa)	21.6		
Sample Height (mm)	60.0		
Test Dry Density (t/m <sup>3</sup> )	1.58		
Water Used	Melbourne Tap Water		
Conductivity of Water (µS/cm)	60		
Hydraulic Gradient	19.5		

### Test Results

Permeability @ 20°C (m/s)	4.1 x 10 <sup>-08</sup>		
Final Moisture Content (%)	27.8		

#### Test Notes:

- Sampled by ATC Williams Pty Ltd in accordance with AS 1289.1.2.1
- Sample provided by the client

The test results relate only to the items tested.

<p>ACCREDITED FOR TECHNICAL COMPETENCE</p>	NATA ACCREDITED LABORATORY NUMBER: 3372	
	Accredited for compliance with ISO/IEC 17025 - Testing	
	Approved Signatory .....	Date Tested: 6 to 8/03/2019
	Name of Signatory John Walker	Date Reported: 20/03/2019

**ATC Williams Pty Ltd Laboratory**  
 19 Beach Avenue, Mordialloc Vic 3915  
 T +61 3 9590 9222 F +61 3 9590 9228  
 melb@atcwilliams.com.au www.atcwilliams.com.au ABN 64 005 931 288

# Particle Size Distribution Results

TEST IN ACCORDANCE WITH AS 1289

- Method 3.6.1
- Method 3.6.3
- Oven Drying Method 2.1.1



**Client:** MMG Dugald River  
**Address:** Dugald River Mine, PO Box 69,  
 Cloncurry QLD 4824  
**Project:** Dugald River - Soils and Tailings Testing

**NATA Report No.:** R09919  
**Job No.:** 108003.39  
**Register No.:** 03119  
**Location:** QLD

Sample Description: Tailings Samples	Borehole <input type="checkbox"/>	Test Pit <input type="checkbox"/>
	No:	Depth:

Dispersion Method used: Mechanical Stirrer for 1 minute

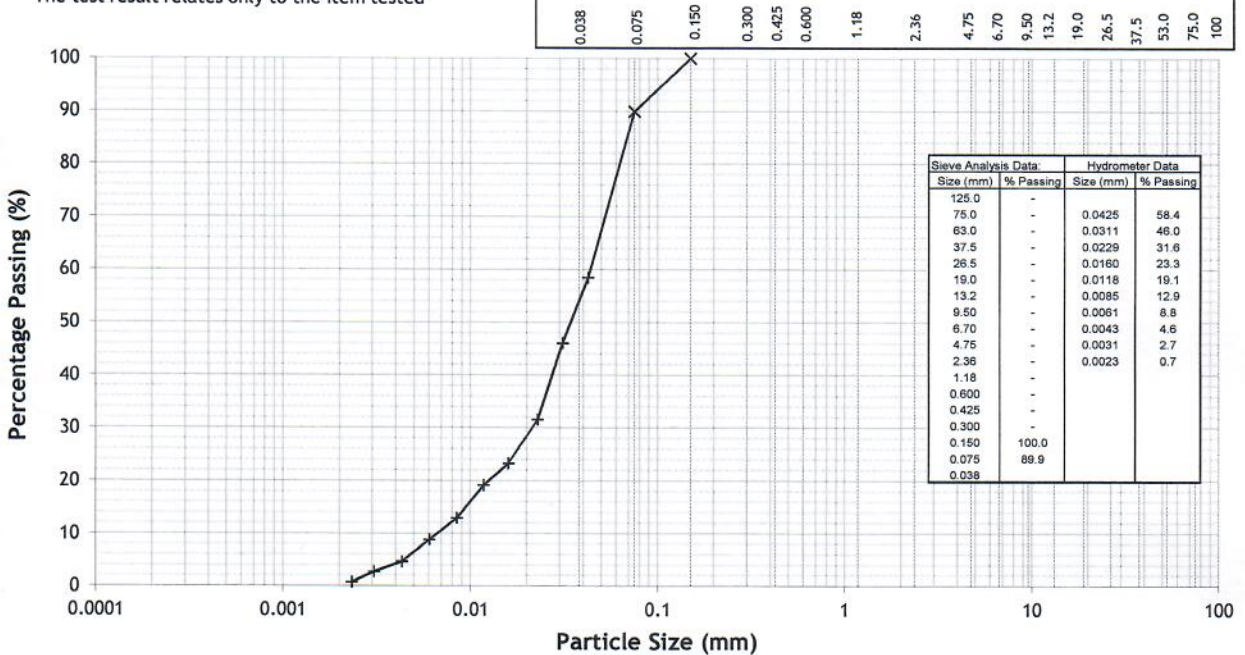
Hydrometer Type Used: ASTM 152H

- Sampled by ATC Williams Pty Ltd in accordance with AS 1289.1.2.1 Clause 6.5.4
- Sample provided by the Client

Note 1: The sample was oven-dried during sample preparation and not air-dried as stated in AS 1289.3.6.3

Note 2: The sample was mixed with a propeller type stirrer rather than inverting the cylinder as described in AS 1289.3.6.3.  
 The test result relates only to the item tested

Australian Standard Sieve Apertures (mm)



CLAY	SILT			SAND			GRAVEL			COBBLES
	Fine	Medium	Coarse	Fine	Medium	Coarse	Fine	Medium	Coarse	
	0.002	0.006	0.02	0.06	0.2	0.6	2	6	20	60

NATA ACCREDITED LABORATORY NUMBER: 3372



Accredited for compliance with ISO/IEC 17025 - Testing

Approved Signatory: *John Walker*  
 Name of Signatory: John Walker

Date Tested: 12 to 14/03/2019

Date Reported: 20/03/2019



ATC Williams Pty Ltd  
 Laboratory  
 19 Beach Avenue, Mordialloc Vic 3915  
 T +61 3 9590 9222 F +61 3 9590 9228

melb@atcwilliams.com.au www.atcwilliams.com.au ABN 64 005 931 288

Form RSN 004.16 (PSD)  
 Date of Issue: August 2018



# Soil Dry Density/Moisture Content Relation

TEST IN ACCORDANCE WITH AS 1289

- Method 5.1.1 (STANDARD)
  - Method 5.2.1 (MODIFIED)
- Moisture Content in accordance with AS 1289.2.1.1



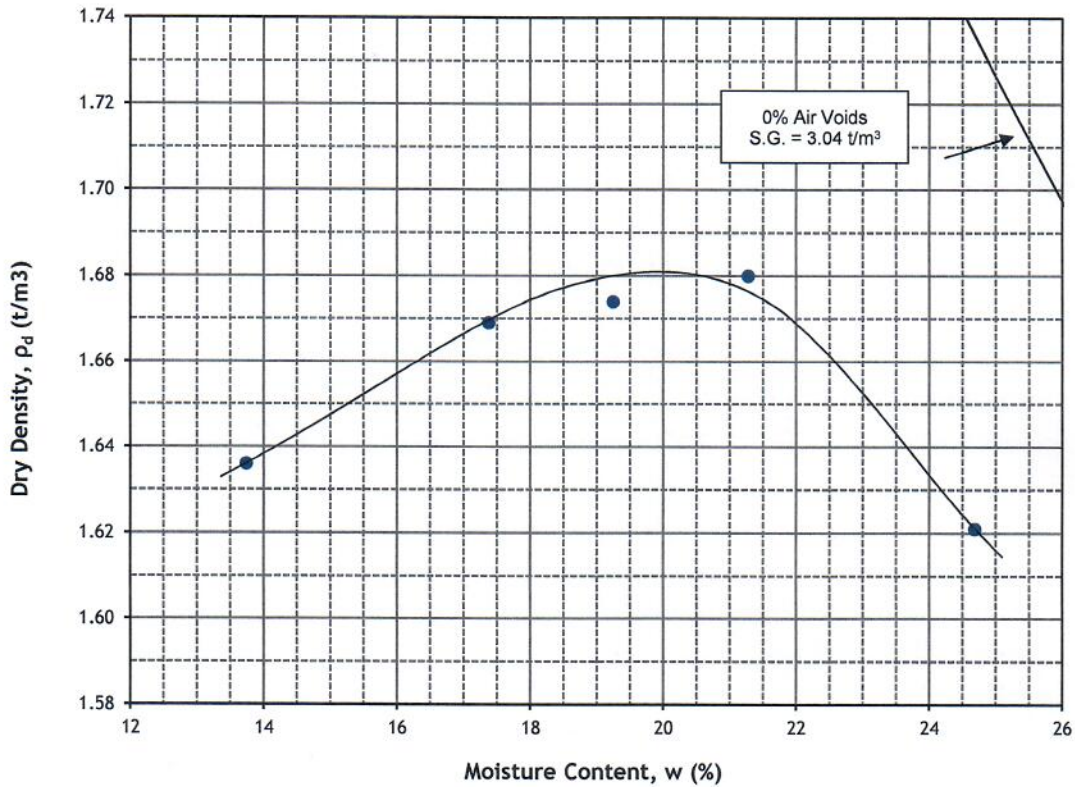
Client: MMG Dugald River NATA Report No.: R10019

Address: Dugald River Mine, PO Box 69, Job No.: 108003.39  
Cloncurry QLD 4824 Register No.: 03119

Project: Dugald River - Soils and Tailings Testing Location: QLD

Sample Description: Tailings Sample Borehole  Test Pit   
 No: \_\_\_\_\_ Depth: \_\_\_\_\_

- Sampled by ATC Williams Pty Ltd in accordance with AS 1289.1.2.1 Clause 6.5.4
- Sample provided by the Client



Maximum Dry Density = 1.68 t/m<sup>3</sup>      Optimum Moisture Content = 20.0 %



NATA ACCREDITED LABORATORY NUMBER: 3372

Accredited for compliance with ISO/IEC 17025 - Testing

Approved Signatory: \_\_\_\_\_

Date Tested: 4 to 6/03/2019

Name of Signatory: John Walker

Date Reported: 20/03/2019



ATC Williams Pty Ltd  
 Laboratory  
 19 Beach Avenue, Mordialloc Vic 3915  
 T +61 3 9590 9222 F +61 3 9590 9228  
 melb@atcwilliams.com.au www.atcwilliams.com.au ABN 64 005 931 288

Form RSN 007.10 (Comp)  
 Date of Issue: August 2018

# Determination of the Soil Particle Density of a Soil




TEST IN ACCORDANCE WITH AS 1289.3.5.1

Client: MMG Dugald River ..... NATA Report No.: R09719 .....  
 Address: Dugald River Mine, PO Box 69, ..... Job No.: 108003.39 .....  
 Cloncurry QLD 4824.....  
 Project: Dugald River - Soils and Tailings Testing ..... Location: QLD.....

Register Number	Sample Description	Test Temperature (°C)	% of Sample >2.36 mm	Particle Density (g/cm <sup>3</sup> )
03119	Tailings Sample - Full Grading	22.9	None	3.04 #

Notes:  Sampled by ATC Williams Pty Ltd in accordance with AS 1289.1.2.1  
 Sample provided by the client  
 \* = apparent average soil particle density - particle size less than 2.36 mm  
 X = apparent average soil particle density - particle size greater than 2.36 mm  
 # = soil particle density of the total sample  
 The test results relate only to the items tested.

 NATA ACCREDITED LABORATORY NUMBER: 3372  
 Accredited for compliance with ISO/IEC 17025 - Testing  
 Approved Signatory ..... Date Tested: 4 to 6/03/2019  
 Name of Signatory John Walker Date Reported: 20/03/2019

 ATC Williams Pty Ltd  
 19 Beach Avenue, Mordialloc Vic 3915  
 T +61 3 9590 9222 F +61 3 9590 9228  
 melb@atcwilliams.com.au www.atcwilliams.com.au ABN 64 005 931 288



# Classification (Atterberg Limits)



TEST IN ACCORDANCE WITH AS 1289 - CONE PENETROMETER

Client: MMG Dugald River ..... NATA Report No.: R09519 .....  
 Address: Dugald River Mine, PO Box 69, ..... Job No.: 108003.39 .....  
 Cloncurry QLD 4824.....  
 Project: Dugald River - Soils and Tailings Testing ..... Location: QLD.....

Register Number	Sample Description	Liquid Limit (%)	Plastic Limit (%)	Plasticity Index (%)	Linear Shrinkage (%)	Soil Classification Group Symbol
03019	Soils Sample	26	17	9	-	CL
03119	Tailings Sample	29	21	8	-	CL

Sampled by ATC Williams Pty Ltd in accordance with AS 1289.1.2.1

Sample provided by the client

The test results relate only to the items tested.

**Test Methods:**

- Liquid Limit AS 1289.3.9.1 (Standard - Penetrometer Method)
- Liquid Limit AS 1289.3.9.2 (One Point - Penetrometer Method)
- Plastic Limit AS 1289.3.2.1
- Plasticity Index AS 1289.3.3.2 (Cone Plasticity Index)
- Linear Shrinkage AS 1289.3.4.1
- Moisture Content AS 1289.2.1.1

**Sample Preparation:**

- Natural Moisture     Air Dried     Oven Dried     Unknown
- Wet Sieved     Dry Sieved     Unsieved



NATA ACCREDITED LABORATORY NUMBER: 3372

Accredited for compliance with ISO/IEC 17025 Testing

Approved Signatory ..... *John Walker* .....

Date Tested: 27 Feb to 5 March 2019

Name of Signatory: John Walker

Date Reported: 19/03/2019



ATC Williams Pty Ltd

19 Beach Avenue, Mordialloc Vic 3915  
 T +61 3 9590 9222 F +61 3 9590 9228

melb@atcwilliams.com.au www.atcwilliams.com.au ABN 64 005 931 288


# Moisture Content of a Soil

TEST IN ACCORDANCE WITH AS 1289.2.1.1

Client: MMG Dugald River ..... NATA Report No.: R09419 .....  
 Address: Dugald River Mine, PO Box 69, ..... Job No.: 108003.39 .....  
 Cloncurry QLD 4824.....  
 Project: Dugald River - Soils and Tailings Testing ..... Location: QLD.....

Register Number	Sample Description	Condition	Moisture Content (%)
03019	Soils Sample	As Received	2.1
03119	Tailings Sample	As Received	7.3

Notes:  
 Sampled by ATC Williams Pty Ltd in accordance with AS 1289.1.2.1  
 Sample provided by the client  
 The test results relate only to the items tested.

 **NATA ACCREDITED LABORATORY NUMBER: 3372**  
 Accredited for compliance with ISO/IEC 17025 - Testing  
 Approved Signatory ..... Date Tested: 27/02/2019  
 Name of Signatory John Walker Date Reported: 19/03/2019

 **ATC Williams Pty Ltd**  
 19 Beach Avenue, Mordialloc Vic 3915  
 T +61 3 9590 9222 F +61 3 9590 9228  
 melb@atcwilliams.com.au www.atcwilliams.com.au ABN 64 005 931 288





Appendix C – MMG risk evaluator matrix



## RISK MANAGEMENT

### APPENDIX A: RISK RATING TABLES

#### A.1 CONTROL EFFECTIVENESS

Each Critical Control must be assessed against its Critical Control Design to determine effectiveness using the Table below. The Control Self-Assessment considers adequacy of Control Design standards, data from Control Execution and Control verification activities and control failures.

Control Self-Assessment Rating	Control Effectiveness Guide
<b>Effective</b>	Control Design requirements are being met and have been assessed as adequate, effectively operated and require no further improvement. There has been no evidence of control failure.
<b>Partially Effective</b>	Control Design requirements are largely being met however there have been instances of isolated control failure and/or areas for improvement have been identified.
<b>Not Effective</b>	There are systemic issues with the Control Design requirements and/or repeatable execution of the control. Improvements are required to enable the control to operate in a consistent, sustainable way.

#### A.2 OVERALL RISK EVALUATION (RISK CONTROL EFFECTIVENESS)

Each Material Risk must be evaluated to determine the overall effectiveness of the control environment. The Overall Risk Evaluation (Risk Control Effectiveness) must consider the Control Self-Assessment ratings of each of the Critical Controls, control failures, significant incidents, near misses, Internal Audit findings and other applicable learnings from across the organization or external industry experience.

Overall Risk Control Effectiveness Rating	Control Effectiveness Guide
<b>Fully effective</b>	Nothing more to be done except review and monitor the existing controls. Controls are well designed for the risk, address the root causes and Management believes that they are effective and reliable at all times.
<b>Substantially effective</b>	Most controls are designed correctly and are in place and effective. Some more work to be done to improve operating effectiveness or Management has doubts about operational effectiveness and reliability.
<b>Partially effective</b>	While the design of controls may be largely correct in that they treat most of the root causes of the risk, they are not consistently executed. or Some of the controls do not seem correctly designed in that they do not treat root causes, those that are correctly designed are operating effectively.
<b>Largely ineffective</b>	Significant control gaps. Either controls do not treat root causes or they do not operate at all effectively.
<b>None or totally ineffective</b>	Virtually no credible control. Management has no confidence that any degree of control is being achieved due to poor control design and/or very limited operational effectiveness.



# RISK MANAGEMENT

## A.3 LIKELIHOOD CRITERIA

Use this table to determine the likelihood of the event occurring resulting in the severity which is being used in the calculation of Risk Level taking into account current preventative controls and their effectiveness.

Likelihood	Business	Projects	Likelihood Category
	Based on MMG and industry experience and expected conditions, the risk event	Based on MMG and industry experience and expected conditions, with similar studies or projects, the risk event	
<b>Almost Certain</b>	Could be incurred more than once in a year	Could be expected to occur more than once during the study or project delivery	<b>F</b>
<b>Likely</b>	Could be incurred over a 1-2 year period	Could easily be incurred and has generally occurred in similar studies or projects	<b>E</b>
<b>Possible</b>	Could be incurred within a 5 year period	Has been incurred in a minority of similar studies or projects	<b>D</b>
<b>Unlikely</b>	Could be incurred within a 5-20 year period	Has been known to happen, but only rarely	<b>C</b>
<b>Rare</b>	Could be incurred within a 20-50 year period	Has not occurred in similar studies or projects but could	<b>B</b>
<b>Very Rare</b>	Could be incurred in a period > 50 years	Conceivable, but only in extreme circumstances	<b>A</b>

## A.4 RISK LEVEL

<b>Likelihood Rating</b>	<b>F</b>	Medium	Medium	High	Very High	Very High	Very High
	<b>E</b>	Low	Medium	High	High	Very High	Very High
	<b>D</b>	Low	Medium	Medium	High	High	Very High
	<b>C</b>	Low	Low	Medium	Medium	High	High
	<b>B</b>	Low	Low	Low	Medium	Medium	High
	<b>A</b>	Low	Low	Low	Low	Medium	Medium
		<b>1</b>	<b>2</b>	<b>3</b>	<b>4</b>	<b>5</b>	<b>6</b>
<b>Consequence Rating</b>							

# RISK MANAGEMENT



## A.5 CONSEQUENCE CRITERIA

**Maximum Foreseeable Loss (MFL)** is the total plausible maximum impact on MMG considering the consequences that could arise if all existing controls were ineffective or missing.

**Consequence level** rating should be chosen on the basis of the expected or most likely impact on MMG taking into account current mitigating controls and their effectiveness.

Rating	Direct and/or Consequential Financial Loss (USD millions)	Planned production throughput (Days)	Fraud or theft (USD millions)	Safety and People	Environment	Legal Compliance
6	>100	>28	>10	<ul style="list-style-type: none"> <li>&gt;2 Fatalities</li> <li>International NGO or National Government intervention in response to multiple community fatalities resulting from mining related activities or disputes</li> </ul>	<ul style="list-style-type: none"> <li>Regional, offsite environmental impact requiring long-term recovery (years) with irreversible residual damage</li> <li>Species extinction or permanent impairment of ecosystem function or biodiversity value within site</li> <li>Irreversible loss/damage to site or item of significant cultural heritage value</li> </ul>	<ul style="list-style-type: none"> <li>Regulatory or operating licence non-compliance, or any incident or circumstance with a probable fine of &gt; USD 30 million</li> <li>Civil claim with damages of &gt;100million</li> <li>Imprisonment of company executive</li> <li>Failure to deliver on community agreements or accords with maximum potential compensation cost of &gt; USD 30 million</li> </ul>
5	>50 – 100	>14 - 28	>5 - 10	<ul style="list-style-type: none"> <li>1 – 2 Fatalities</li> <li>1 or more Community Fatalities resulting from mining related activities or disputes</li> </ul>	<ul style="list-style-type: none"> <li>Prolonged or severe, offsite environmental impact requiring long-term clean-up (years).</li> <li>Extensive unconfined, on lease impact requiring long-term clean-up (months-years) leaving residual damage</li> <li>Change to ecosystem function or biodiversity value within site</li> <li>Irreversible damage to site or item of significant cultural heritage value</li> </ul>	<ul style="list-style-type: none"> <li>Regulatory or operating licence non-compliance, or any incident or circumstance with a probable fine of USD 15 - 30million or potential trigger for loss of licence.</li> <li>Civil claim with damages of more than USD 50 -100 million</li> <li>Failure to deliver on community agreements or accords with maximum potential compensation cost of USD 15-30 million</li> </ul>
4	>10 – 50	>7 - 14	>3 – 5	<ul style="list-style-type: none"> <li>Permanent disabling injury or illness</li> <li>Multiple Lost Time Injuries</li> <li>Multiple Community Medical Treatment Injuries resulting from mining related activities or disputes</li> </ul>	<ul style="list-style-type: none"> <li>Major, offsite, environmental impact requiring medium-term clean-up (months).</li> <li>Onsite confined impact requiring significant clean-up effort (years)</li> <li>Temporary impairment of an ecosystem function or any kill/loss of a listed or protected species</li> <li>Repairable damage to site or item of significant cultural heritage value</li> </ul>	<ul style="list-style-type: none"> <li>Regulatory or operating licence non-compliance with a maximum potential fine of USD 10-&lt;15 million</li> <li>Failure to deliver on community agreements or accords with maximum potential compensation cost of USD 10-&lt;15 million</li> </ul>
3	>5 – 10	>3 - 7	>1 – 3	<ul style="list-style-type: none"> <li>Single Lost Time Injury / Illness</li> <li>Reversible disability / disabling illness(es)</li> <li>Single Community Medical Treatment Injury resulting from mining related activities or disputes</li> </ul>	<ul style="list-style-type: none"> <li>Reversible offsite environmental impact, requiring short-term clean-up (weeks)</li> <li>Onsite, confined, reversible environmental impact, requiring medium term (weeks-months) clean-up</li> </ul>	<ul style="list-style-type: none"> <li>Regulatory or operating licence non-compliance with a maximum potential fine of USD 5 - &lt;10 million</li> <li>Failure to deliver on community agreements or accords with maximum potential compensation cost of USD 5-&lt;10 million</li> </ul>
2	1-5	1 - 3	0.5 - 1	<ul style="list-style-type: none"> <li>Medical Treatment Injury / Illness(es)</li> <li>Restricted Work Injury(ies)</li> </ul>	<ul style="list-style-type: none"> <li>Low, confined, reversible environmental impact</li> <li>Short term (less than a week) clean-up</li> </ul>	<ul style="list-style-type: none"> <li>Regulatory or operating licence non-compliance with a maximum potential fine of less than USD 5 million</li> <li>Failure to deliver on community agreements or accords with maximum potential compensation cost of &lt; USD 5 million</li> </ul>
1	<1	<1	< 0.5	<ul style="list-style-type: none"> <li>First aid treatment</li> </ul>	<ul style="list-style-type: none"> <li>Very low, reversible environmental impact confined to a small area within operations</li> <li>Prompt (within a shift) clean-up</li> </ul>	<ul style="list-style-type: none"> <li>Breach of site standard or direction.</li> <li>Breach of community agreement or accord</li> </ul>

1. "Significant incidents" are shaded.



The image shows four identical grey metal test rigs arranged in a row. Each rig consists of a vertical column with a horizontal base and a top section. The rigs are numbered 1, 2, 3, and 4 from left to right. A white electrical control cabinet is mounted on the second rig. Numerous black cables are connected to the rigs and are bundled on the floor. The background is a white corrugated metal wall.

## Appendix D – Preliminary modelling method and rationale

# Appendix D

## Preliminary modelling method and rationale

### D.1 Capillary break design

The primary cover, reported in the Mine *Environmental Impact Statement*, is a 1.9 m thick store and release cover and is depicted in Figure 7.

#### D.1.1 CB

The primary cover includes a CB, for the purpose of preventing/limiting the potential for capillary rise of constituents into the cover from the underlying tailings. The performance of the CB requires solute transport modelling, which has not been included in this assessment. However, for the CB to function properly it will need to remain unsaturated. Therefore, it must be placed above the tailings and below the RPL to prevent/limit infiltration entering the layer. Further, it must be sufficiently thick so that tailings do not 'bleed' through the layer during placement and it must also be designed so that fines from the ISL and RPL above do not migrate into the layer over time. Infiltration and/or fines migration have the potential to fill the CB pores over time which will provide a pathway for constituents to move from the tailings into the cover.

##### *Thickness*

Capillary rise in a continuous pore is related to its diameter ie the smaller the pore diameter the higher the capillary rise potential. Fredlund and Rahardjo (1993) have described the capillary rise potential as being approximately equal to one-tenth of matric suction. There are a number of factors that will impact on the capillary rise potential including pore distribution, pore shape and continuity. For a pore to reach its maximum capillary rise potential the pore would need to have a continuous meniscus. A continuous meniscus will only exist at matric suctions between the air-entry value (AEV) and water-entry value (WEV) (refer to Appendix H for notes on how to interpret a SWCC).

Using a pedotransfer function (Fredlund and Xing 1994), we can estimate the AEV is ~2 kilopascals (kPa) and the WEV is ~6 kPa resulting in a capillary rise potential of 0.2-0.6 m

##### *Management of fines*

In order to limit the potential for internal migration of fines, the CB will need to be designed as a rock filter following the criteria set by Bertram (1940) and the US Army Corp of Engineers (1977). Both methods for filter design are reported in Cedergren (1977).

Generally, the CB will need to be constructed as two layers ie a 0.3 m gap graded gravel underlain by 0.3 m clean filter sand. It should be noted that the filter design criteria must be applied to the layers of the CB and to the final layer of the CB and the overlying ISL.

### D.2 Cover options analysis

The purpose of this section is to present a semi-quantified options assessment for alternative covers for the rehabilitation of the TSF.

The alternative cover analysis is presented in Table 27. The alternative covers analysis was carried out to identify the potential advantages and disadvantages or risks associated with each alternative cover. The options have been ranked based on the following criteria:

- vegetation establishment;
- PAWC;
- infiltration potential;
- root penetration depth;
- water storage potential;
- capillary rise potential; and
- cost.

a                      Result

The semi-quantified options assessment presented in Table 27 shows that Option B, A, E ranked highest of the options:

- Option B — the Primary Cover with a two-layer CB based on the review presented in Section D.I.I.
- Option A — the Primary Cover.
- Option E — Option B with only half of the ISL thickness.

**Table 27 Alternative covers options analysis**

Option		Cover option 1	Cover option 2	(C)	(D)	Cover option 3	(F)	(G)	(H)	Cover option 4	(J)
Description		Primary Cover	Cover option 1 + two-layer CB	Century Mine cover	Half (A)	Half cover option 2	Half (C)	(B) - RPL	Half (A/B) - RPL	Half (A/B) - RPL - CB	(C) - RPL - CB
Layer	Unit										
Topsoil	m	0.20, 50% cover	0.20, 50% cover	-	0.20, 50% cover	0.20, 50% cover	-	0.20, 50% cover	0.20, 50% cover	0.20, 50% cover	-
ISL	m	1.00	1.00	1.50-2.00	0.50	0.50	0.75	1.00	0.50	0.50	1.50-2.00
RPL	m	0.50	0.50	0.25	0.50	0.50	0.25	0.00	0.00	0.00	0.00
CB	m	0.40	0.60	-	0.40	0.60	-	0.60	0.60	0.00	0.00
Total	m	1.90-2.10	2.10-2.30	1.75-2.25	1.40-1.60	1.60-1.80	1.00	1.60-1.80	1.10-1.30	0.70	1.50-2.00
Advantages		-	Improved CB performance.	Proven. Increased PAWC.	Low cost.	Low cost. Improved CB performance.	Low cost.	Improved CB performance. Low cost.	Improved CB performance. Low cost.	Lowest cost.	Low cost. Increased PAWC.
Disadvantages		High cost. CB performance may be compromised.	High cost.	No vegetation establishment medium (soil). Potential desiccation cracking of RPL.	Decreased PAWC. Decreased infiltration storage. CB performance may be compromised.	Decreased PAWC. Decreased infiltration storage.	No vegetation establishment medium (soil). Decreased PAWC. Decreased infiltration storage. Potential desiccation cracking of RPL. No restriction to capillary rise	No restriction to seepage.	Decreased PAWC. Decreased infiltration storage. No restriction to seepage.	No vegetation establishment medium (soil). Decreased PAWC. Decreased infiltration storage. No restriction to seepage. No restriction to capillary rise	No vegetation establishment medium (soil). No restriction to seepage. No restriction to capillary rise.
<b>Ranking criteria</b>											
PAWC		2	2	1	4	4	3	2	4	4	1
Vegetation establishment		1	1	4	1	1	4	1	1	4	4
Infiltration potential		1	1	2	1	1	2	4	4	4	4
Root penetration depth		2	2	1	4	4	3	2	4	4	1
Water storage potential		1	3	2	5	4	8	4	7	9	6
Capillary rise potential		2	1	4	2	1	4	1	1	4	4
Cost		9	7	8	5	6	2	6	3	1	4
Ranking points		16	15	21	18	17	23	18	20	26	23
Overall ranking		2	1	6	4	3	7	4	5	8	7

## D.3 Method

### D.3.1 Model set-up

The model was developed in one dimension and calculates the upward and downward movement of rainfall infiltration/seepage in the cover; it assumes no surface run off or run on and allows ponding at the surface of the cover.

The model was run for the Primary Cover, Option B, Option E and Option I from Table 27 to allow a comparison of the Primary Cover to:

- a cover option that has a CB designed as a two-layer rock filter;
- a cover option that has only half the thickness of the ISL;
- a cover option that has only half the thickness of the ISL and no RPL or CB.

The purpose of the modelling exercise is to arrive at an assessment of how thick the ISL should be and to make a determination on whether a RPL or CB is required.

#### b Model dimensions

The models were developed to replicate the structures described in Table 27 and had total thicknesses of:

- Primary Cover — 2.1 m;
- Option B — 2.3 m;
- Option E — 1.8 m; and
- Option I — 0.7 m.

#### c Mesh geometry

The model automatic mesh generation and automatic mesh refinement algorithms were used to generate the finite element mesh in the model.

#### d Initial conditions

##### *Duration*

The model was initially run for a 128-year period using patched climate data from SILO for Cloncurry Airport (the primary model run).

The model was run for a dry, average and wet year based on the 128 year patched SILO climate. That is:

- dry — 25<sup>th</sup> quartile — corresponding to ~307 mm of rainfall which was closest to 1980;
- average — the average — corresponding to 460 mm of rainfall which was closest to 1987; and
- wet — the wettest on record — corresponding to 1,156 mm of rainfall which was closest to 1974.

##### *Steady state conditions*

The steady state model run allowed the initial head condition within the model to reach a hydrostatic condition. The result of the steady state model run was used as the initial head condition for the dry, average and wet year scenarios.

##### *Physical characteristics*

The model requires SWCCs. A SWCC is the relationship between VWC and matric suction for each layer of the model. The model layers were built as per Table 27 using SWCCs derived from the pedotransfer function (Fredlund and Zing 1994).

The saturated hydraulic conductivity of the ISL was estimated to be  $9.96 \times 10^{-6}$  m/s, the saturated hydraulic conductivity for the RPL was  $2.89 \times 10^{-6}$  m/s and the saturated hydraulic conductivity of CB (waste rock) was estimated to be  $2.89 \times 10^{-5}$  m/s based on test results from Century Min (noting that the MMG 2018 physical characterisation data was not available at the time of preliminary modelling).

The saturated hydraulic conductivity of the sand used in CB was estimated to be  $\sim 2.31 \times 10^{-5}$  m/s using the method described by Rawles et al. (1983).

Hydraulic conductivity is the ability of the cover and tailings to transmit rainfall infiltration through the internal pore space and is defined by the rainfall infiltration velocity. The model derives unsaturated hydraulic conductivity curves from the SWCCs and the saturated hydraulic conductivity.

A schematic representation of each model is shown in Figure 16.

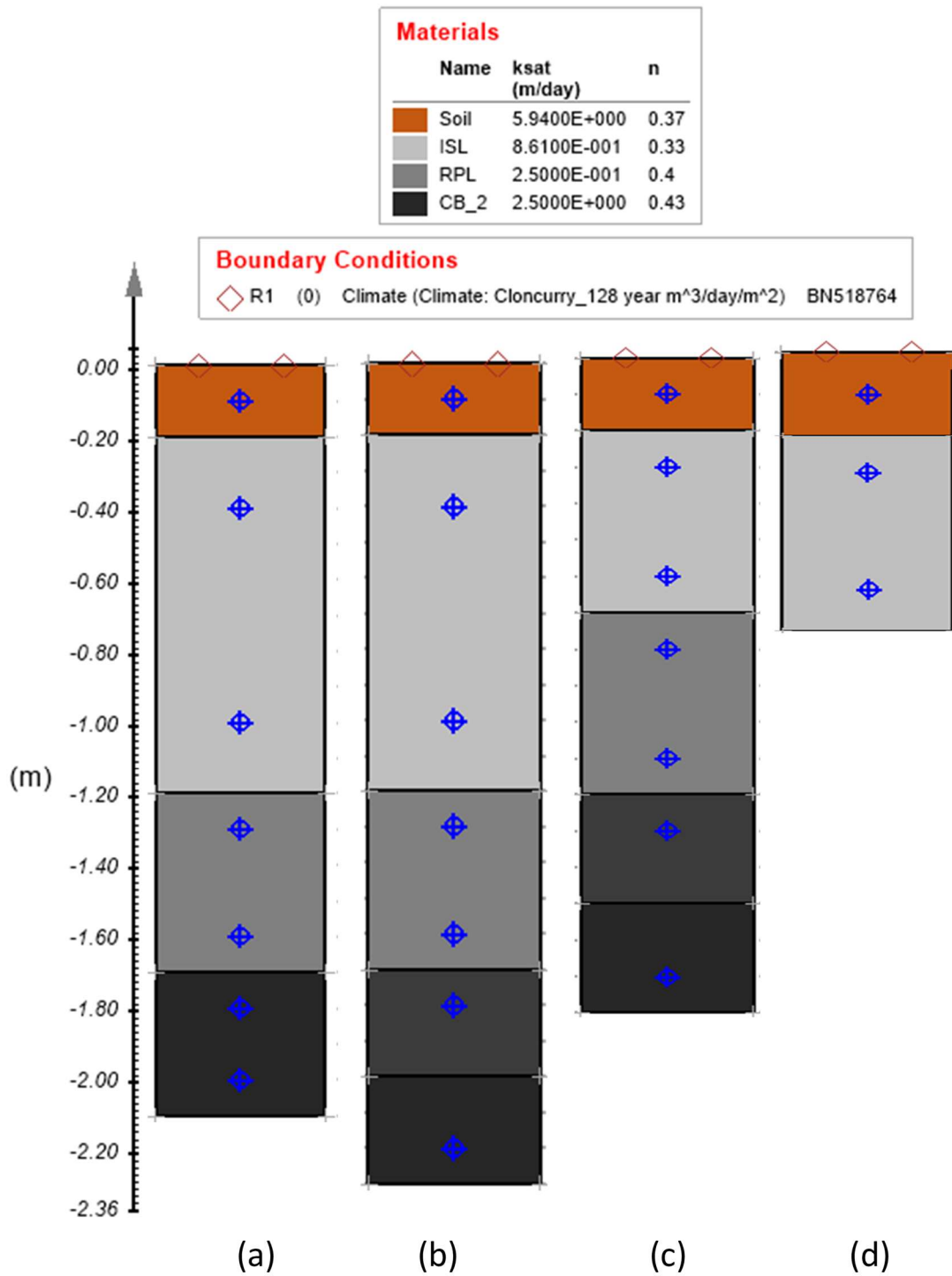


Figure 16 Model cross section (a) Primary Cover (b) Option B (c) Option E (d) Option I





## Appendix E – Matric suction sensor calibration method





The following methodology was used to calibrate the matric suction sensors:

1. Dry sensors in bucket of silicon beads for 48 hours (hrs).
2. Oven-dry all soil and tailings samples at 105°C for 24 hours. This is equivalent to 1,000,000 kPa of matric suction.
3. Place silicon dried sensors into oven dried soil and allow to come to equilibrium for 24 hrs. After 24 hrs the  $\Delta T$  is measured by wiring sensors to the data logger. Measured  $\Delta T$  is equivalent to matric suction at 1,000,000 kPa.
4. Dismantle and place sensors into a water chamber for 24 hours to completely saturate sintered ceramic heads. After 24 hours the  $\Delta T$  is measured by wiring sensors to the data logger. Measured  $\Delta T$  is equivalent to matric suction at 0 kPa. Sensors are not saturated under vacuum conditions as this will not be achievable prior to in-situ installation. Calibration aimed to replicate in-situ conditions as much as practicable.
5. Place air dried soil and tailings into cement mixer and wet up to saturation. Soil is laid out on a free draining table to allow excess water to drain off (this was the air-entry value/field capacity). This step takes about 12 hours to complete. Soil is then packed into jars to a density equal to field density. The sensors are allowed to come to equilibrium for 6 hours. After 6 hours the  $\Delta T$  is measured by wiring sensors to the data logger. Measured  $\Delta T$  is equivalent to matric suction at 10 kPa. Matric suction is confirmed by sub-sampling.
6. Sensors are then allowed to dry over a 6 day cycle with samples collected from close to the sensor on every other day.  $\Delta T$  is measured at the time of sampling. Sample temperature is allowed to come to equilibrium at approximately 25°C prior to sub-sampling.
7. Total suction is measured directly on all sub-samples using a water potential dew-point meter. Matric suction is calculated from EQ A.1 and EQ A.2.

$$\text{Total Suction} = \text{Matric suction} + \text{Osmotic suction} \quad \text{EQ A.1}$$

$$\text{Osmotic Suction} = 0.36 \times \text{EC (decisiemens per metre (dS /m))} \quad \text{EQ A.2}$$

The  $\Delta T$  is measured by reading the heating element temperature at one second and 30 seconds via a thermocouple embedded within the sensor head adjacent to the heating element.

Photograph 3 illustrates the experiment set up for calibration. Matric suction sensors are embedded at the expected field density and wired to the data logger ready for measuring the  $\Delta T$ .

Figure 17 illustrates the relationship between the calibration methodology and the SWCC. The calibration method was used to derive a four-point calibration function spanning the full range of expected matric suctions that may be encountered in-situ.



Photograph 3 Matrix suction sensor calibration

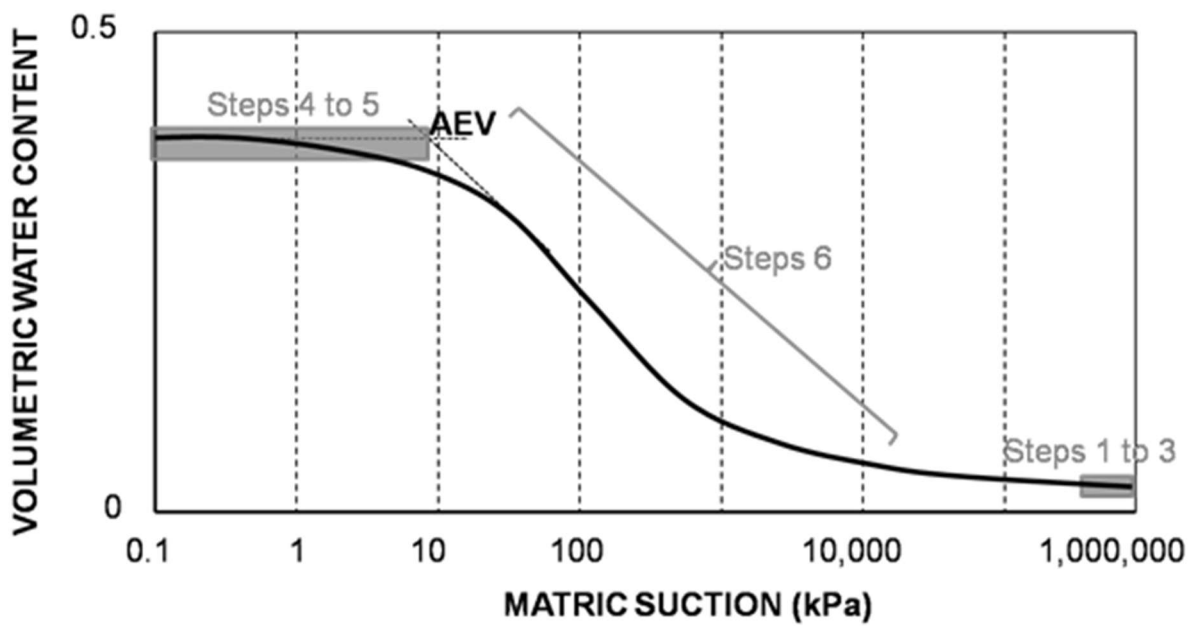
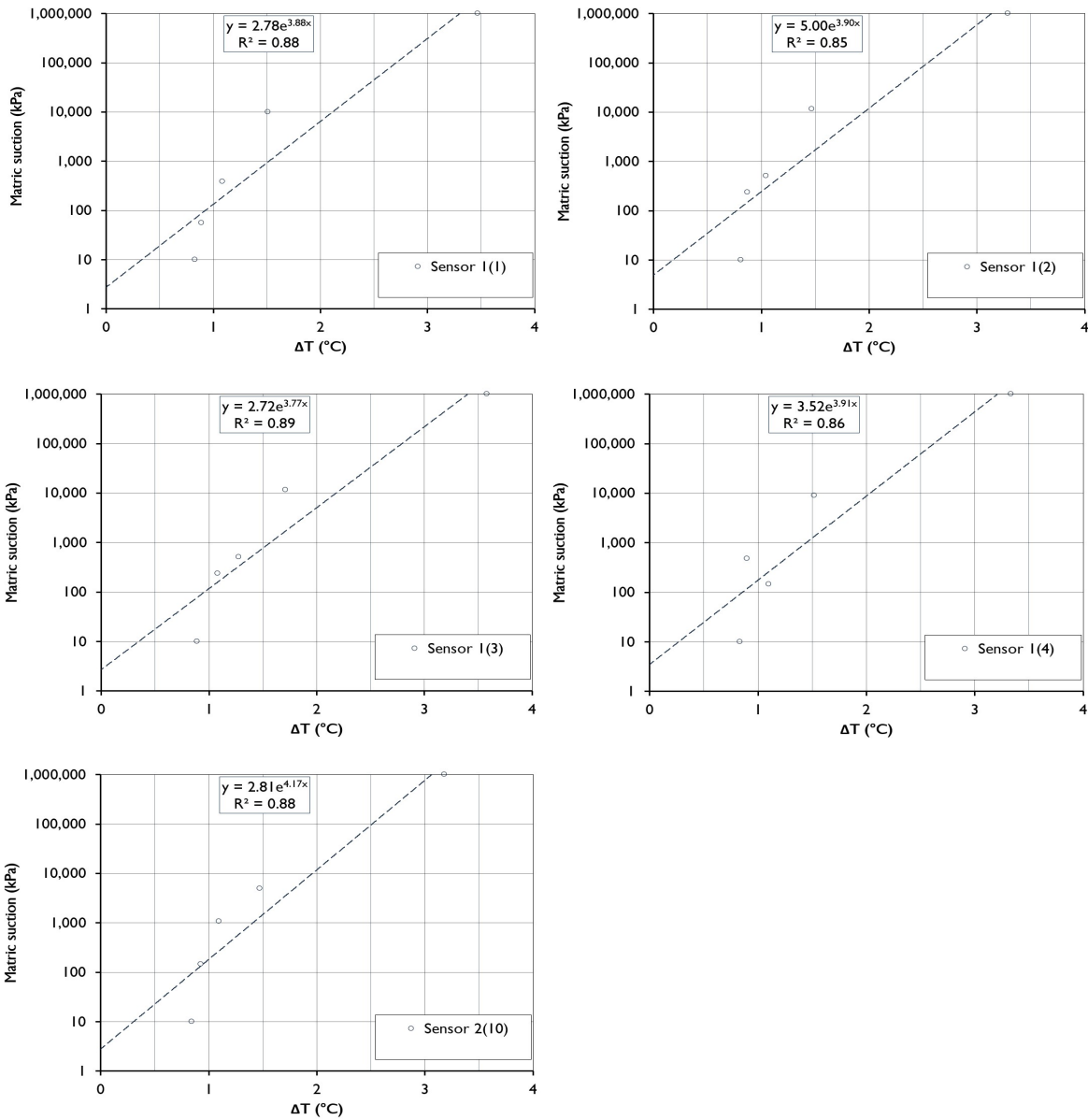


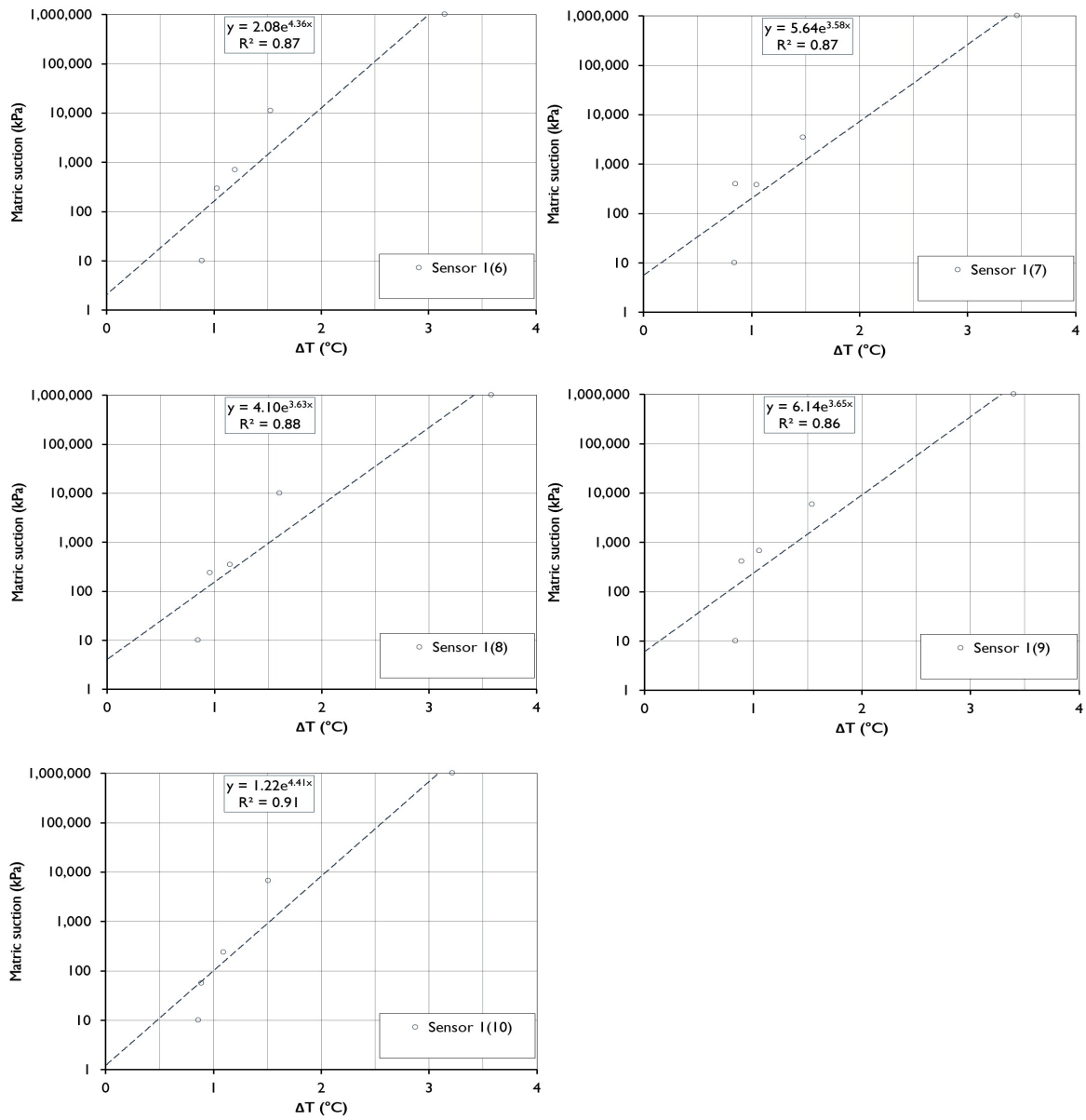
Figure 17 Generalised SWCC illustrating which part of the SWCC are measured by the calibration method



Appendix F – Matric suction sensor calibration results

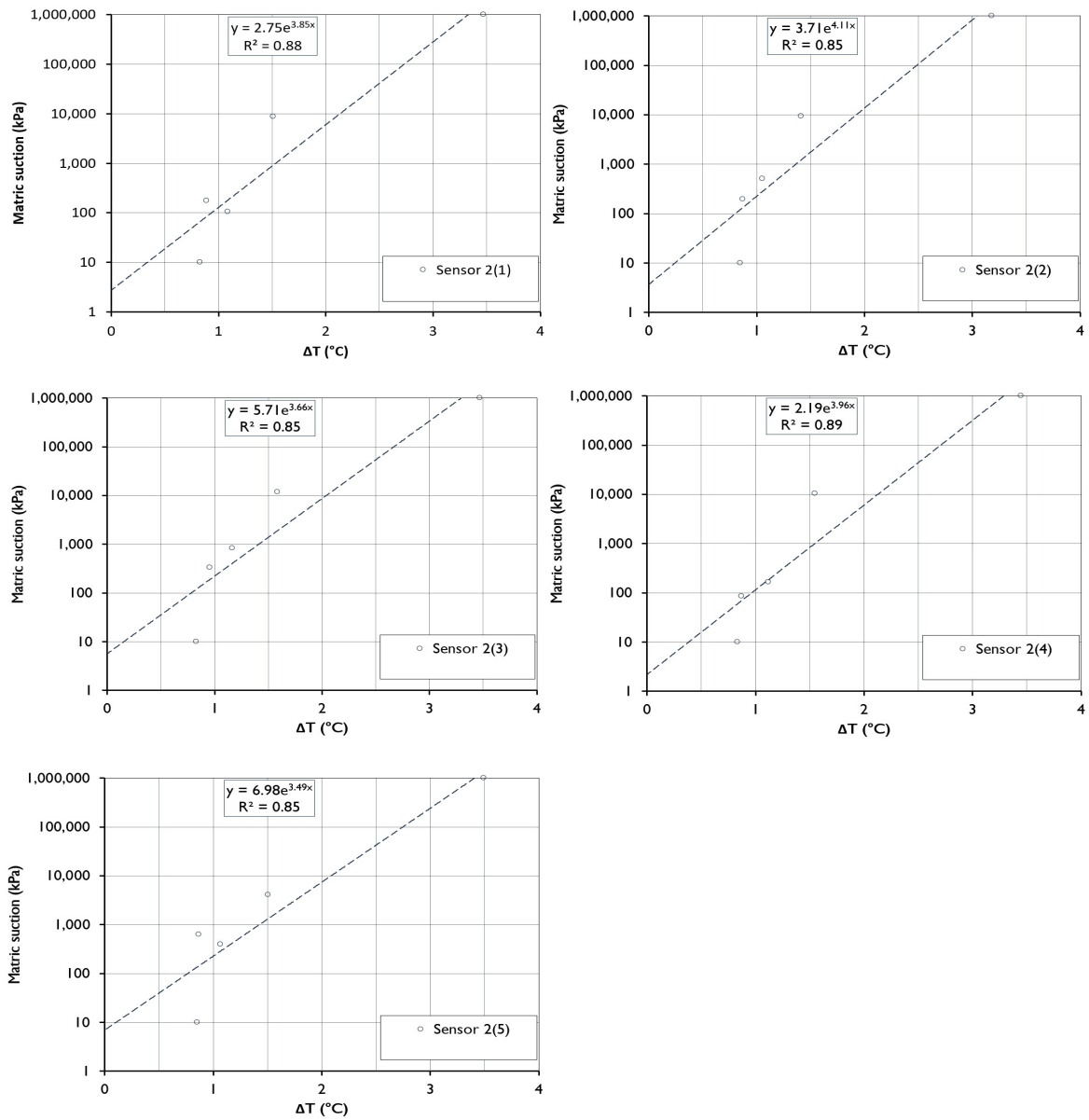


**Figure 18 Cover option I matric suction sensor calibration curves**

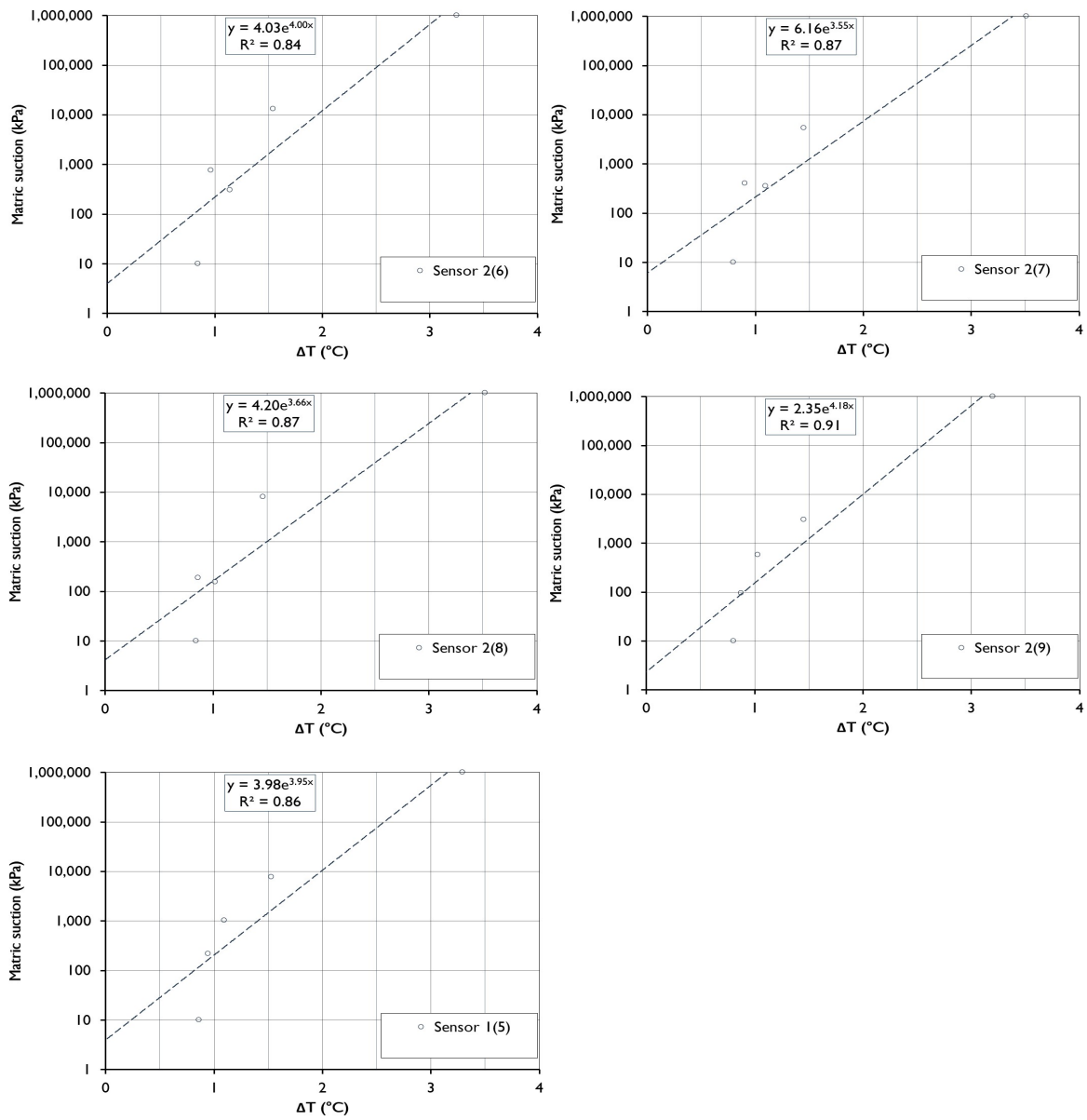


**Figure 19** Cover option 2 matric suction sensor calibration curves





**Figure 20** Cover option 3 matric suction sensor calibration curves



**Figure 21** Cover option 4 matric suction sensor calibration curves





**Appendix G – VWC and matric suction sensor results**



# Appendix G

## VWC and matric suction sensor results

### G.1 Matric suction

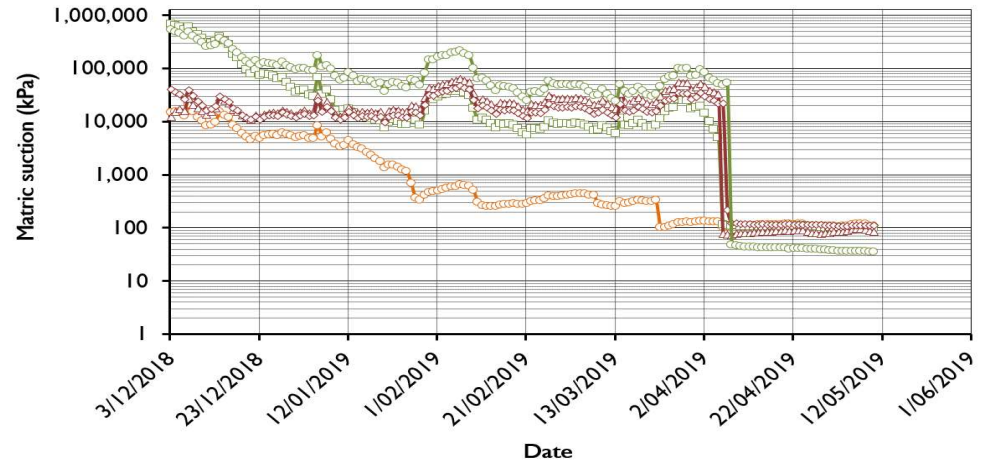
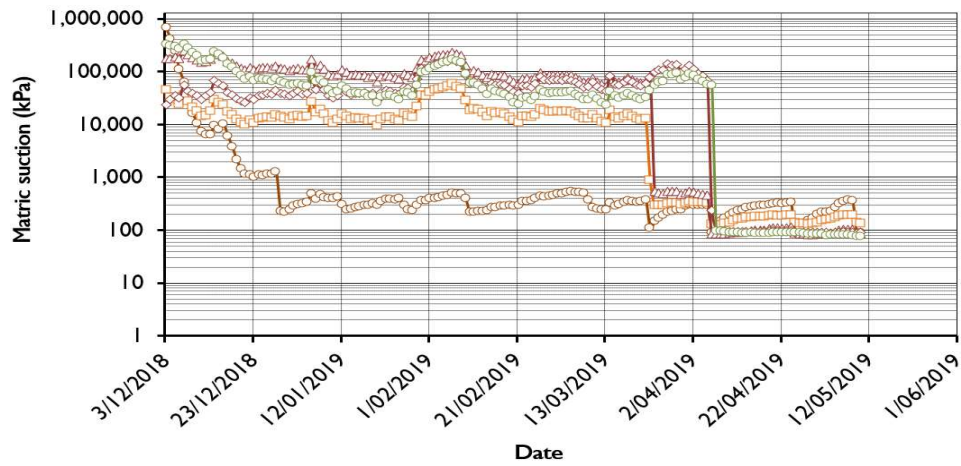
Figure 22 presents the matric suction results for the trials. Matric suction results for the tailings layer are not discussed as the in-situ data did not generate a complete SWCC (ie the relationship between VWC and matric suction in the tailings was not fully defined). Figure 22 shows that:

- the topsoil and CB layers are initially dry with matric suctions close to 1,000,000 kPa;
- the ISLs are initially dry with matric suctions between 1,000 kPa to 10,000 kPa;
- the RPLs are initially dry with matric suctions between 5,000 kPa to 200,000 kPa;
- upon wetting of the trials with artificial rainfall events, cover option 1 (Figure 22a):
  - the topsoil layer starts wetting up after 30 mm of rainfall before becoming saturated after 310 mm of rainfall (~100 kPa). Infiltration reaches the bottom of the ISL and top of the RPL after 310 mm of rainfall before becoming saturated after 510 mm of rainfall (~100 kPa). The bottom of the RPL and the CB both remain dry before becoming saturated after 510 mm of rainfall (~100 kPa and ~80 kPa respectively).
- upon wetting of the trials with artificial rainfall events, cover option 2 (Figure 22b):
  - the middle of the ISL starts wetting up after 150 mm of rainfall before reaching saturation after 510 mm of rainfall (~120 kPa). The RPL and both CBs remain dry before becoming saturated after 510 mm of rainfall.
- upon wetting of the trials with artificial rainfall events, cover option 3 (Figure 22c):
  - the middle of the ISL starts wetting up after 90 mm of rainfall before reaching saturation after 510 mm of rainfall. The top of the RPL and the upper CB were close to saturation after 150 mm of rainfall before reaching saturation after 510 mm of rainfall. The bottom of the RPL and the lower CB remain dry before becoming saturated after 510 mm of rainfall (~80 kPa and ~50 kPa respectively).
- upon wetting of the trials with artificial rainfall events, cover option 4 (Figure 22d):
  - the topsoil begins wetting up after 30 mm of rainfall before reaching saturation after 510 mm of rainfall (~100 kPa). The ISL begins wetting up after 90 mm of rainfall before reaching saturation after 510 mm of rainfall (~85 kPa).

The trials oscillate between near-saturated and unsaturated throughout. Once saturation was reached, however; the trials all trend towards near-saturated with time because the rate of artificial rainfall addition exceeds the rate of evaporation.

### G.2 VWC

Figure 23a to Figure 23d presents the VWC results for cover option 1 to cover option 4 respectively. Artificial rainfall is shown as an inset on the figure. The VWC results for the trials mirror the wetting and drying trends discussed in Section G.1 for matric suction and are not discussed further in this report.

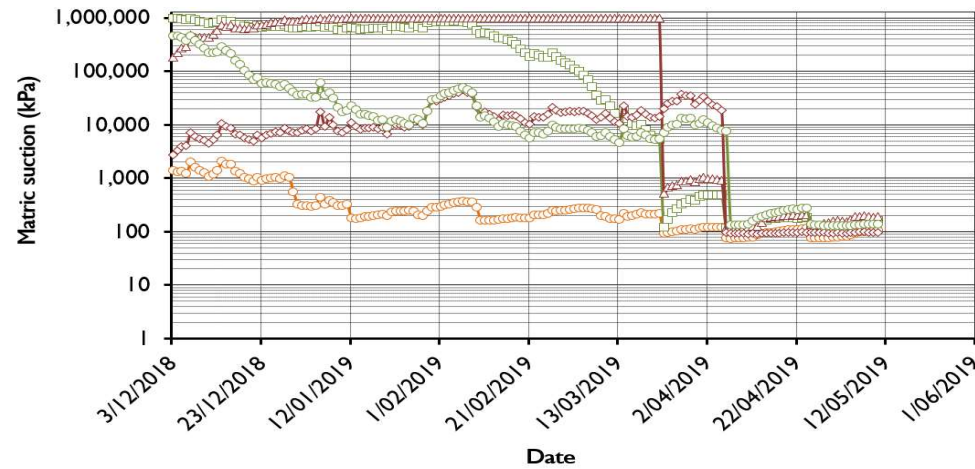


○ bottom of topsoil (0.3 m bgl)    □ bottom of ISL (1.2 m bgl)    ▲ top of RPL (1.4 m bgl)  
 ● bottom of RPL (1.7 m bgl)    ○ middle of capillary break (2 m bgl)

□ middle of ISL (0.7 m bgl)    □ middle of upper capillary break (1.5 m bgl)  
 ● top of RPL (1.7 m bgl)    ● bottom of RPL (2 m bgl)  
 ○ top of lower capillary break (2.2 m bgl)

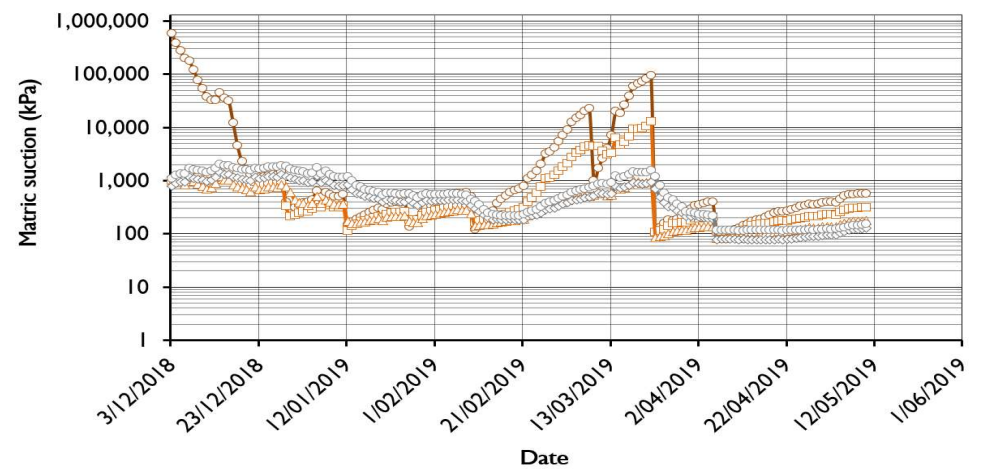
(a)

(b)



○ top of ISL (0.5 m bgl)    □ middle of upper CB (1 m bgl)  
 ● top of RPL (1.2 m bgl)    ● bottom of RPL (1.5 m bgl)  
 ○ top of lower capillary break (1.7 m bgl)

(c)

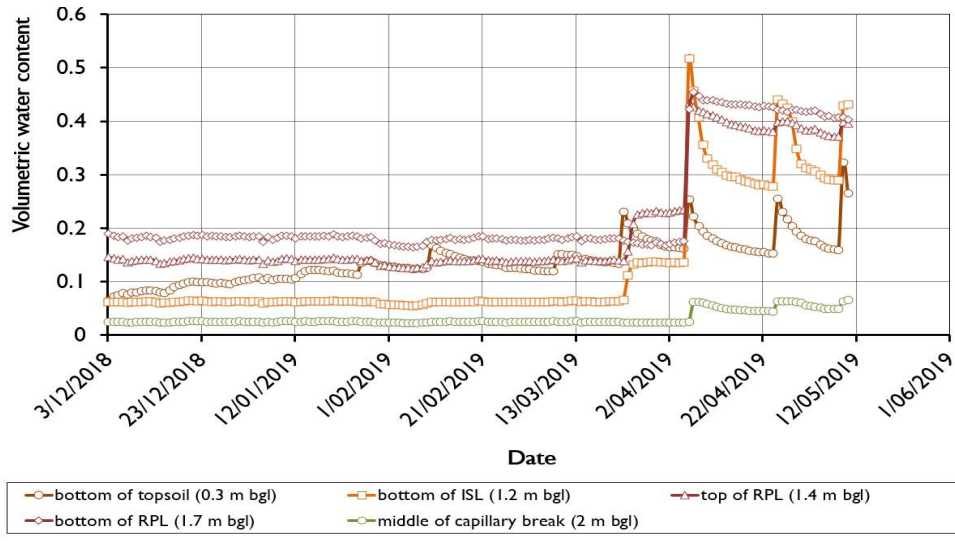


○ bottom of topsoil (0.3 m bgl)    □ top of ISL (0.5 m bgl)    □ bottom of ISL (0.7 m bgl)  
 ● top of tailings (0.9 m bgl)    ● bottom of tailings (1 m bgl)

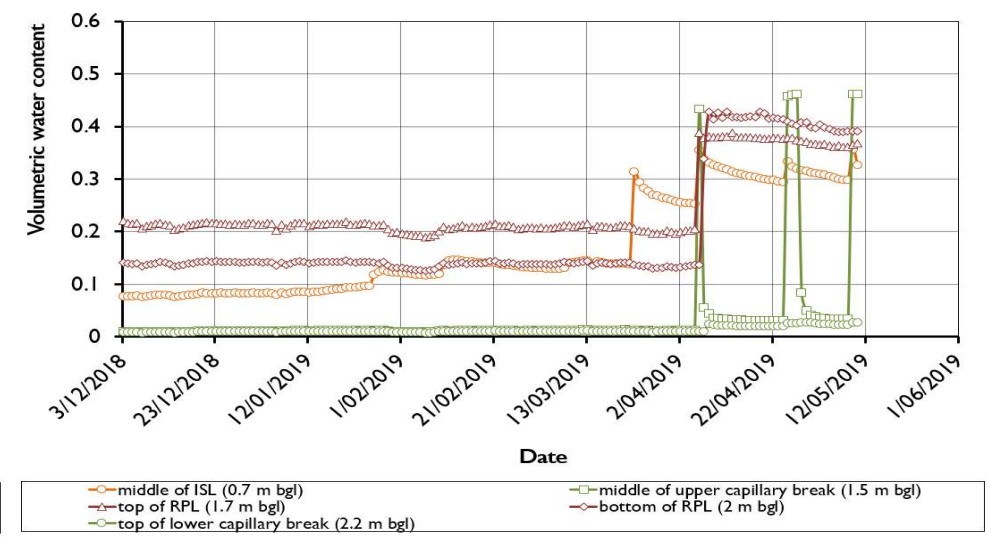
(d)

Figure 22 The trials matric suction results

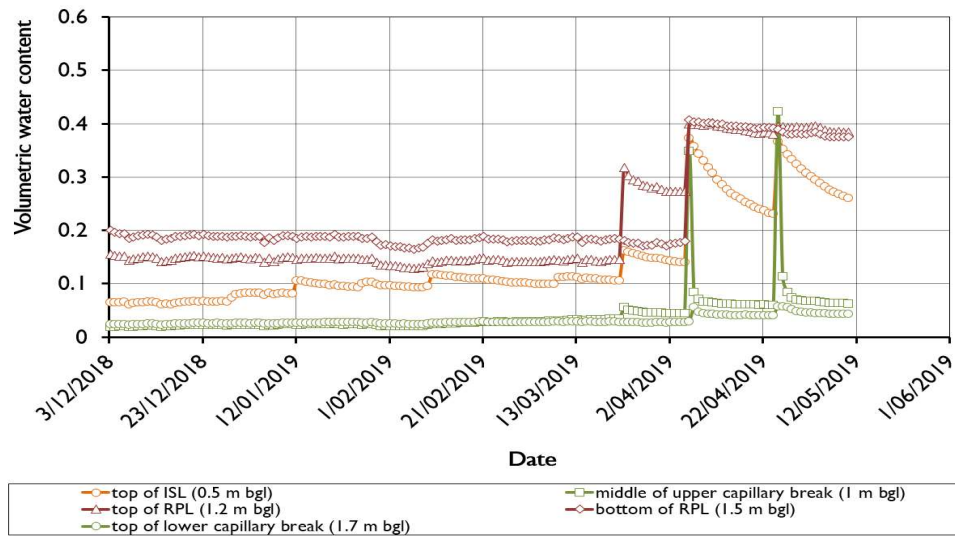




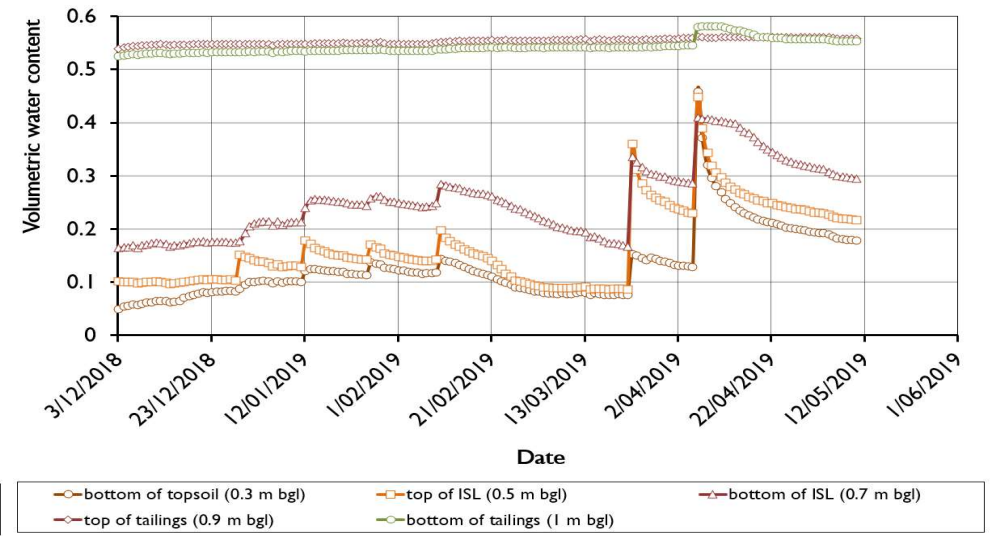
(a)



(b)



(c)



(d)

Figure 23 The trials VWC results

## Appendix H – Interpretation of SWCCs



The SWCC is fundamental to understanding unsaturated soil mechanics. It is a plot of soil water, conventionally in terms of volumetric water content = volume of water/total volume; but it could also be in terms of degree of saturation = volume of water/volume of voids; or gravimetric moisture content = mass of water/mass of solids, expressed as a %.

The key elements of the soil water characteristic curve are the following (Figure 24).

- The intercept on the vertical axis represents near-saturated conditions at the test density (the higher the density the lower the intercept, and increasing the density will induce drainage).
- The break in the curve at a high degree of saturation or high water content, referred to as the air-entry value (AEV) on drying, beyond which the material is unable to remain saturated, and air starts to replace any further moisture lost from the pores of the material. Up to the AEV, the material is essentially saturated (degree of saturation  $S > 85\%$ ) and suction effects can be ignored. The capillary rise in metres at the AEV =  $AEV/9.81$ .
- The slope of the curve at matric suctions higher than the AEV. The flatter the curve, the more water the material is able to store, and the harder it is to dewater (that is, the higher the applied pressure required to effect dewatering). Over this portion of the curve, matric (or capillary) suction and liquid water flow dominate.
- The break in the curve at a low degree of saturation or low water content, referred to as the water-entry value (WEV) on re-wetting, beyond which osmotic suction and water vapour flow dominate. The WEV is the suction at which the material starts to rapidly wet up on re-wetting. As the material dries beyond the WEV, the salt concentration of the diminishing pore water increases and so too does the osmotic suction. Beyond the WEV, further dewatering is more difficult to achieve, as evidenced by the flatter curve. Evaporation continues unabated to about 3,000 kPa suction, thereafter decreasing at an increasing rate and ceasing at a suction of about 100,000 kPa.
- The oven-dry (zero moisture) state corresponds to a suction of 1,000,000 kPa, for all materials.
- There is a hysteresis between drying and re-wetting cycles. As a soil desaturates, moisture is first lost from the largest pores, with residual moisture retreating to ever-finer pores, requiring ever-higher matric suctions to remove it. As a soil re-wets, the largest pores saturate first, with the finer pores saturating last, but at much lower matric suctions than were required to drain them during the drying cycle.

Over the suction range up to about 1,000 kPa, matric (or capillary) suctions dominate, while above about 1,000 kPa the increasing concentration of salts in the pore water mean that osmotic (or solute) suctions come to dominate. Most soil-like materials exist at a suction of  $< 10,000$  kPa, and hence matric suction usually dominates. An exception is salt pan deposits and hypersaline tailings.



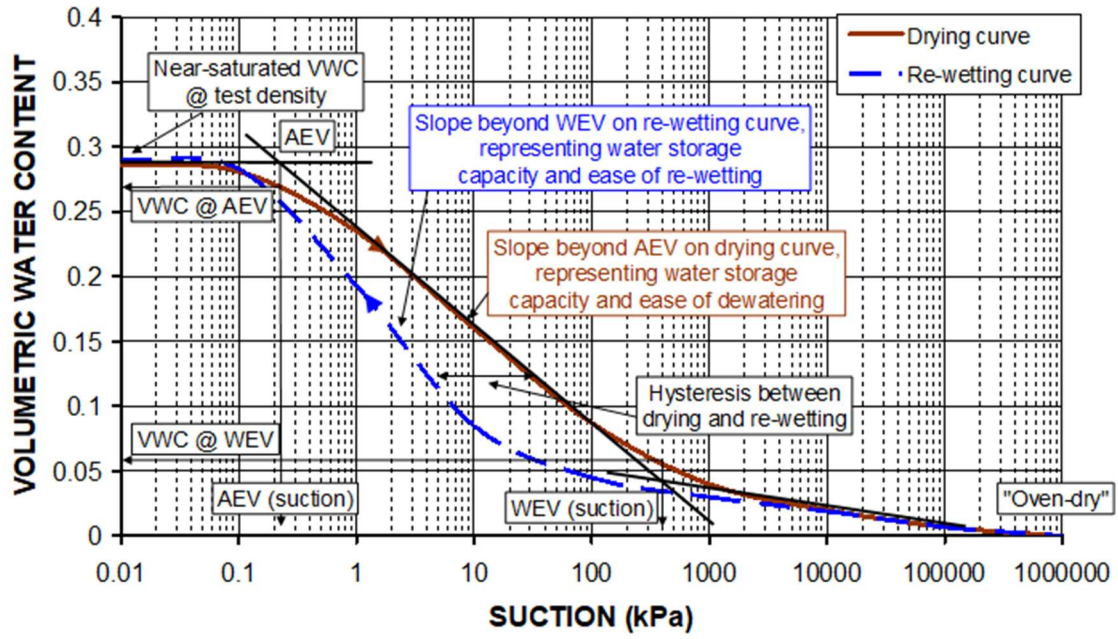


Figure 24 Key elements of the SWCC

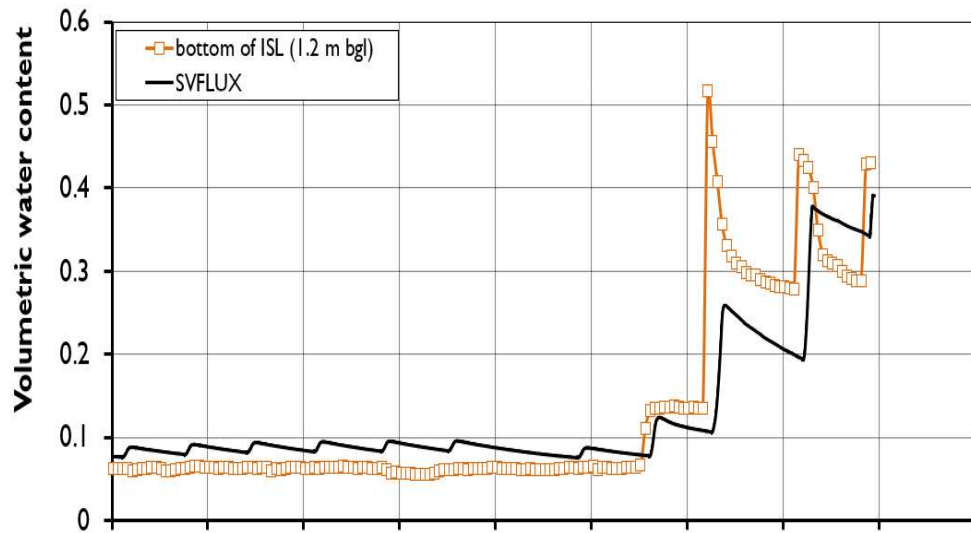


The image shows four identical grey metal test rigs arranged in a row. Each rig consists of a vertical column with a horizontal base and a top section. The rigs are numbered 1, 2, 3, and 4 from left to right. A white electrical control cabinet is mounted on the second rig. Numerous black cables are connected to the rigs and are bundled on the floor. The background is a white corrugated metal wall.

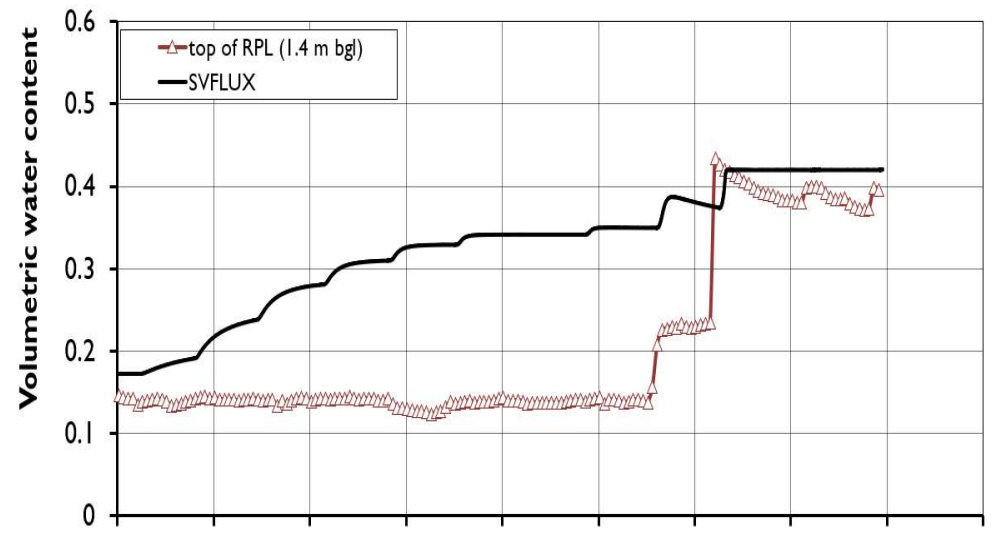
## Appendix I – Additional model results compared to the trials

In Figure 25:

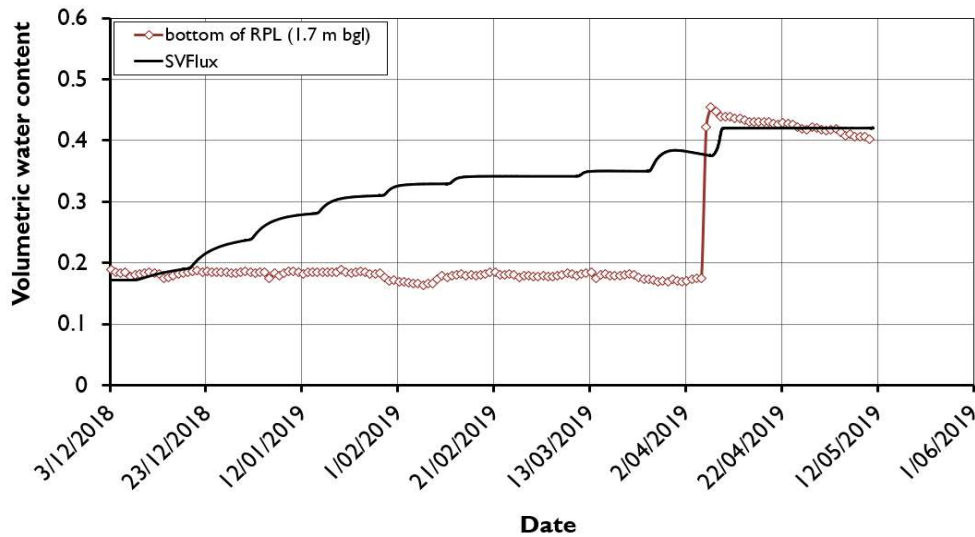
- Figure 25a shows the results of model bottom of ISL VWC prediction compared to the in-situ results for cover option 1;
- Figure 25b shows the results of model top of RPL VWC prediction compared to the in-situ results for cover option 1;
- Figure 25c shows the results of model bottom of RPL VWC prediction compared to the in-situ results for cover option 1;
- Figure 25d shows the results of model middle of CB VWC prediction compared to the in-situ results for cover option 1;
- Figure 25e shows the results of model middle of ISL VWC prediction compared to the in-situ results for cover option 2;
- Figure 25f shows the results of model middle of upper CB VWC prediction compared to the in-situ results for cover option 2;
- Figure 25g shows the results of model top of RPL VWC prediction compared to the in-situ results for cover option 2;
- Figure 25h shows the results of model bottom of RPL VWC prediction compared to the in-situ results for cover option 2;
- Figure 25i shows the results of model top of lower CB VWC prediction compared to the in-situ results for cover option 2;
- Figure 25j shows the results of model topsoil VWC prediction compared to the in-situ results for cover option 4;
- Figure 25k shows the results of model top of ISL VWC prediction compared to the in-situ results for cover option 4; and
- Figure 25l shows the results of model bottom VWC prediction compared to the in-situ results for cover option 4;



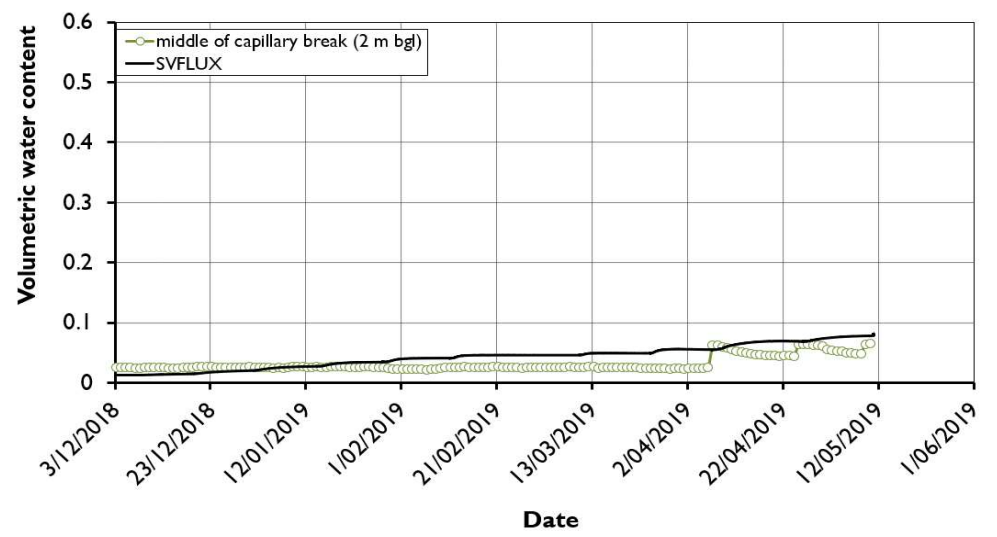
(a)



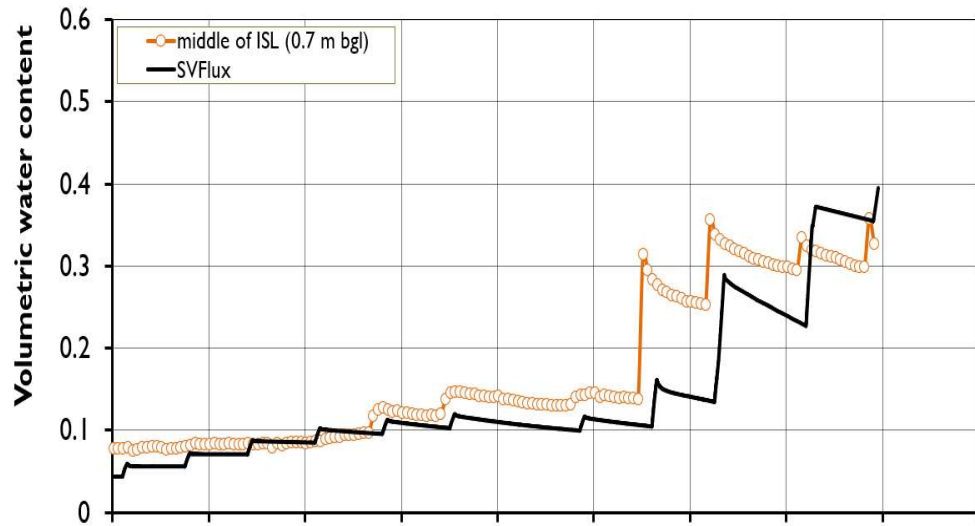
(b)



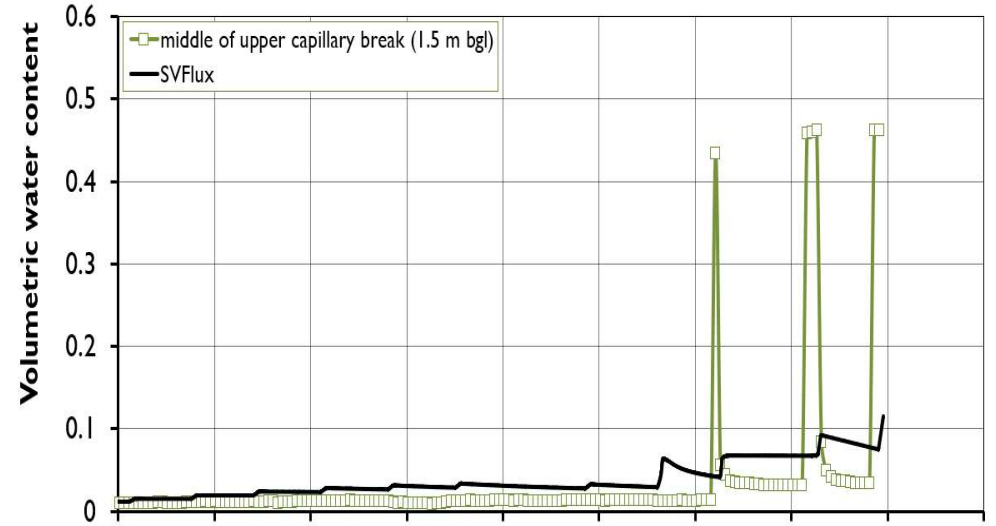
(c)



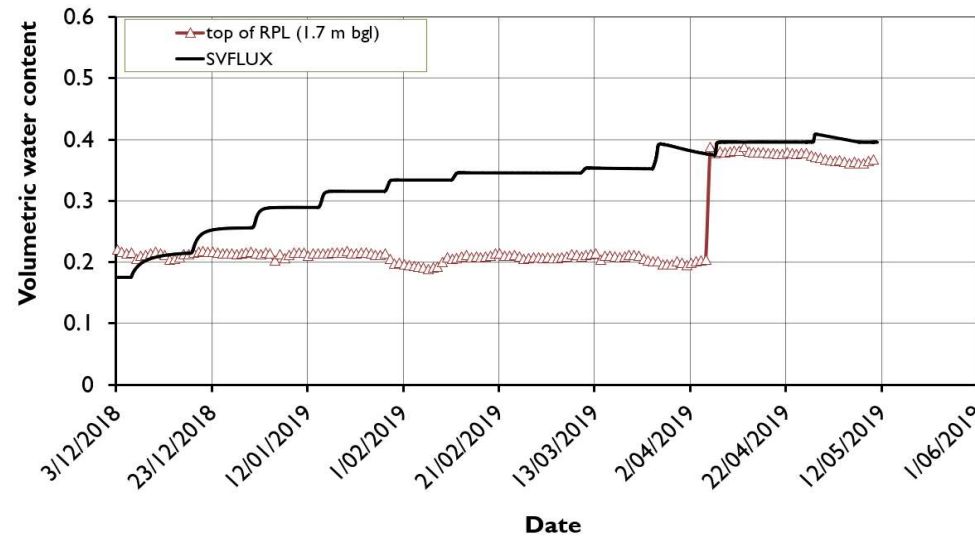
(d)



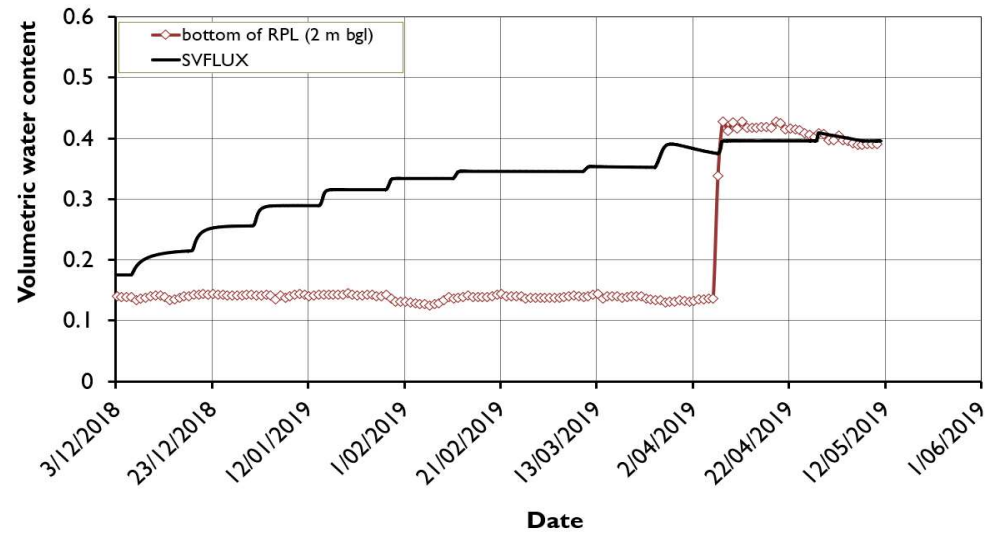
(e)



(f)

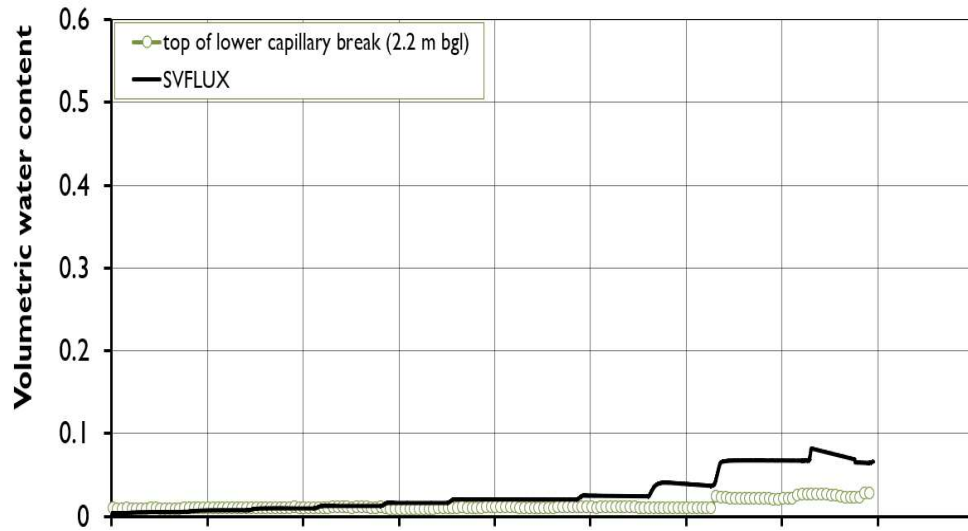


(g)

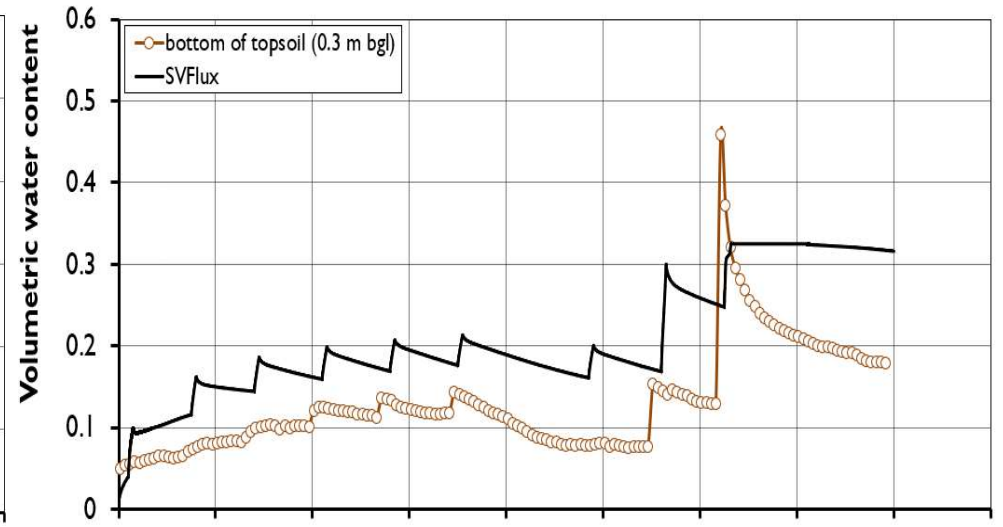


(h)

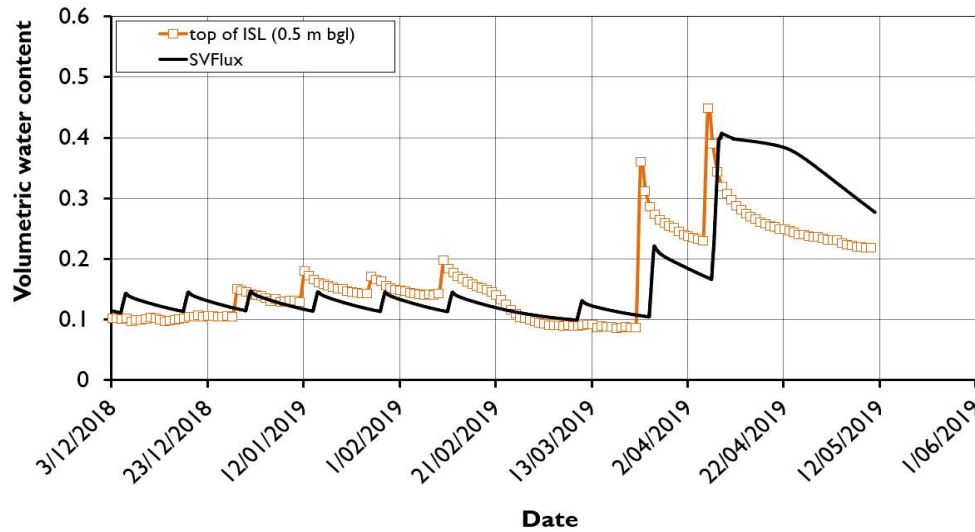




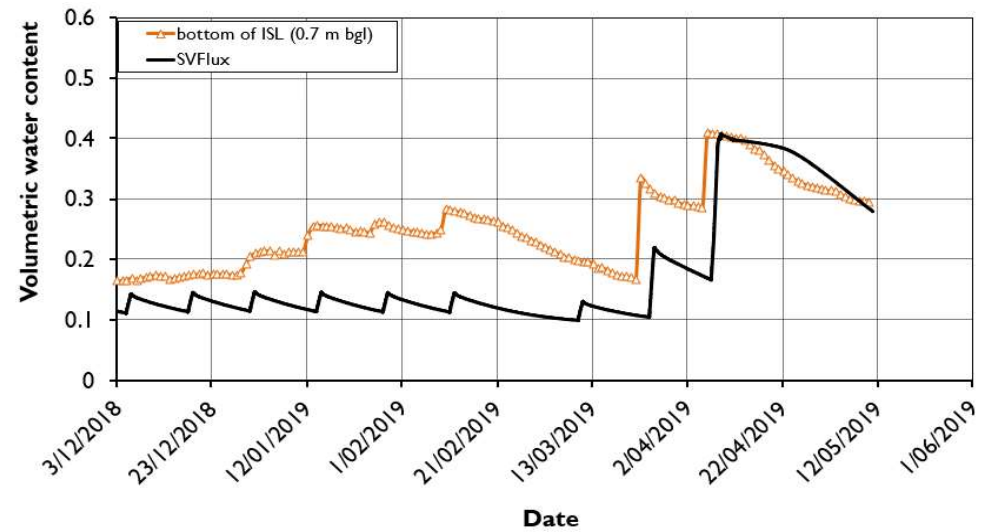
(i)



(j)



(k)



(l)

**Figure 25 Model results compared to the trials**

*This page is intentionally blank*

### About SGM environmental Pty Limited

We are a boutique consulting firm of experienced leading industry experts working with our clients and their stakeholders to develop and deliver innovative solutions to complicated challenges that create enduring value.

SGM environmental Pty Limited (SGME) was established to provide services in soil science, geochemistry, mine closure and environmental approvals and science cost efficiently. When you engage SGME you engage a partner to your business, priding themselves on:

- Positivity — We won't back down from a project because it's difficult. We thrive on the challenge.
- Trust — We say what we mean and we will deliver on our promises. We will advocate strongly for you.
- Innovation — We will always look for new ways to help and create enduring value because that is what friends do when they work together.
- Safety — We will share mutual responsibility to prevent harm and promote wellbeing.

For more information, please visit:

[www.sgmenvironmental.com](http://www.sgmenvironmental.com)

### Australian Locations

Brisbane



## **Appendix F: TSF and Process Area Hydraulic Impact Assessment (ATC Williams, 2021)**



# REPORT

**MMG AUSTRALIA PTY LTD**  
ABN: 14 069 603 587

**Dugald River Mine – Progressive  
Closure and Closure Planning – TSF  
and Process Area Hydraulic Impact  
Assessment**

108003-49  
MAY 2021





## Document Control

Project Name: Dugald River Mine – Progressive Closure and Closure Planning  
Document Title: TSF and Process Area Hydraulic Impact Assessment  
File Location: M:\Synergy\Projects\108\108003 Dugald River Mine\49 Progressive Rehabilitation & Closure Plan\Documents\R01\Text\108003-49R01-rev1.docx  
Project Number: 108003-49  
Revision Status: 1

## Revision History

Revision	Issue	Prepared by	Reviewed by
A	Draft Issue	James Parker & Matthew Plucknett	Naomi Tyack
0	Final Issue	James Parker & Matthew Plucknett	Naomi Tyack
1	Final Issue – Updated	James Parker & Matthew Plucknett	Naomi Tyack

## Issue Register

Distribution List	Date
MMG Australia Pty Ltd	18 May 2021 – Revision A
MMG Australia Pty Ltd	28 May 2021 – Revision 0
MMG Australia Pty Ltd	31 May 2021 – Revision 1

## ATC Williams Company Details

Prepared By:	James Parker & Matthew Plucknett
Approved By:	Nicola Logan
Address:	Level 2, 16-20 Edmondstone Street, Newmarket QLD 4051
Tel:	07 3352 7222
Email:	<a href="mailto:brisbane@atcwilliams.com.au">brisbane@atcwilliams.com.au</a>

© ATC Williams Pty Ltd (ATCW). All rights reserved.

ATCW has prepared this document solely for the use of the person or company to whom it is addressed, each as expressly stated in the document. No other party should rely on this document without the prior written consent of ATCW. No responsibility or liability to any third party is accepted for any damages howsoever arising out of the use of this report by any third party.

Your attention is drawn to Conditions of Report attached to this document. These conditions are an integral part of the document and must be reproduced with every copy.



## CONTENTS

<b>1</b>	<b>INTRODUCTION</b>	<b>1</b>
1.1	Background and Purpose	1
1.2	Site Watercourses/Drainage Setting	2
1.3	Project Scope and Methodology	3
1.4	Structure of Report	3
<b>2</b>	<b>HYDROLOGY ASSESSMENTS</b>	<b>4</b>
2.1	Overview	4
2.2	Probable Maximum Precipitation	4
2.3	Rare Precipitation Estimation	5
2.4	Regional Flood Frequency Estimate	7
<b>3</b>	<b>HYDRAULIC ASSESSMENT</b>	<b>9</b>
3.1	Model Overview	9
3.2	Model Domain, Grid Size and Time Step	9
3.2.1	Domain	9
3.2.2	Topography	10
3.2.3	TSF Closure Surface	11
3.2.4	TSF Closure Spillway	11
3.2.5	Grid Size and Time Step	11
3.3	Boundary Conditions	12
3.4	Surface Roughness	13
3.5	Sensitivity Analysis	14
<b>4</b>	<b>RESULTS AND IMPACTS</b>	<b>15</b>
4.1	General	15
4.2	TSF	16
4.3	Portals and Tributaries	16
4.4	Sensitivity Outcomes	20
<b>5</b>	<b>PCRP INPUTS</b>	<b>22</b>
5.1	Mine Portals	22
5.2	TSF	22
<b>6</b>	<b>SUMMARY AND CONCLUSION</b>	<b>23</b>
	<b>REFERENCES</b>	<b>24</b>

## TABLES

<b>TABLE 1: COINCIDENT FLOODING SCENARIOS</b>	<b>4</b>
<b>TABLE 2: GSDM FACTORS FOR PMP ESTIMATE</b>	<b>4</b>
<b>TABLE 3: PMP RAINFALL DEPTH ESTIMATE</b>	<b>5</b>
<b>TABLE 4: RARE RAINFALL DEPTH ESTIMATES</b>	<b>6</b>
<b>TABLE 5: RFFE MEAN DISCHARGE SUMMARY</b>	<b>7</b>
<b>TABLE 6: TSF CLOSURE SPILLWAY DETAILS</b>	<b>11</b>
<b>TABLE 7: HYDRAULIC MODEL SIMULATION TIME</b>	<b>11</b>
<b>TABLE 8: BOUNDARY CONDITIONS</b>	<b>13</b>
<b>TABLE 9: TSF PEAK FLOWS</b>	<b>16</b>
<b>TABLE 10: TSF SPILLWAY IMPACTS</b>	<b>16</b>
<b>TABLE 11: NORTH PORTAL IMPACTS</b>	<b>17</b>
<b>TABLE 12: SOUTH PORTAL IMPACTS</b>	<b>17</b>
<b>TABLE 13: PROCESS AREA TRIBUTARY PEAK WATER SURFACE ELEVATIONS</b>	<b>18</b>
<b>TABLE 14: PROCESS AREA TRIBUTARY MAXIMUM VELOCITIES</b>	<b>19</b>



---

TABLE 15: PORTAL SENSITIVITY IMPACTS .....	20
TABLE 16: TSF SPILLWAY IMPACTS – MAXIMUM DEPTH.....	20
TABLE 17: TSF SPILLWAY IMPACTS – MAXIMUM FLOW RATE .....	21

## DIAGRAMS

DIAGRAM 1: SITE LOCATION .....	1
DIAGRAM 2: SITE TRIBUTARIES AND INFRASTRUCTURE.....	2
DIAGRAM 3: PMP RAINFALL DEPTH ESTIMATE.....	5
DIAGRAM 4: RFFE CATCHMENTS .....	8
DIAGRAM 5: TUFLOW MODEL DOMAIN.....	9
DIAGRAM 6: TOPOGRAPHICAL INPUTS .....	10
DIAGRAM 7: BOUNDARY LOCATIONS.....	12
DIAGRAM 8: MANNINGS ROUGHNESS .....	13
DIAGRAM 9: PEAK FLOOD LEVEL LOCATIONS .....	15
DIAGRAM 10: PROCESS AREA - PMP FLOOD DEPTH .....	18
DIAGRAM 11: PROCESS AREA FLOOD LEVEL LOCATIONS.....	19

## FIGURES

FIGURE 001 – TSF PROBABLE MAXIMUM FLOOD– MAXIMUM FLOOD DEPTHS
FIGURE 002 – TSF PROBABLE MAXIMUM FLOOD – MAXIMUM FLOOD VELOCITY
FIGURE 003 – TSF 0.1 % AEP – MAXIMUM FLOOD DEPTHS
FIGURE 004 – TSF 0.1 % AEP – MAXIMUM FLOOD VELOCITY
FIGURE 005 – TSF 1 % AEP – MAXIMUM FLOOD DEPTHS
FIGURE 006 – TSF 1 % AEP – MAXIMUM FLOOD VELOCITY
FIGURE 007 – PROCESS AREA PROBABLE MAXIMUM FLOOD– MAXIMUM FLOOD DEPTHS
FIGURE 008 – PROCESS AREA PROBABLE MAXIMUM FLOOD – MAXIMUM FLOOD VELOCITY
FIGURE 009 – PROCESS AREA 0.1 % AEP – MAXIMUM FLOOD DEPTHS
FIGURE 010 – PROCESS AREA 0.1 % AEP – MAXIMUM FLOOD VELOCITY
FIGURE 011 – PROCESS AREA 1 % AEP – MAXIMUM FLOOD DEPTHS
FIGURE 012 – PROCESS AREA 1 % AEP – MAXIMUM FLOOD VELOCITY

## APPENDICES

APPENDIX A: PMP CALCULATIONS
APPENDIX B: MMG CLOSURE CONCEPT (2016)

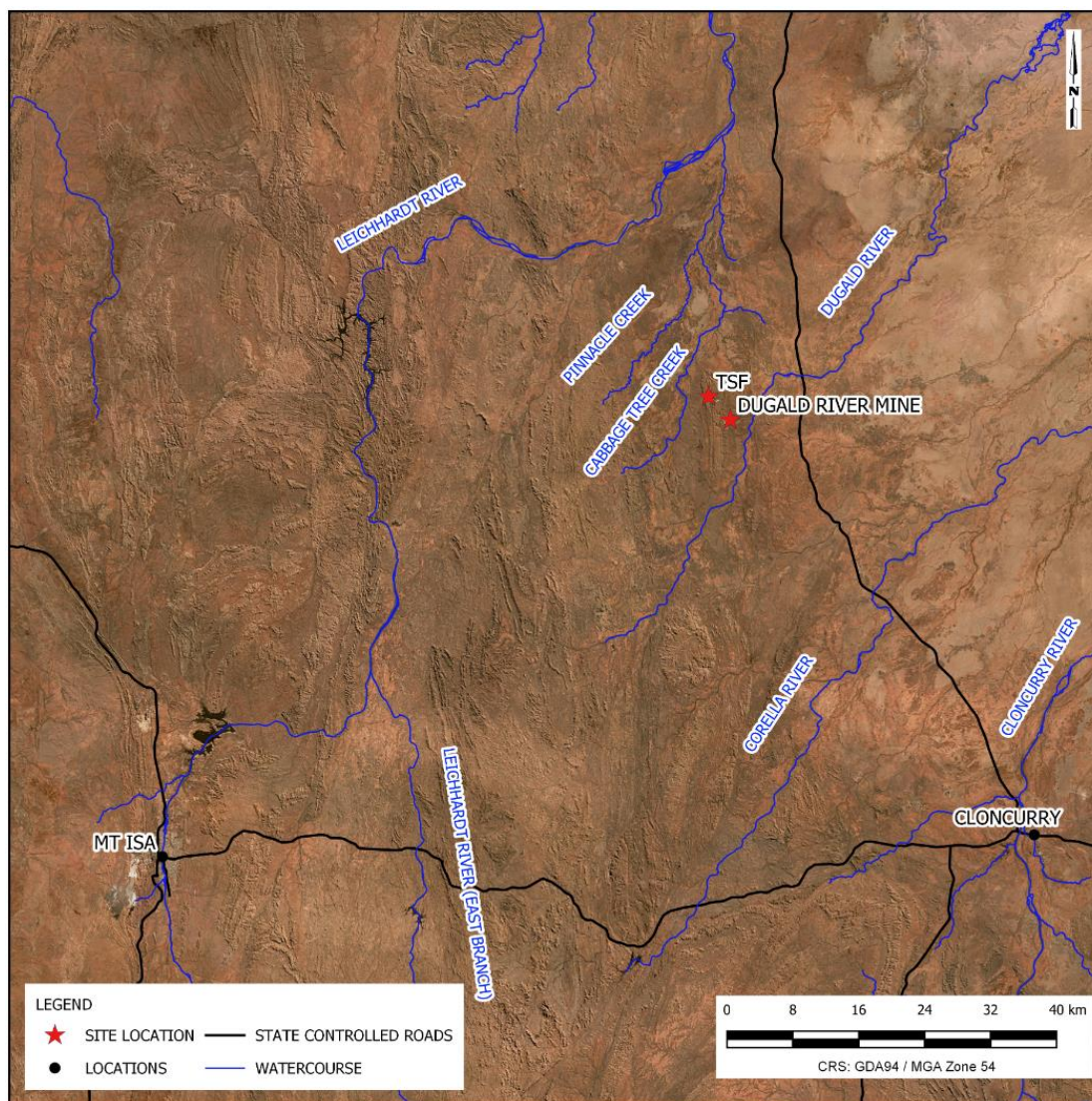


# 1 INTRODUCTION

## 1.1 Background and Purpose

MMG Australia Pty Ltd (MMG) owns and operates the Dugald River Mine (DRM) in northwest Queensland. The DRM is located approximately 60 km northwest of Cloncurry and is accessed from the Burke Development Road. DRM and its TSF locations are shown on **DIAGRAM 1**.

**DIAGRAM 1: SITE LOCATION**



The purpose of this study is to provide flood modelling in support of the DRM Progressive Closure and Rehabilitation Plan (PCRP). The PCRP requires flood risk assessments for two aspects of closure: to identify whether any mine voids will be in a floodplain post-closure; and to assess the flood risk to remaining infrastructure (in this case the closed and capped TSF). The floodplain is defined under the PCRP as being areas within the 0.1% AEP flood level.



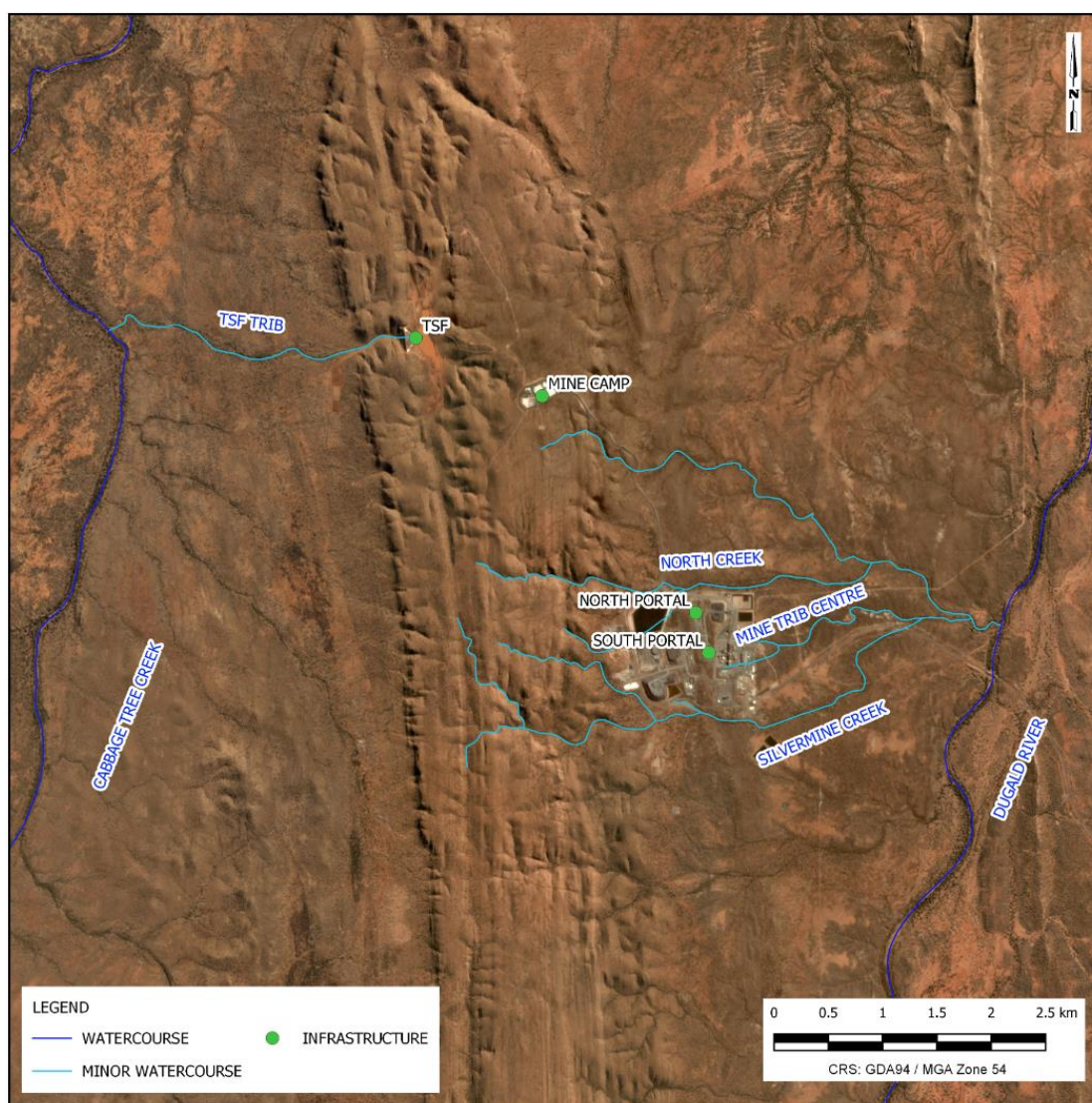


## 1.2 Site Watercourses/Drainage Setting

The DRM is located approximately 3 km west of the Dugald River. The TSF is located in the adjacent catchment, approximately 3 km east of Cabbage Tree Creek, as shown on **DIAGRAM 2**. The Dugald River is located within the Flinders River Basin, whereas Cabbage Tree Creek is located in the Leichardt River Basin. Both the Flinders River and Leichardt River discharge into the Gulf of Carpentaria.

Within the DRM area there are several small tributaries of the Dugald River, namely North Creek and Silvermine Creek. For the purpose of this study, the unnamed tributary to the centre of the DRM area has been named 'Mine Trib Centre'. The single tributary to Cabbage Tree Creek has been named 'TSF Trib'. The locations of these tributaries are depicted on **DIAGRAM 2**, along with key existing mine infrastructure.

**DIAGRAM 2: SITE TRIBUTARIES AND INFRASTRUCTURE**







### 1.3 Project Scope and Methodology

The scope of works for the PRCP and updated flood study consist of:

- Hydrologic assessment of the site and upstream catchments.
- Hydraulic modelling of the site and upstream catchments.

As part of the PCRCP, a flood profile for the TSF and DRM was required to be developed. In consultation with MMG, it was agreed to model the following events:

- Probable Maximum Flood (PMF) resulting from the Probable Maximum Precipitation (PMP);
- 1:1,000 AEP (0.1% AEP); and,
- 1:100 AEP (1% AEP) storm events.

Australian Rainfall and Runoff (ARR) (2019) [1] has been utilised to develop the rainfall estimates for input into a TUFLOW hydraulic model. Due to the size of the upstream catchments, the Regional Flood Frequency Estimation (RFFE) tool [2] was proposed to be used to estimate the peak discharges in the Dugald River and Cabbage Tree Creek that would be applied in the hydraulic model. Further details regarding the methodology and application of the RFFE is provided in **Section 3.0**.

### 1.4 Structure of Report

The structure of the report, to address the above scope of works, is as follows.

- Section 2.0** Details the inputs and outcomes of the rainfall estimation process for the 1% AEP and PMP design events. The inputs from the Regional Flood Frequency Estimate (RFFE) for the Dugald River and Cabbage Tree Creek upstream catchment are presented.
- Section 3.0** Details the development and outcomes of the TUFLOW hydraulic model utilised for determining the response of site areas to the hydrographs determined in **Section 2.0**.
- Section 4.0** This section discusses the results of the base case and the design case scenarios, plus the sensitivity analyses outcomes.
- Section 5.0** Discusses the hydraulic assessment with respect to the PRCP.
- Section 6.0** Outlines the conclusions and recommendations from the hydraulic assessment.



## 2 HYDROLOGY ASSESSMENTS

### 2.1 Overview

Upstream of the TSF and DRM areas the catchments are relatively small at 335 ha and 750 ha, respectively. The catchments have short times of concentration when compared the full regional catchments within which they are located. As such, the regional and local extreme storm events have very different characteristics and the impact of regional flooding from Cabbage Tree Creek and the Dugald River will be experienced hours after any rainfall at the TSF and DRM sites has passed. As a result of this, coincident flood event scenarios for the local mine site and TSF and the regional catchments have been applied, as detailed in **TABLE 1**.

**TABLE 1: COINCIDENT FLOODING SCENARIOS**

Site Rainfall Event	Dugald River/Cabbage Tree Creek Rainfall Event
PMP	1.0 % AEP
0.1 % AEP	1.0 % AEP
1 % AEP	5% AEP

The input hydrology for the PMP, 1:1,000, 1:100 and 1:20 AEP events was developed in accordance with ARR (2019) [1], in line with the PRCP Guideline requirements. Development of the hydrology estimates for the TSF and DRM sites is detailed in **Sections 2.2** and **2.3**, below. The hydrology estimation methodology for the Dugald River and Cabbage Tree Creek is detailed in **Section 2.4**.

### 2.2 Probable Maximum Precipitation

The DRM site is located in the Generalised Tropical Storm coastal zone and therefore the Generalised Short Duration Method (GSDM) [3] was adopted for event durations between 0.25 hours and 6 hours.

The GSDM method requires catchment factors to be applied to the initial rainfall depth to estimate the PMP for the site. The GSDM factors are summarised in **TABLE 2**. A summary of the PMP calculations have been included in **Appendix A**.

**TABLE 2: GSDM FACTORS FOR PMP ESTIMATE**

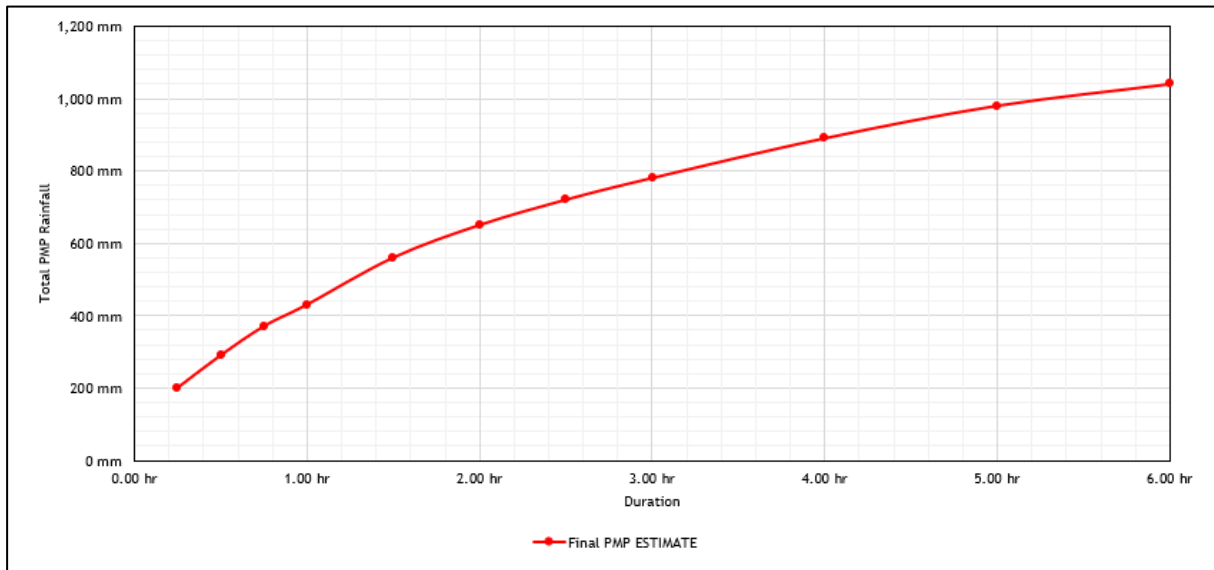
Parameter	Value
Duration Limit	0.25 - 6 hours
Proportion Smooth	0.0
Proportion Rough*	1.0
Mean elevation at site (m AHD)	210
Moisture Adjustment Factor (MAF)	0.9606

\*Rough terrain is classified as that in which elevation changes of 50 m or more within horizontal distances of 400 m are common [3].

These values were applied to generate the PMP envelope for 0.25 hours to 6 hours durations shown on **DIAGRAM 3** and summarised in **TABLE 3**.



**DIAGRAM 3: PMP RAINFALL DEPTH ESTIMATE**



**TABLE 3: PMP RAINFALL DEPTH ESTIMATE**

Duration (hr)	Rainfall Depth (mm)
0.25	200
0.5	290
0.75	370
1.0	430
1.5	560
2.0	650
2.5	720
3.0	780
4.0	890
5.0	980
6.0	1,040

The GSDM temporal pattern was applied to the rainfall depths in PMP rainfall estimates from **TABLE 3** to obtain a rainfall hyetograph. The hyetographs were applied as direct rainfall to the hydraulic model.

### 2.3 Rare Precipitation Estimation

Rainfall estimates for the centroids of the Dugald River and Cabbage Tree Creek upstream catchments were obtained from the Bureau of Meteorology's 'Design Rainfall Data System' [4]. Rainfall depths for the 1% and 0.1% AEP events are summarised in **TABLE 4**.



**TABLE 4: RARE RAINFALL DEPTH ESTIMATES**

Duration	Rainfall Depth (mm)	
	1% AEP	0.1% AEP
1 min	6.41	9.55
2 min	10.7	15.7
3 min	15.2	22.4
4 min	19.5	28.9
5 min	23.5	34.9
10 min	39.8	59.4
15 min	51.5	76.9
20 min	60.5	90.2
25 min	67.7	101
30 min	73.7	110
45 min	87.2	129
1 hour	96.9	144
1.5 hour	111	165
2 hour	122	181
3 hour	138	206
4.5 hour	157	236
6 hour	173	260
9 hour	200	301
12 hour	222	334
18 hour	260	390
24 hour	291	434
30 hour	318	464
36 hour	340	492
48 hour	378	542
72 hour	430	616
96 hour	463	664
120 hour	483	695
144 hour	494	713
168 hour	499	722

Rare events are defined as having an AEP equal to or greater than the 5% AEP event. Each event duration has an ensemble of ten different design temporal patterns (TP), as detailed in the Australian Rainfall and Runoff (ARR) Datahub [1]. The variations in the temporal patterns account for rainfall patterns not being uniform or the same for their duration, with periods of more intense and less intense rainfall occurring within a rainfall event. The ensemble temporal patterns have been designed to permit assessment of different rainfall patterns within a catchment. Rainfall estimates from **TABLE 4** were applied directly to the hydraulic model as rain on grid. This is discussed further in **Section 3.2**.



## 2.4 Regional Flood Frequency Estimate

To represent the risk of co-incident flooding from Cabbage Tree Creek and the Dugald River, flood discharge estimates were included in the model as upstream inflow boundary conditions in the TUFLOW hydraulic model. It was decided to adopt the flood discharge estimates of these catchments generated by the Regional Flood Frequency Estimator (RFFE) [2]. The RFFE utilises the data from 853 gauged catchments across Australia and utilises Log Pearson Type 3 distributions to estimate flows based on records in similar catchments.

The decision to use the RFFE data was made because first, it was considered that there would be very little impact from the rivers on the TSF or the DRM sites. This was tested by undertaking sensitivity tests on the discharge in the rivers. Secondly, the duration of the regional flood events in the Dugald River and Cabbage Tree Creek would be much longer than that in the tributaries from the TSF and the DRM so a steady state condition could be applied to the major creeks under the coincident flood event conditions as a conservative, but reasonable approach.

The resultant flow estimates for the Dugald River and Cabbage Tree Creek are summarised in **TABLE 5**.

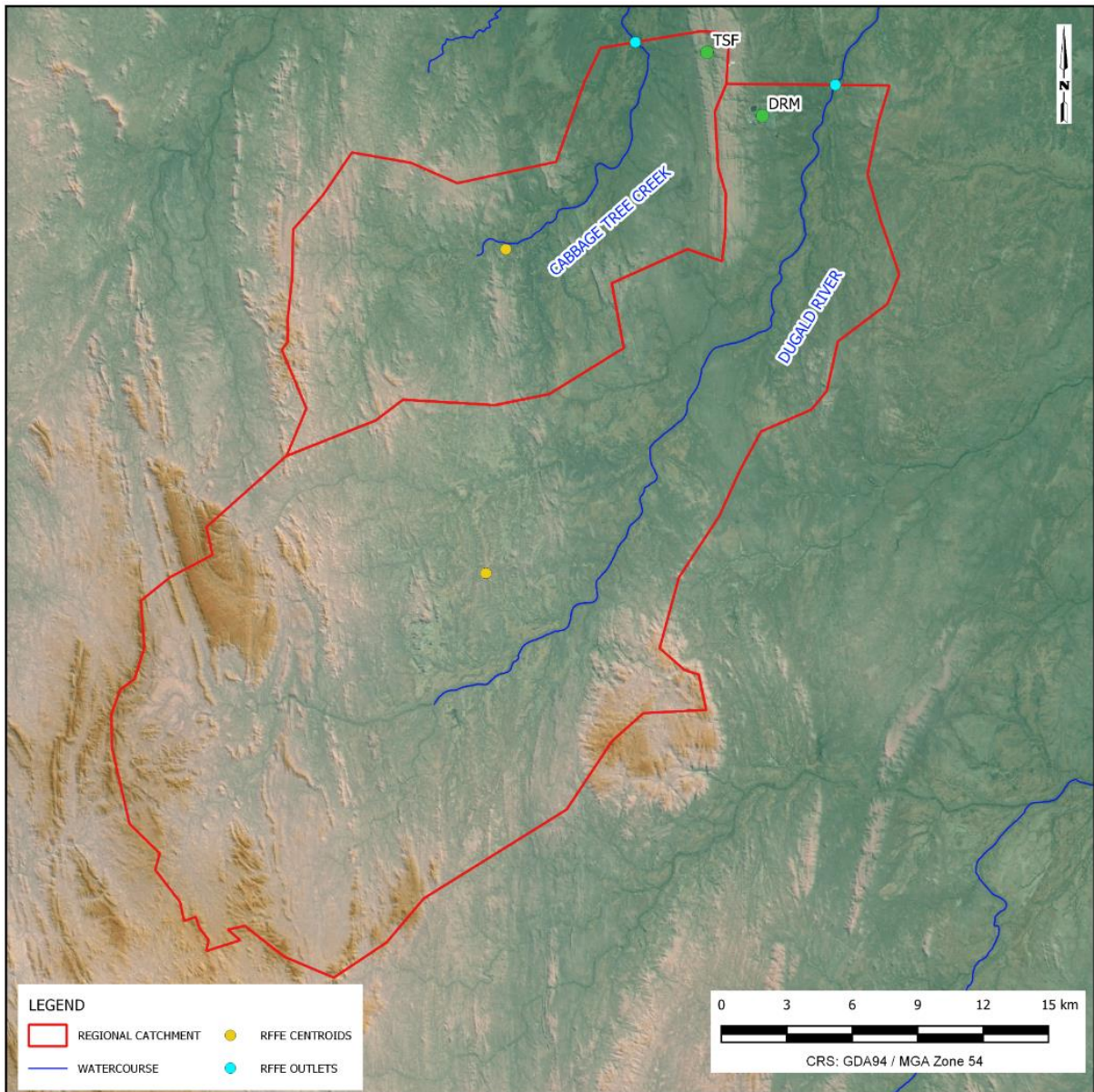
**TABLE 5: RFFE MEAN DISCHARGE SUMMARY**

AEP (%)	Dugald River (m <sup>3</sup> /s)	Cabbage Tree Creek (m <sup>3</sup> /s)
50	394	203
20	809	410
10	1,150	583
5	1,570	790
2	2,130	1,070
1	2,680	1,340

The catchment areas, outlet locations and centroid locations for the Dugald River and Cabbage Tree Creek were derived from Shuttle Radar Topographic Mission (SRTM) data [5]. This information is shown on **DIAGRAM 4**.



DIAGRAM 4: RFFE CATCHMENTS







### 3 HYDRAULIC ASSESSMENT

#### 3.1 Model Overview

Hydraulic analysis of the study area has been undertaken using the two dimensional (2D) finite difference program TUFLOW, which is an industry accepted software package highly suited to the investigation of flood behaviour in complex flow scenarios. The model can simulate unsteady hydrodynamic flow in two dimensions on a rectilinear grid, as well as a one-dimensional unsteady hydrodynamic flow through waterway structures such as culverts. The model is based on a robust finite difference solution scheme that is able to compute both sub-critical and supercritical flow regimes. The selected hydraulic solver for the 2D model was the HPC scheme.

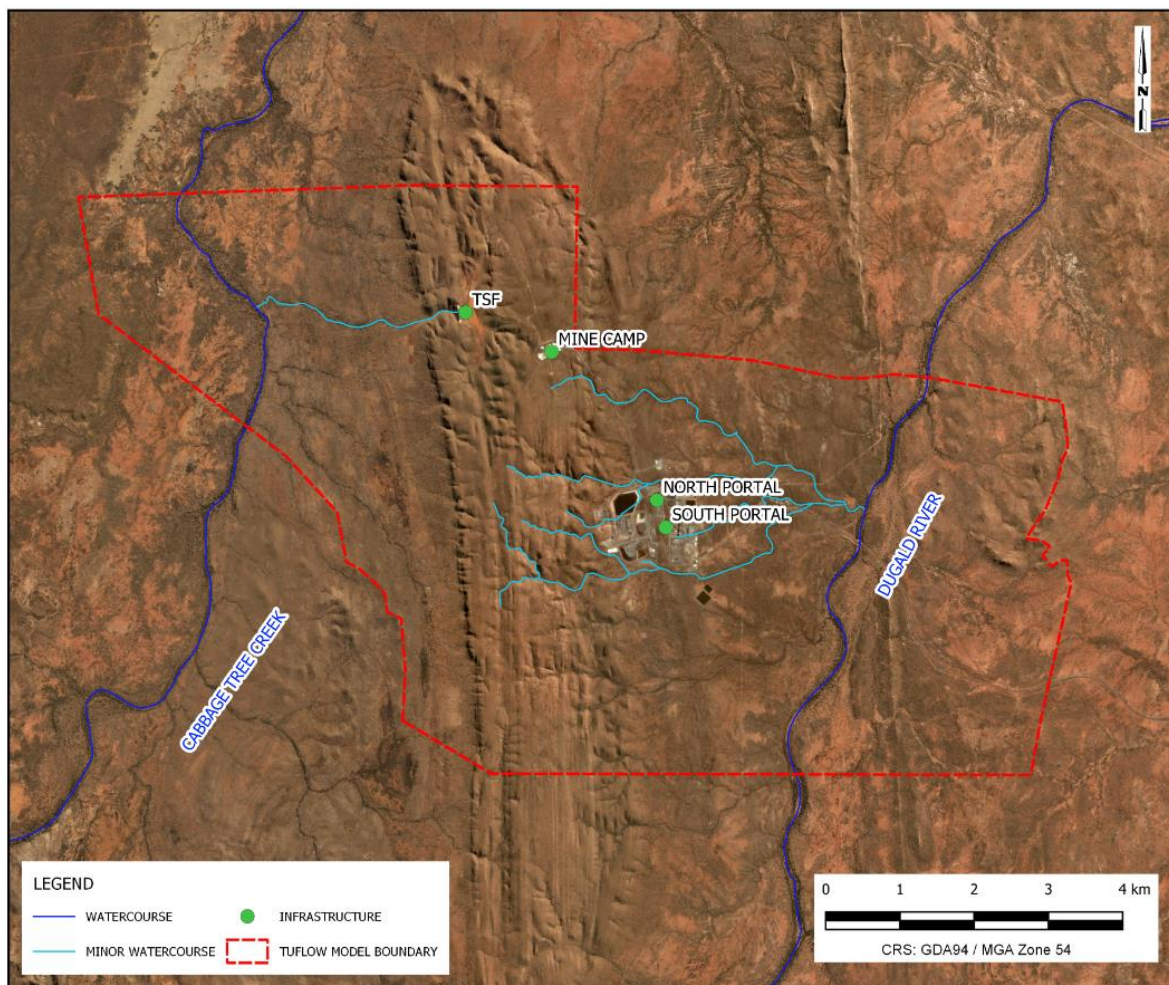
#### 3.2 Model Domain, Grid Size and Time Step

##### 3.2.1 Domain

The 2D TUFLOW model was set up to quantify the impacts of the PMP, 0.1% AEP and 1% AEP design storm events. The model domain is depicted on **DIAGRAM 5** and includes the following structures and areas:

- TSF (Post closure surface and spillway)
- North Portal
- South Portal

**DIAGRAM 5: TUFLOW MODEL DOMAIN**







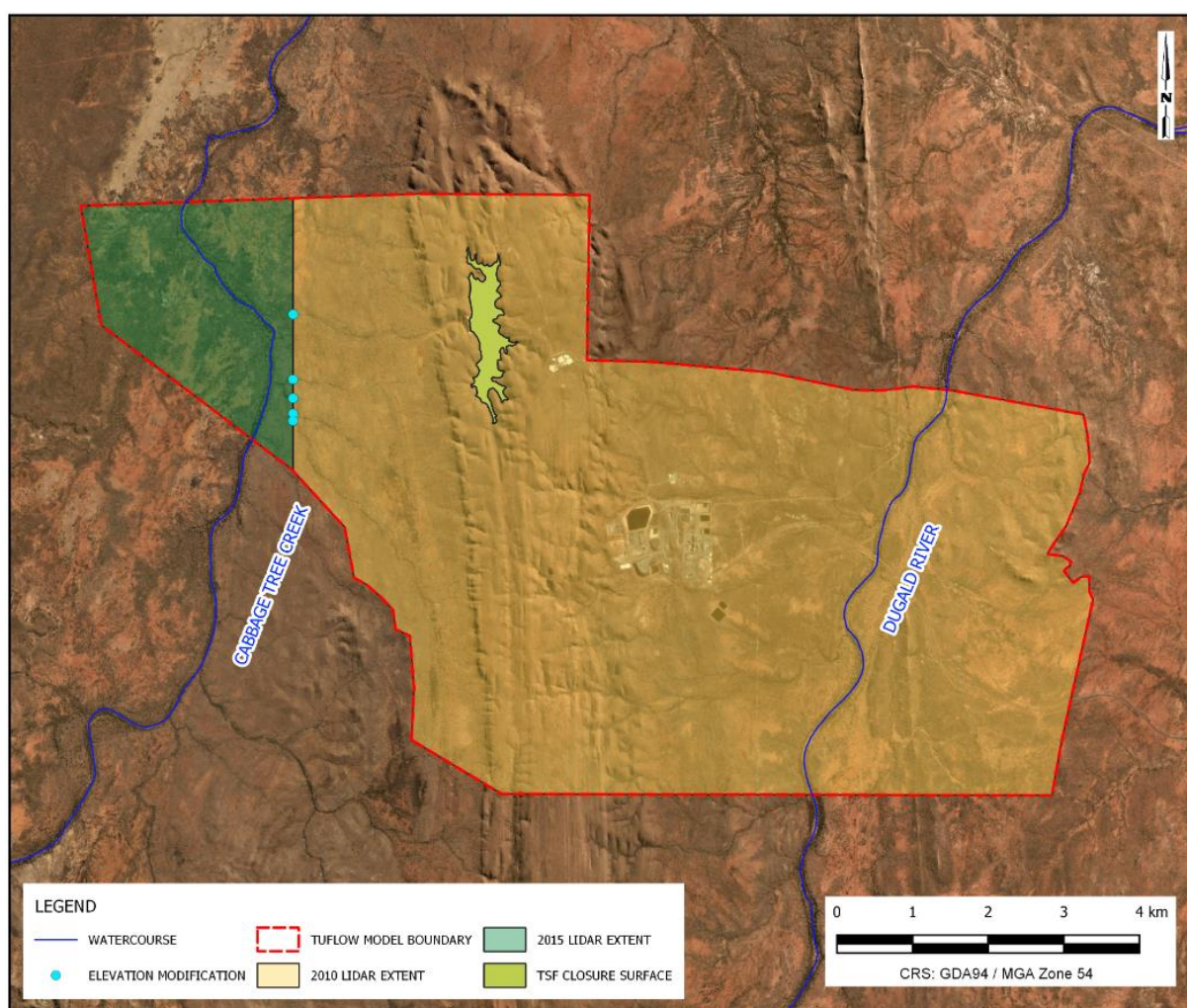
### 3.2.2 Topography

The TUFLOW model development was based on a 5m x 5m gridded elevation raster model, resampled from site LIDAR survey provided by MMG, to form a base topography. The LIDAR survey files provided by MMG including the following:

- Site Lidar – 2010 [6]
- Site Lidar – 2015 [7]

It is understood that MMG intend to rehabilitate the main mine site and camp to the pre-mining topography as much as is practically possible. As such, the MMG provided 2010 Site LIDAR was used as the base topographic input, supplemented on the western extent by the 2015 Site LIDAR (refer **DIAGRAM 6**). The TSF is to remain, with a capping layer added, so a TSF closure surface and spillway were incorporated within the topography, with details provided in **Sections 3.2.3** and **3.2.4**, respectively. The survey elevations were modified by smoothing in the TUFLOW model at the intersection of the surveys to ensure free flowing drainage through the drainage features where there were differences in level between the two data sets. These points are shown by the blue dots on **DIAGRAM 6**.

**DIAGRAM 6: TOPOGRAPHICAL INPUTS**





### 3.2.3 TSF Closure Surface

In 2016, ATC Williams undertook the design of the TSF [8]. This design included a concept closure plan and surface of the TSF [9]. The cover system is proposed to be self-shedding, with a nominal gradient of 1.5%. The embankment will be modified with a 1:5 (V:H) grade at the crest of the embankment, transiting to 1:8 (V:H) at the base, where it then joins natural surface. The closure plan is included in **Appendix B**. This proposed closure surface has been incorporated within the hydraulic model.

Further work on the design of the closure cover system was undertaken by SGM Environmental in 2019, consisting of column trials and a semi-calibrated model, which indicated that the TSF cover will likely require a 1.0 m thick infiltration storage layer (ISL) to reduce the potential for seepage into the tailings [10]. Run-of-mine NAF waste rock blends will be used in the TSF final cover to protect against surface erosion of the ISL. The final cover will be reshaped for effective drainage to the nominal 1.5% gradient. Although the cover system will store some rainfall runoff, the hydraulic assessment has assumed a self-shedding cover (refer **Section 3.4**).

### 3.2.4 TSF Closure Spillway

During the design of the TSF, it was envisaged that two (2) closure spillways would be constructed to convey flows up to and including the Probable Maximum Flood. Based on preliminary modelling results, it is proposed to construct a single spillway with the details provided in **TABLE 6**.

**TABLE 6: TSF CLOSURE SPILLWAY DETAILS**

Parameter	Value
Upstream Invert Level	235.0 m AHD
Downstream Invert Level	228.3 m AHD
Base Width	30.0 m
Side Slopes	1: 2 (V:H)
Length	330 m
Longitudinal Grade	2.0 %

### 3.2.5 Grid Size and Time Step

A 5 m x 5 m grid was applied to the digital terrain model. Direct rainfall was applied to the grid with an initial timestep of 2.5 seconds. To ensure the maximum impacts of the proposed development were captured in the model, a lag time of approximately 3 hours was applied to the direct rainfall to allow for the RFFE flows in the Dugald River and Cabbage Tree Creek to reach the TSF and DRM areas before rainfall was applied to the study areas. The adopted simulation times are summarised in

**TABLE 7.**

**TABLE 7: HYDRAULIC MODEL SIMULATION TIME**

Event Duration	Simulation Time (hr)
20 min	4.0
25 min	4.0
45 min	4.0
1 hour	4.5
1.5 hour	5.0
2 hour	5.5
3 hour	6.5



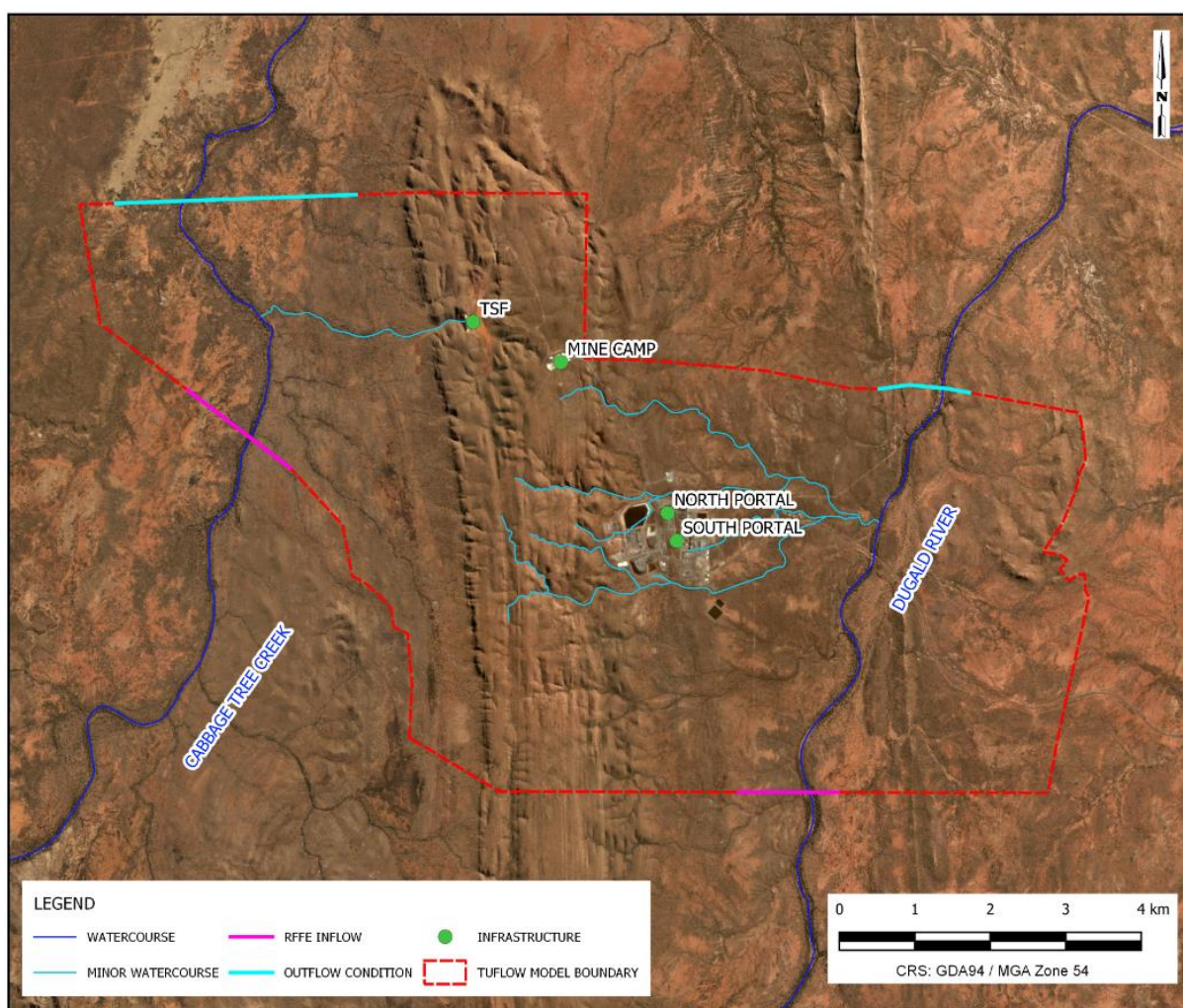


Event Duration	Simulation Time (hr)
4.5 hour	8.0
6 hour	8.5
9 hour	13.0
12 hour	16.0

### 3.3 Boundary Conditions

As detailed in **Section 2.4**, RFFE flows for the Dugald River and Cabbage Tree Creek were applied to the upstream inflow boundaries in the model domain. The location of upstream inflows are depicted by pink lines on **DIAGRAM 7** and are detailed in **TABLE 8**.

**DIAGRAM 7: BOUNDARY LOCATIONS**





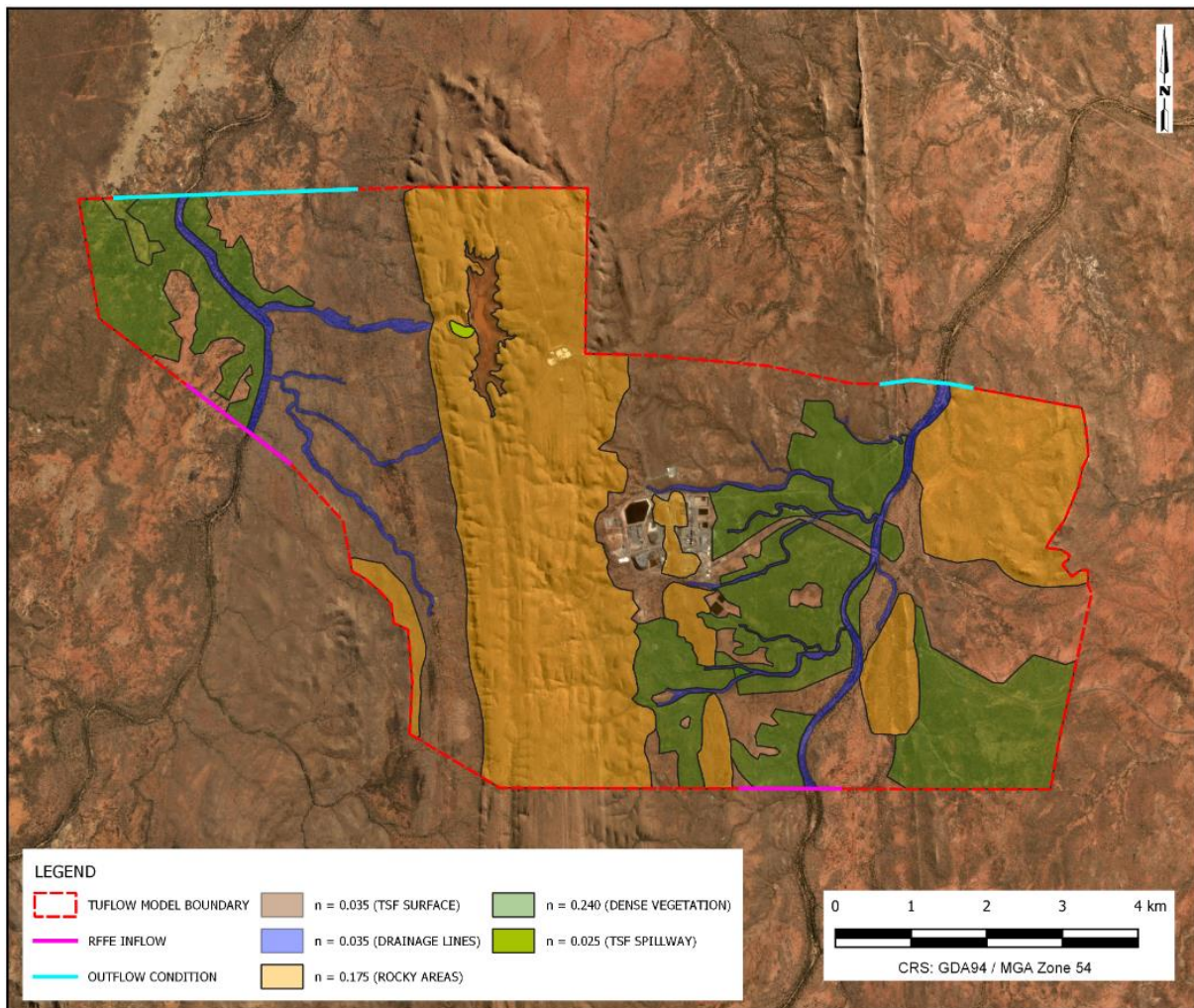
**TABLE 8: BOUNDARY CONDITIONS**

Site Rainfall Event	RFFE Event	Dugald River (m <sup>3</sup> /s)	Cabbage Tree Creek (m <sup>3</sup> /s)
PMP	1 % AEP Mean Flow	2,680	1,340
0.1 % AEP	1 % AEP Mean Flow	2,680	1,340
0.1 % AEP Sensitivity	1% AEP 95 <sup>th</sup> Percentile Flow	11,500	5,540
1 % AEP	5% AEP Mean Flow	1,570	790

### 3.4 Surface Roughness

The Manning's 'n' surface roughness coefficient is used to describe the surface conditions within the model domain. Manning's roughness coefficients were assigned to the model domain, as depicted on **DIAGRAM 8**. Selection of the coefficient was made considering the apparent roughness of surfaces based upon inspection of available aerial imagery. The default surface roughness of 0.13 was adopted to represent the areas of bare earth and sparse vegetation.

**DIAGRAM 8: MANNINGS ROUGHNESS**







Reference values from Innovyze (2019) [11] were adopted for the following surfaces. Innovyze are the developers of a range of hydraulic and hydrology software with a comprehensive online resource library.

- Natural flow and deep flow within the drainage features – adopted a roughness of 0.035 representing streams on a plain; clean, winding, some pools and shoals, and major streams; tranquil flow with dunes.
- TSF surface – adopted a roughness of 0.035 representing a finished surface that sheds water,
- TSF spillway channel – adopted a roughness of 0.025 representing a straight unlined channel,
- Dense vegetation – adopted a roughness of 0.240 representing dense vegetation,
- Rocky elevated surfaces – adopted a roughness of 0.175.

### 3.5 Sensitivity Analysis

As discussed in previous sections of the report, there are aspects of the hydraulic modelling that have been assumed or estimated. Sensitivity analyses were undertaken to accommodate for uncertainties adopted in the approach. The following considerations were adopted as part of the sensitivity analyses:

- 1.0% AEP 95<sup>th</sup> percentile RFFE inflows – takes into account the uncertainty in the hydrological inputs from the RFFE (refer **TABLE 8**).
- A 20% increase in rainfall depths – takes into account the uncertainty with more extreme rainfall events due to climate change.
- Assigning a 20% increase in Manning's roughness coefficients. Higher roughness coefficients reduce the flow velocity and consequently increase the modelled flow depths.

Initially, a 10 m x 10 m grid size was selected, but it did not provide sufficient model refinement in the TSF spillway. A 5 m x 5 m grid size gave better model resolution and so was adopted for all scenarios. The 2015 site LIDAR topography [6], used on the western extent of the model, was provided with a cell size of 5 m, so the accuracy of the modelled surface matched that of the data provided.



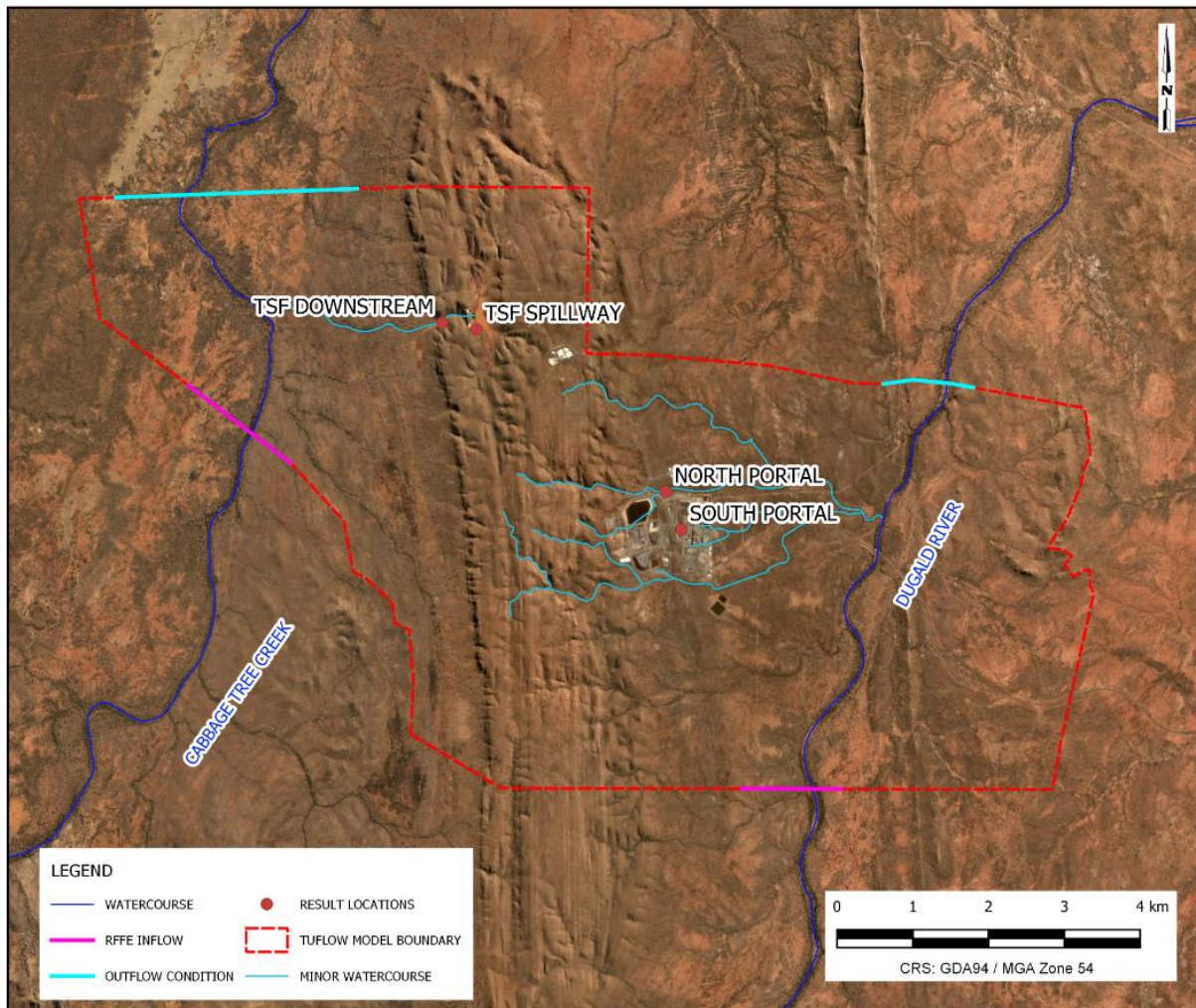
## 4 RESULTS AND IMPACTS

### 4.1 General

The results of the TUFLOW model showing maximum water depths and velocities are presented in **Figure 001** to **Figure 012**.

A summary of impacts on the TSF, North Portal, South Portal, and the tributaries downstream of the sites are summarised below. The key locations at which results are derived are outlined on **DIAGRAM 9**.

**DIAGRAM 9: PEAK FLOOD LEVEL LOCATIONS**





## 4.2 TSF

The maximum recorded flow immediately downstream of the TSF, as well as the storm duration and temporal pattern producing the peak flow are summarised in **TABLE 9**. The impacts on the TSF Spillway are summarised in **TABLE 10**. It is noted that upon closure, with only a single spillway, the embankment crest should be raised to a level of 238.5 m AHD.

**TABLE 9: TSF PEAK FLOWS**

	PMP	0.1% AEP	1% AEP
Peak Flow m <sup>3</sup> /s	282.9	74.6	44.6
Critical Storm Duration and Temporal Pattern	90 min	540 min TP10	540 min TP10

**TABLE 10: TSF SPILLWAY IMPACTS**

	PMP	0.1% AEP	1% AEP
TSF Embankment Levels (m AHD)	238.0	238.0	238.0
Upstream Spillway Elevation (m AHD)	235.0	235.0	235.0
Upstream Maximum Surface Elevation (m AHD)	237.59	236.00	235.67
Upstream Maximum Flow Depth (m)	2.59	1.0	0.67
Upstream Spillway Flow Velocity (m/s)	4.2	2.9	2.5
Downstream Spillway Elevation (m AHD)	228.3	228.3	228.3
Downstream Maximum Surface Elevation (m AHD)	230.0	229.12	228.92
Downstream Maximum Flow Depth (m)	1.70	0.82	0.62
Downstream Spillway Flow Velocity (m/s)	6.2	4.1	3.5
Peak Spillway Flow (m <sup>3</sup> /s)	274.1	72.4	43.7

Modelled results for the TSF indicate that for the PMP event a backwater effect was present at the downstream toe of the TSF closure embankment. The flow down the spillway is confined by the downstream channel and some of the spillway discharge is forced upstream to the TSF closure embankment. The modelled maximum depth at the toe of the TSF closure embankment was some 3.7 m. This backwater effect could be limited by re-alignment of the spillway channel during the detailed design process, to allow for greater alignment with the downstream flow path. Furthermore, maximum velocities recorded for the PMP event were some 6.2 m/s within the spillway channel. These modelled velocities have a high potential for erosion, and as such erosional velocity dampeners or a similar method of limiting velocity through the spillway channel would potentially need to be implemented. These issues will require further examination during detailed design of the closure spillway.

## 4.3 Portals and Tributaries

The maximum recorded water surface elevations immediately adjacent to the North Portal (recorded in North Creek) are summarised in **TABLE 11**. Maximum recorded water surface elevations immediately adjacent to the South Portal (recorded in Mine Trib Centre) are summarised in **TABLE 12**. The locations where water surface elevations are recorded are depicted on **DIAGRAM 9**.





**TABLE 11: NORTH PORTAL IMPACTS**

	<b>PMP</b>	<b>0.1% AEP</b>	<b>1% AEP</b>
Portal Crest Level at top of ramp (m AHD)	207.5	207.5	207.5
Maximum Water Surface Elevation (m AHD)	204.00	201.77	201.45
Depth of water impacting portal (m)	-	-	-
Freeboard to portal crest level (m)	3.50	5.73	6.05

As can be seen in **TABLE 11**, the North Portal is not subject to inundation in any events up to and including the PMF, and as such is not considered to be in the floodplain.

**TABLE 12: SOUTH PORTAL IMPACTS**

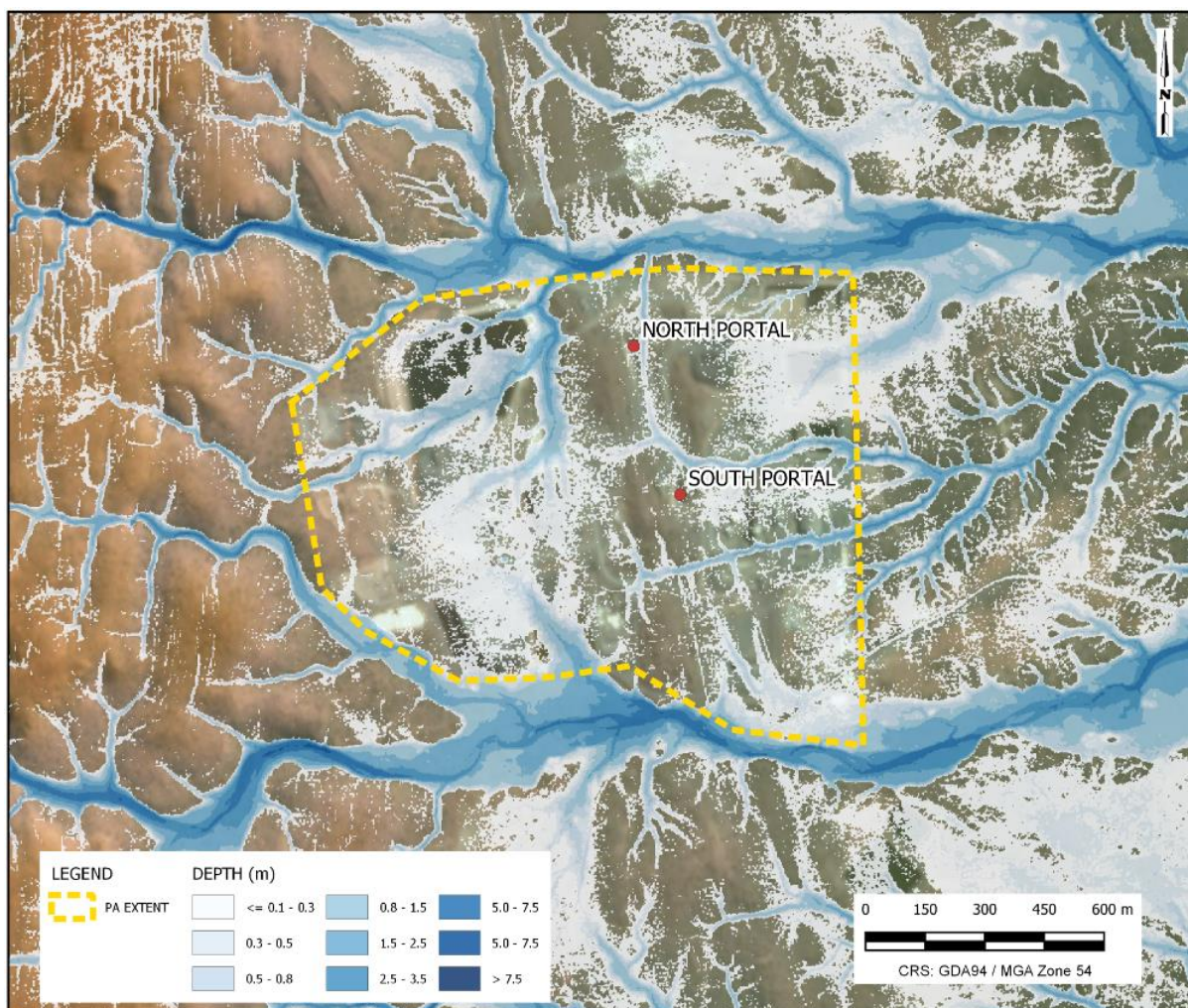
	<b>PMP</b>	<b>0.1% AEP</b>	<b>1% AEP</b>
Portal Crest Level at top of ramp (m AHD)	206.0	206.0	206.0
Maximum Water Surface Elevation (m AHD)	205.50	204.84	204.74
Depth of water impacting portal (m)	-	-	-
Freeboard to portal crest level (m)	0.50	1.16	1.26

**TABLE 12** shows the South Portal is not subject to inundation in any events up to and including the PMF, and as such is not considered to be in the floodplain.

The modelled results indicate that the mine portals are clear of local flooding and are outside the floodplain. Notwithstanding, there are small drainage lines in the area which are depicted on **DIAGRAM 10**. These drainage lines are artefacts of the original topography prior to any mine disturbance and not a definitive representation of the final landform. Local topography and drainage will be modified during closure, to ensure that local runoff is directed away from the portals and will aim to reconnect drainage lines with downstream watercourses.



**DIAGRAM 10: PROCESS AREA - PMP FLOOD DEPTH**



The maximum recorded water surface elevation and maximum velocities in North Creek, Mine Trib Centre and Silvermine Creek downstream of the Process Area are summarised in **TABLE 13** and **TABLE 14**. The locations where results are recorded in **TABLE 13** and **TABLE 14** are depicted on **DIAGRAM 11**.

**TABLE 13: PROCESS AREA TRIBUTARY PEAK WATER SURFACE ELEVATIONS**

Location	Peak Water Surface Elevation (m AHD)		
	PMP	0.1% AEP	1% AEP
North Creek	197.48	195.43	195.19
North Creek DS	191.65	191.63	191.62
Mine Trib Centre	198.33	197.14	196.86
Mine Trib Centre DS	189.95	188.28	188.00
Silvermine Creek	200.97	198.91	198.57
Silvermine Creek DS	193.29	191.05	190.74

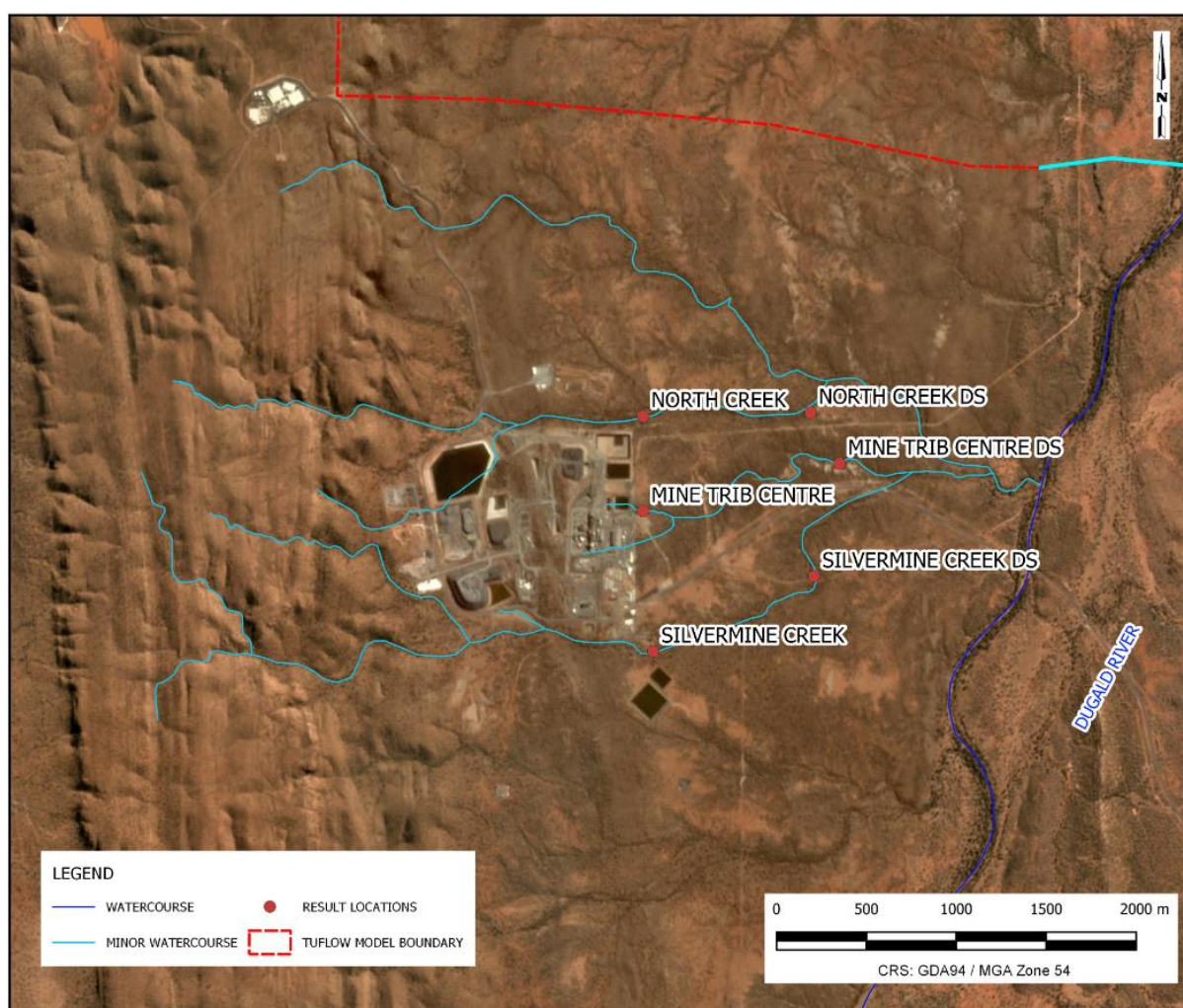




**TABLE 14: PROCESS AREA TRIBUTARY MAXIMUM VELOCITIES**

Location	Maximum Velocity (m/sec)		
	PMP	0.1% AEP	1% AEP
North Creek	3.15	2.74	2.46
North Creek DS	3.14	2.46	2.27
Mine Trib Centre	0.79	0.50	0.43
Mine Trib Centre DS	0.41	0.37	0.31
Silvermine Creek	2.51	1.90	1.83
Silvermine Creek DS	2.07	1.97	1.95

**DIAGRAM 11: PROCESS AREA FLOOD LEVEL LOCATIONS**





#### 4.4 Sensitivity Outcomes

The sensitivity analysis was conducted for the conditions listed in **Section 3.5**. The results for the 1.0% AEP 95<sup>th</sup> percentiles RFFE inflows indicated no impacts on the TSF closure embankment and spillway from flows in Cabbage Tree Creek, and no impacts on the plant process area from flows in the Dugald River. Under the modelled scenario a backwater effect from the increased sensitivity inflow does not impact the model.

Relative to the base model, a 20% increase in Manning's roughness coefficient does not have a significant impact on the maximum water surface elevations at the North Portal and has a slight negative impact at the South Portal. A 20% increase in the applied rainfall depth results in an increase in flows depths up to 0.36 m adjacent to the North Portal and 0.15 m at the South Portal. A comparison of base model and sensitivity test results is shown in **TABLE 15**.

**TABLE 15: PORTAL SENSITIVITY IMPACTS**

Location	Model Type	Maximum Water Surface Elevation (m AHD)		
		PMP	0.1% AEP	1% AEP
North Portal	Base Model	204.00	201.77	201.45
	+ 20% Manning's Sensitivity	204.04	201.79	201.46
	+ 20% Rainfall Depth	204.36	201.98	201.60
	<b>Maximum Modelled Difference</b>	+ 0.36 m	+ 0.21 m	+ 0.15 m
South Portal	Base Model	205.50	204.84	204.74
	+ 20% Manning's Sensitivity	205.35	204.77	204.75
	+ 20% Rainfall Depth	205.65	204.90	204.79
	<b>Maximum Modelled Difference</b>	+ 0.15 m	+ 0.06 m	+ 0.05 m

Relative to the base model, an increase of 20% in Manning's roughness coefficient has no significant impact on the water surface elevation of the model in all events up to the PMF. An increase of 20% rainfall depth results in an increase in water surface elevation of up to 0.27 m in the TSF spillway. Increasing the surface roughness decreases the peak flow rate because surface flows are retarded upstream of the spillway, as reflected in **TABLE 17**. Conversely, increasing rainfall depths by 20% had the result of increasing peak flow rate by between 18% and 27% for the PMP and 1% AEP events, respectively. Comparisons of base model results and sensitivity test results are shown in **TABLE 16** and **TABLE 17**.

**TABLE 16: TSF SPILLWAY IMPACTS – MAXIMUM DEPTH**

Location	Model Type	Maximum Water Surface Elevation (m AHD)		
		PMP	0.1% AEP	1% AEP
TSF Spillway - Upstream	Base Model	237.59	236.00	235.67
	+ 20% Manning's Sensitivity	237.51	235.94	235.68
	+ 20% Rainfall Depth	237.85	236.14	235.78
	<b>Maximum Modelled Difference</b>	+ 0.26 m	+ 0.14 m	+ 0.11 m
TSF Spillway - Downstream	Base Model	230.00	229.12	228.92
	+ 20% Manning's Sensitivity	229.98	229.09	228.67
	+ 20% Rainfall Depth	230.27	229.26	229.04
	<b>Maximum Modelled Difference</b>	+ 0.27 m	+ 0.14 m	+ 0.12 m



**TABLE 17: TSF SPILLWAY IMPACTS – MAXIMUM FLOW RATE**

Location	Model Type	Peak Flow Rate (m <sup>3</sup> /sec)		
		PMP	0.1% AEP	1% AEP
TSF Spillway	Base Model	282.9	74.6	44.6
	+ 20% Manning's Sensitivity	246.0	71.1	43.7
	+ 20% Rainfall Depth	333.5	89.3	56.5
	<b>Maximum Modelled Difference</b>	+ 50.6	+ 14.7	+ 11.9

The sensitivity tests indicate that the model is not very sensitive to increases in the surface roughness, but has some sensitivity to increases in rainfall depths at both the main mine site and the TSF area.



## 5 PCRP INPUTS

The PCRP requires flood risk assessments for two aspects of closure; to identify whether any mine voids will remain in the floodplain post-closure, and to assess the flood risk to any remaining infrastructure.

### 5.1 Mine Portals

Post closure, if there was a mine void located in a floodplain the void would need to be rehabilitated to a stable condition. A mine portal could potentially be considered as a void, and the floodplain is defined as land which is at or below the peak water level for the 0.1% AEP design storm event.

The modelling outputs presented in **Section 4** show that the mine portals are not located below the 0.1% AEP flood level and are therefore not located within the floodplain. Further, both portals are at very low risk from flooding. The North Portal and the South Portal are not subject to inundation in any events up to and including the PMF.

Flood mapping shows that the portals are clear of local flooding and are outside of the floodplain, but there are small drainage lines in the area. These drainage lines are artefacts of the original topography prior to any mine disturbance and not a definitive representation of the final landform (refer **DIAGRAM 10**). Local topography and drainage will be modified during closure, to ensure that local runoff is directed away from the portals and will aim to reconnect drainage lines with downstream watercourses.

It should also be noted that the mine portals will be capped at closure, to prevent water entering the mine workings.

### 5.2 TSF

Post closure, the TSF will be the only remaining piece of infrastructure, although this will be closed and capped. Preliminary design has adopted a self-shedding cover system, with a nominal gradient of 1.5%, and a modified embankment. A spillway channel will be added, to achieve the following:

- Prevent water from ponding against the upstream face of the embankment;
- Prevent flow over the top of the embankment;
- Divert flows away from the toe of the embankment; and
- Reconnect catchment flows with the downstream watercourse.

The flood modelling presented in **Section 4** has demonstrated that the proposed spillway design (**TABLE 6**) is suitable to safely convey design events up to and including the PMF. Flooding from the downstream tributary and Cabbage Tree Creek does not affect the TSF embankment. Notwithstanding, modelled results indicated that a backwater effect was exhibited on the downstream toe of the TSF embankment, as a result of the spillway outflows. Re-alignment of the spillway channel, to properly convey catchment flows to the downstream tributary, will be required during detailed design of the spillway.





## 6 SUMMARY AND CONCLUSION

Hydraulic analysis of the site was undertaken using the two dimensional (2D) finite difference program TUFLOW, with ARR [1] utilised to develop the rainfall estimates for input into the hydraulic model. It is understood that MMG intends to rehabilitate the site to the pre-mining topography, as much as is practically possible. As such, the pre-mining surface and the preliminary TSF closure plan, developed by ATCW in 2016, were incorporated in the hydraulic model.

The PRCP requires flood risk assessments for two aspects of closure: to identify whether any mine voids will remain in the floodplain post-closure; and to assess the flood risk to remaining infrastructure. The modelling outputs presented in **Section 4.3** show that the mine portals are not located below the 0.1% AEP flood level and are therefore not within the floodplain. Additionally, the modelling results indicated that both portals are at a low risk of flooding. The North Portal and the South Portal are not subject to inundation in any events up to and including the PMF.

The remaining infrastructure proposed to be left at the site is the rehabilitated and capped TSF. Modelled results indicate that flooding from the downstream tributary and Cabbage Tree Creek does not affect the TSF embankment. Notwithstanding, a backwater effect was exhibited on the downstream toe of the TSF embankment, due to the spillway outflows. Re-alignment of the spillway channel, to properly convey catchment flows to the downstream tributary, will be required during detailed design of the spillway. Modelling results indicated that, with only a single spillway, the TSF embankment crest should be raised to a level of 238.5 m AHD. Additionally, the maximum velocities recorded for the PMP event were some 6.2 m/s within the spillway channel. These modelled velocities have a high potential for erosion, and as such erosional velocity dampeners, re-grading of the spillway channel or a similar method of limiting velocity would potentially need to be implemented.



## REFERENCES

- [1] Ball J, Babister M, Nathan R, Weeks W, Weinmann E, Retallick M, Testoni I, (Editors), 2019, Australian Rainfall and Runoff: A Guide to Flood Estimation, Commonwealth of Australia
- [2] Rahmen A, Haddad, K (2021), 'Regional Flood Frequency Estimation Model,' Accessed 15 April 2021, <https://rffe.arr-software.org/> .
- [3] Bureau of Meteorology (2003), 'The Estimation of Probable Maximum Precipitation in Australia: Generalised Short-Duration Method', Bureau of Meteorology, Melbourne, Australia, June 2003
- [4] Bureau of Meteorology (2019), 'Design Rainfall Data System', Commonwealth of Australia.
- [5] Geoscience Australia (2021), 'Shuttle Radar Topographic Mission – Hydro\_Enforced\_1\_second\_DEM', Accessed 09 April 2021, <https://elevation.fsdf.org.au/> .
- [6] MMG Australia Pty Ltd (2010), 'Site Lidar – 2010', DRR\_2m\_DEM\_LIDAR\_2010.
- [7] MMG Australia Pty Ltd (2015), 'Site Lidar – 2015', IDW\_5m\_30.10.15.
- [8] ATCW (2016a), 'MMG Dugald River – Tailings Storage Facility - Design Report' (Ref: 108003.18.R03 – dated 25 May 2016).
- [9] ATCW (2016b), 'MMG Dugald River – Tailings Storage Facility - Design Report Closure Concept – Figure 15.1' (Ref: 108003.20.Figure 15.1 – dated 22 February 2016).
- [10] SGM Environmental Pty Ltd (2019), 'Tailings Storage Facility: Dugald River Mine: Column Cover trials, prepared for MMG limited.
- [11] Innovyze (2019), 'Manning's n Roughness Coefficients – Open Channel', October 2019.



## CONDITIONS OF REPORT

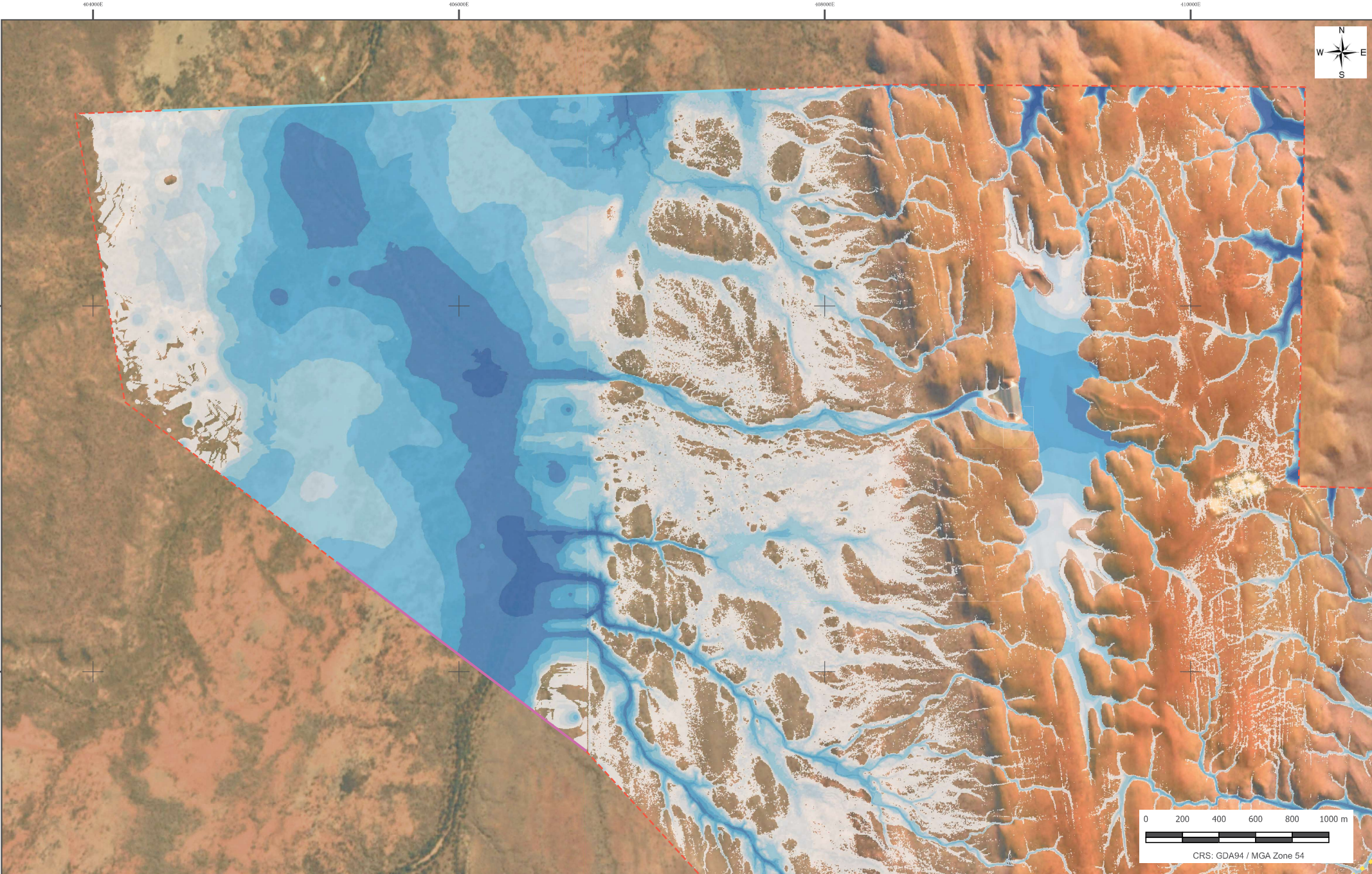
1. This report must be read in its entirety.
2. This report has been prepared by ATCW for the purposes stated herein and ATCW's experience, having regard to assumptions that can reasonably be expected to make in accordance with sound professional principles. ATCW does not accept responsibility for the consequences of extrapolation, extension or transference of the findings and recommendations of this report to different sites, cases, or conditions.
3. This document has been prepared based in part on information which was provided to ATCW by the client and/or others and which is not under our control. ATCW does not warrant or guarantee the accuracy of this information. The user of the document is cautioned that fundamental input assumptions upon which the document is based may change with time. It is the user's responsibility to ensure that these assumptions are valid.
4. Unless specifically agreed otherwise in the contract of engagement, ATCW retains Intellectual Property Rights over the contents of the document. The client is granted a licence to use the report for the purposes for which it was commissioned.



---

## FIGURES





**LEGEND**

- OUTFLOW BOUNDARY
- INFLOW BOUNDARY
- TUFLOW MODEL BOUNDARY

**ELEVATION (RL m)**

- 170
- 275
- 205
- 310
- 240

**MAXIMUM DEPTH (m)**

- 0.3 - 0.5
- 1.5 - 2.5
- 5.0 - 7.5
- 0.5 - 0.8
- 2.5 - 3.5
- > 7.5
- 0.8 - 1.5
- 5.0 - 7.5

MMG AUSTRALIA PTY LTD

DUGALD RIVER MINE  
TSF PMP - MAXIMUM FLOOD DEPTH

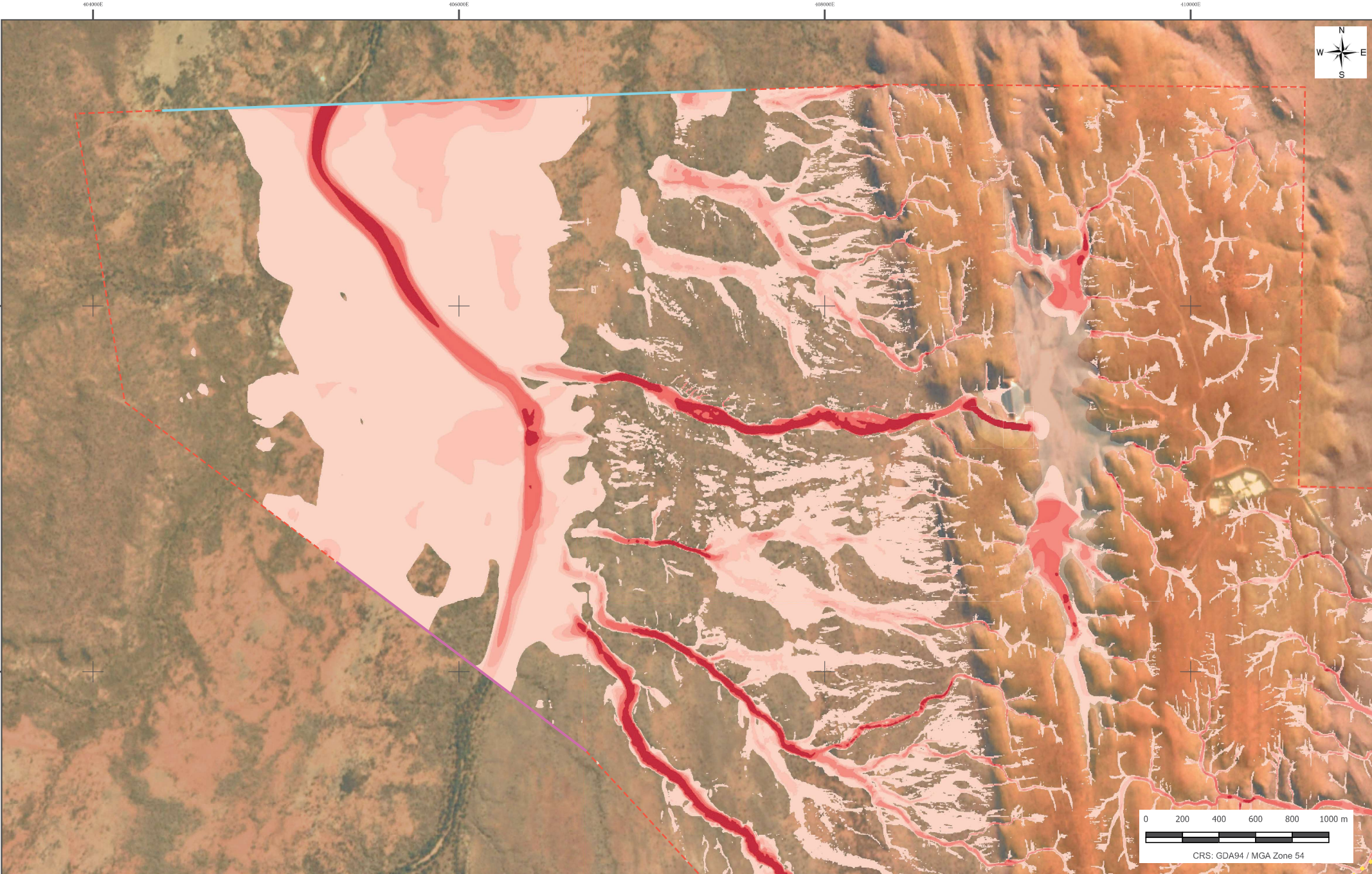


**FIGURE 001**

108003-49

DATE: 2021-05-18





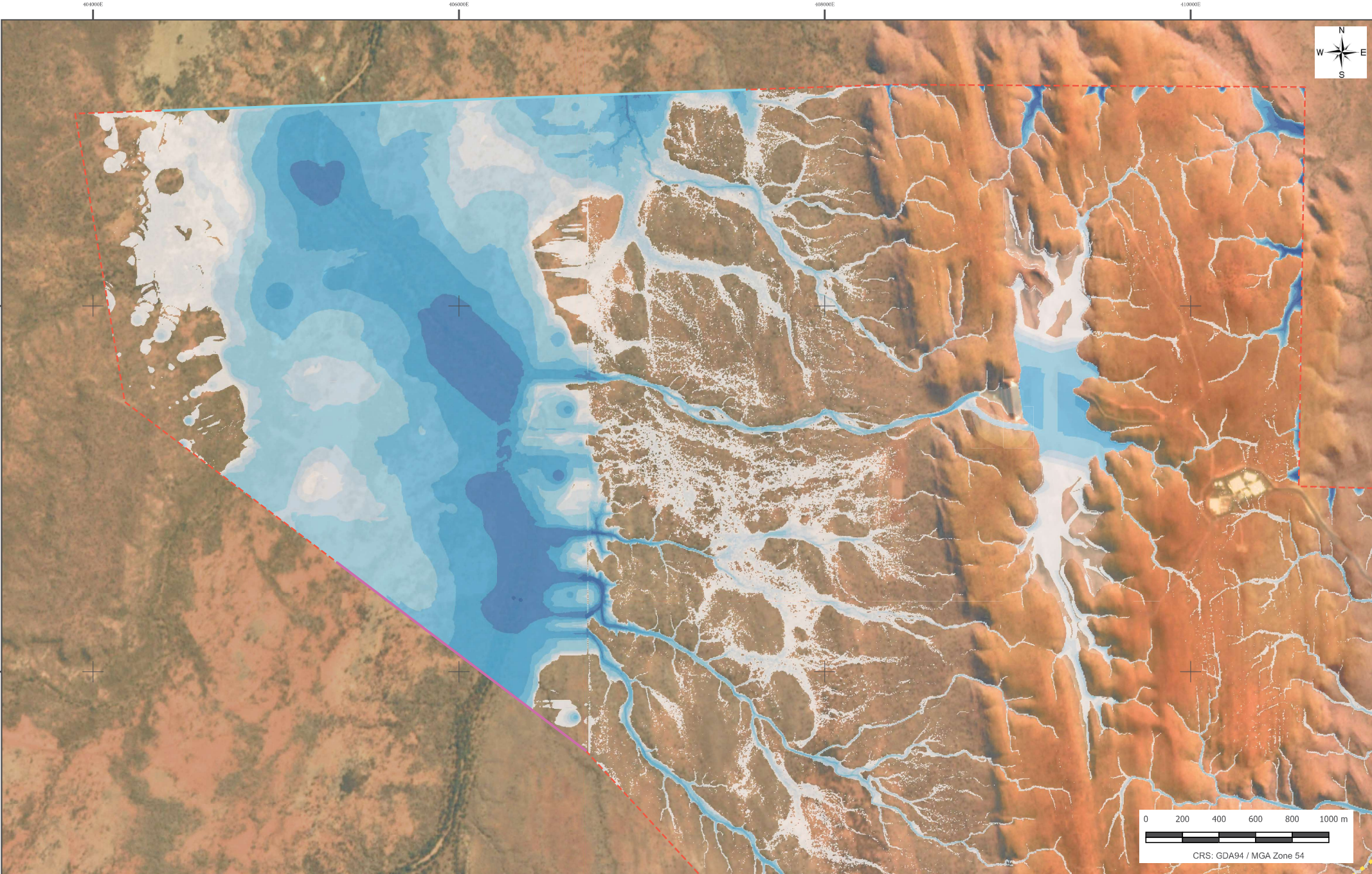
LEGEND	ELEVATION (RL m)	MAXIMUM VELOCITY (m/sec)		
OUTFLOW BOUNDARY	170	0.3 - 0.6	0.8 - 1.0	> 2.5
INFLOW BOUNDARY	205	0.6 - 0.8	1.0 - 1.5	
TUFLOW MODEL BOUNDARY	240	0.6 - 0.8	1.5 - 2.5	

MMG AUSTRALIA PTY LTD  
 DUGALD RIVER MINE  
 TSF PMP - MAXIMUM FLOOD VELOCITY



**FIGURE 002**  
 108003-49  
 DATE: 2021-05-18





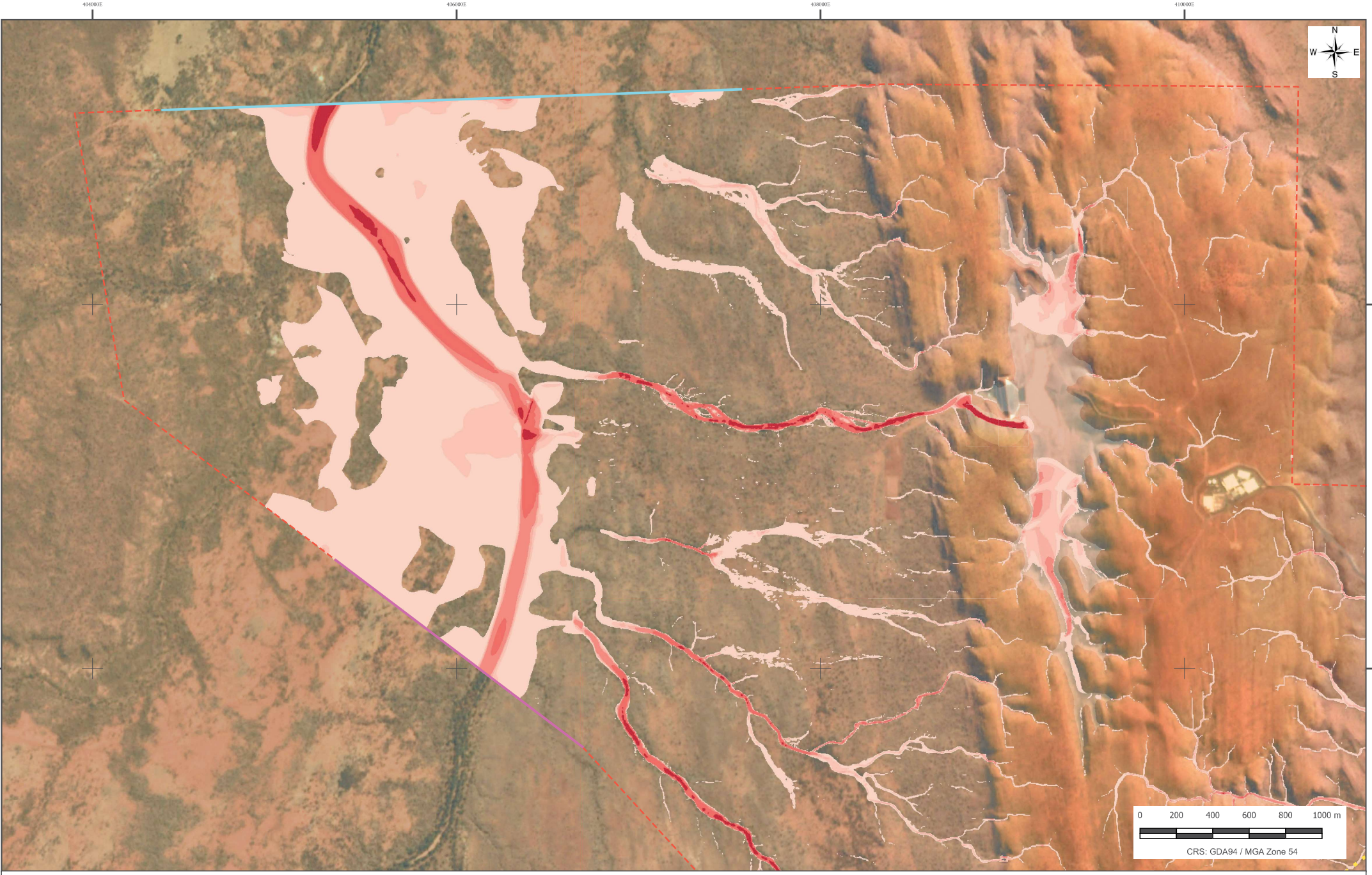
LEGEND	ELEVATION (RL m)	MAXIMUM DEPTH (m)
OUTFLOW BOUNDARY	170	0.3 - 0.5
INFLOW BOUNDARY	275	1.5 - 2.5
TUFLOW MODEL BOUNDARY	205	5.0 - 7.5
	310	> 7.5
	240	0.5 - 0.8
		2.5 - 3.5
		5.0 - 7.5

MMG AUSTRALIA PTY LTD  
 DUGALD RIVER MINE  
 TSF 0.1% AEP - MAXIMUM FLOOD DEPTH



**FIGURE 003**  
 108003-49  
 DATE: 2021-05-18





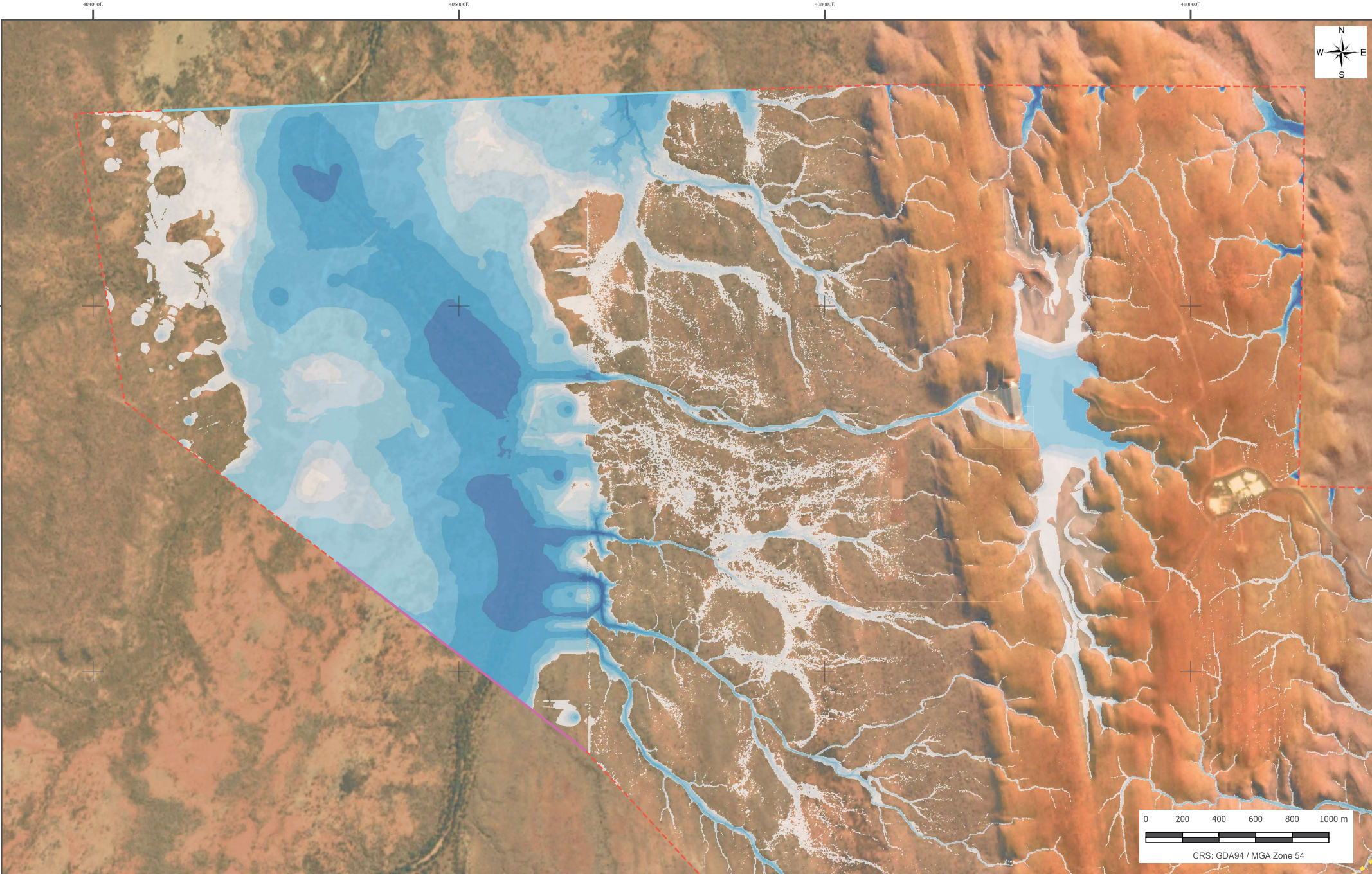
LEGEND	ELEVATION (RL m)	MAXIMUM VELOCITY (m/sec)
OUTFLOW BOUNDARY	170  275	0.3 - 0.6  0.8 - 1.0  > 2.5
INFLOW BOUNDARY	205  310	0.6 - 0.8  1.0 - 1.5
TUFLOW MODEL BOUNDARY	240	0.6 - 0.8  1.5 - 2.5

MMG AUSTRALIA PTY LTD  
 DUGALD RIVER MINE  
 TSF 0.1% AEP - MAXIMUM FLOOD VELOCITY



**FIGURE 004**  
 108003-49  
 DATE: 2021-05-18





**LEGEND**

- OUTFLOW BOUNDARY
- INFLOW BOUNDARY
- TUFLOW MODEL BOUNDARY

**ELEVATION (RL m)**

<span style="background-color: #c8e6c9; border: 1px solid black; display: inline-block; width: 15px; height: 10px;"></span> 170	<span style="background-color: #fff9c4; border: 1px solid black; display: inline-block; width: 15px; height: 10px;"></span> 275
<span style="background-color: #e0f2f1; border: 1px solid black; display: inline-block; width: 15px; height: 10px;"></span> 205	<span style="background-color: #ffe0b2; border: 1px solid black; display: inline-block; width: 15px; height: 10px;"></span> 310
<span style="background-color: #fff176; border: 1px solid black; display: inline-block; width: 15px; height: 10px;"></span> 240	

**MAXIMUM DEPTH (m)**

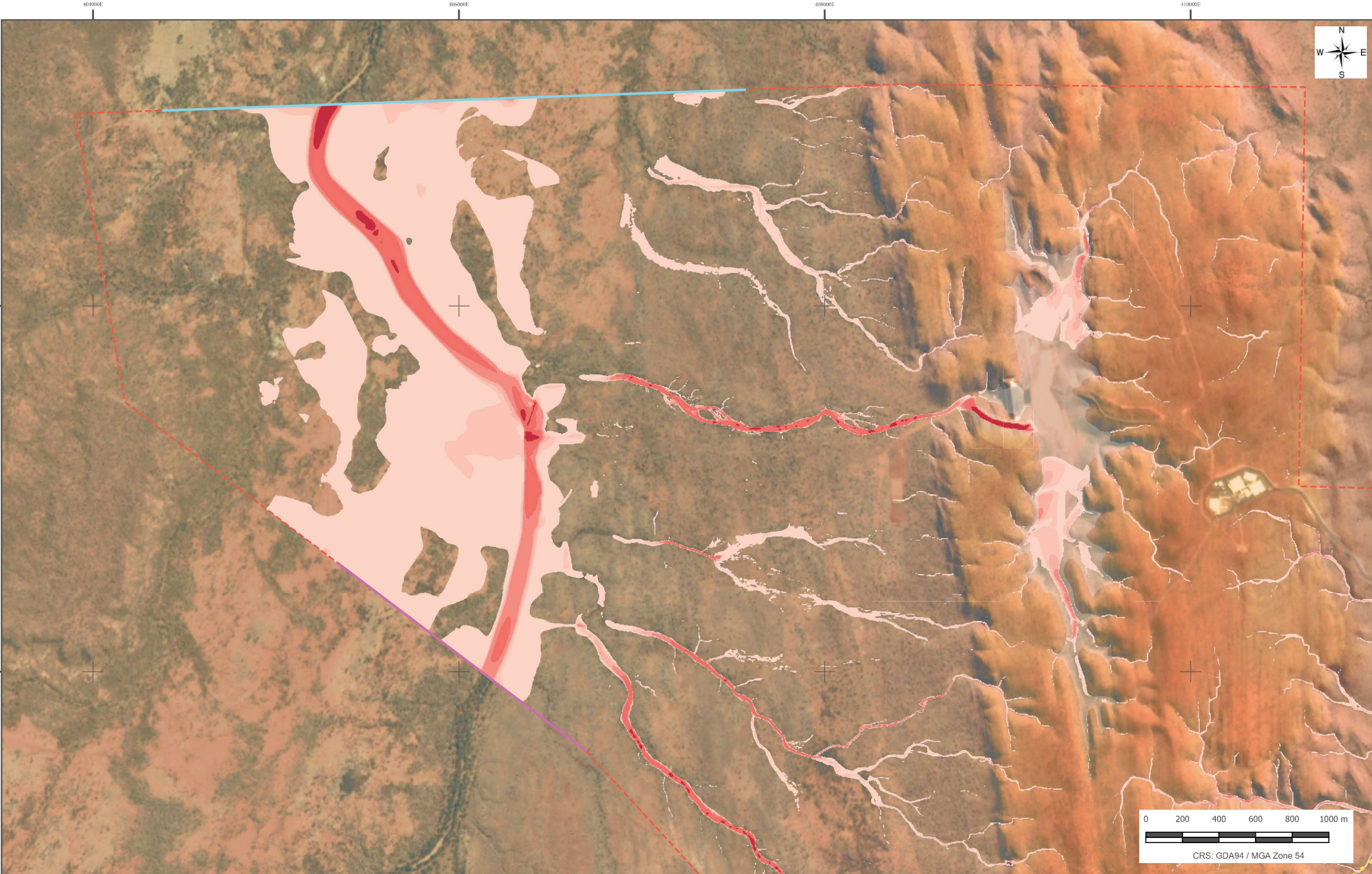
<span style="background-color: #e1bee7; border: 1px solid black; display: inline-block; width: 15px; height: 10px;"></span> 0.3 - 0.5	<span style="background-color: #bbdefb; border: 1px solid black; display: inline-block; width: 15px; height: 10px;"></span> 1.5 - 2.5	<span style="background-color: #9575cd; border: 1px solid black; display: inline-block; width: 15px; height: 10px;"></span> 5.0 - 7.5
<span style="background-color: #cfe2f3; border: 1px solid black; display: inline-block; width: 15px; height: 10px;"></span> 0.5 - 0.8	<span style="background-color: #42a5f5; border: 1px solid black; display: inline-block; width: 15px; height: 10px;"></span> 2.5 - 3.5	<span style="background-color: #3949ab; border: 1px solid black; display: inline-block; width: 15px; height: 10px;"></span> > 7.5
<span style="background-color: #90caf9; border: 1px solid black; display: inline-block; width: 15px; height: 10px;"></span> 0.8 - 1.5	<span style="background-color: #2196f3; border: 1px solid black; display: inline-block; width: 15px; height: 10px;"></span> 5.0 - 7.5	

MMG AUSTRALIA PTY LTD  
 DUGALD RIVER MINE  
 TSF 1.0% AEP - MAXIMUM FLOOD DEPTH



**FIGURE 005**  
 108003-49  
 DATE: 2021-05-18





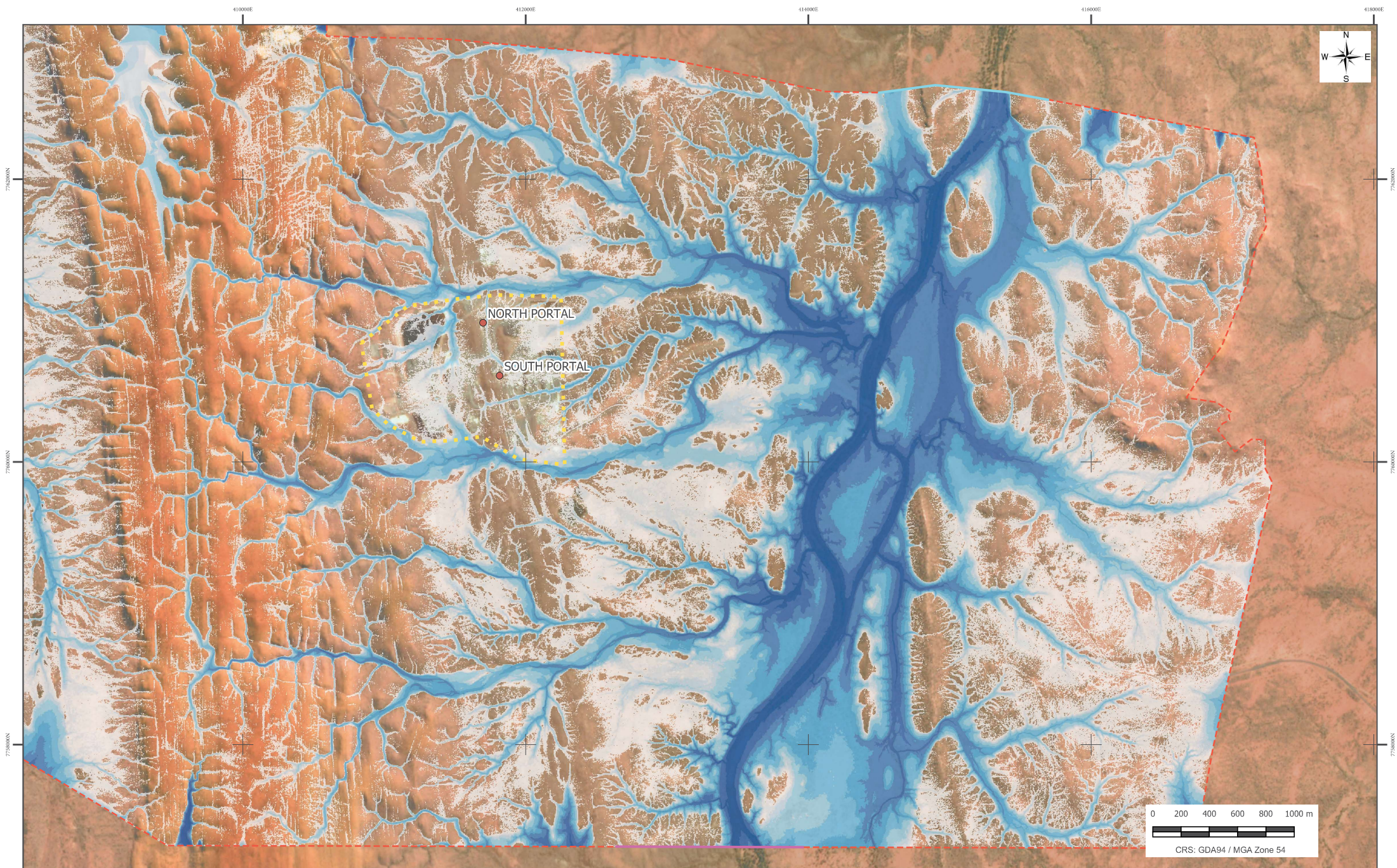
LEGEND	ELEVATION (RL m)	MAXIMUM VELOCITY (m/sec)
OUTFLOW BOUNDARY	170	0.3 - 0.6
INFLOW BOUNDARY	205	0.6 - 0.8
TUFLOW MODEL BOUNDARY	240	0.8 - 1.0
	275	1.0 - 1.5
	310	1.5 - 2.5
	340	> 2.5

MMG AUSTRALIA PTY LTD  
 DUGALD RIVER MINE  
 TSF 1.0% AEP - MAXIMUM FLOOD VELOCITY



**FIGURE 006**  
 108003-49  
 DATE: 2021-05-18





LEGEND

- OUTFLOW BOUNDARY
- INFLOW BOUNDARY
- TUFLOW MODEL BOUNDARY
- PA EXTENT

ELEVATION (RL m)

- 170
- 205
- 240
- 275
- 310

MAXIMUM DEPTH (m)

- |  |  |  |
|--|--|--|
| <span style="display: inline-block; width: 15px; height: 15px; background-color: #e1bee7;"></span> 0.3 - 0.5 | <span style="display: inline-block; width: 15px; height: 15px; background-color: #9575cd;"></span> 1.5 - 2.5 | <span style="display: inline-block; width: 15px; height: 15px; background-color: #3949ab;"></span> 5.0 - 7.5 |
| <span style="display: inline-block; width: 15px; height: 15px; background-color: #bbdefb;"></span> 0.5 - 0.8 | <span style="display: inline-block; width: 15px; height: 15px; background-color: #00bcd4;"></span> 2.5 - 3.5 | <span style="display: inline-block; width: 15px; height: 15px; background-color: #000000;"></span> > 7.5     |
| <span style="display: inline-block; width: 15px; height: 15px; background-color: #bbdefb;"></span> 0.8 - 1.5 | <span style="display: inline-block; width: 15px; height: 15px; background-color: #00bcd4;"></span> 5.0 - 7.5 |  |

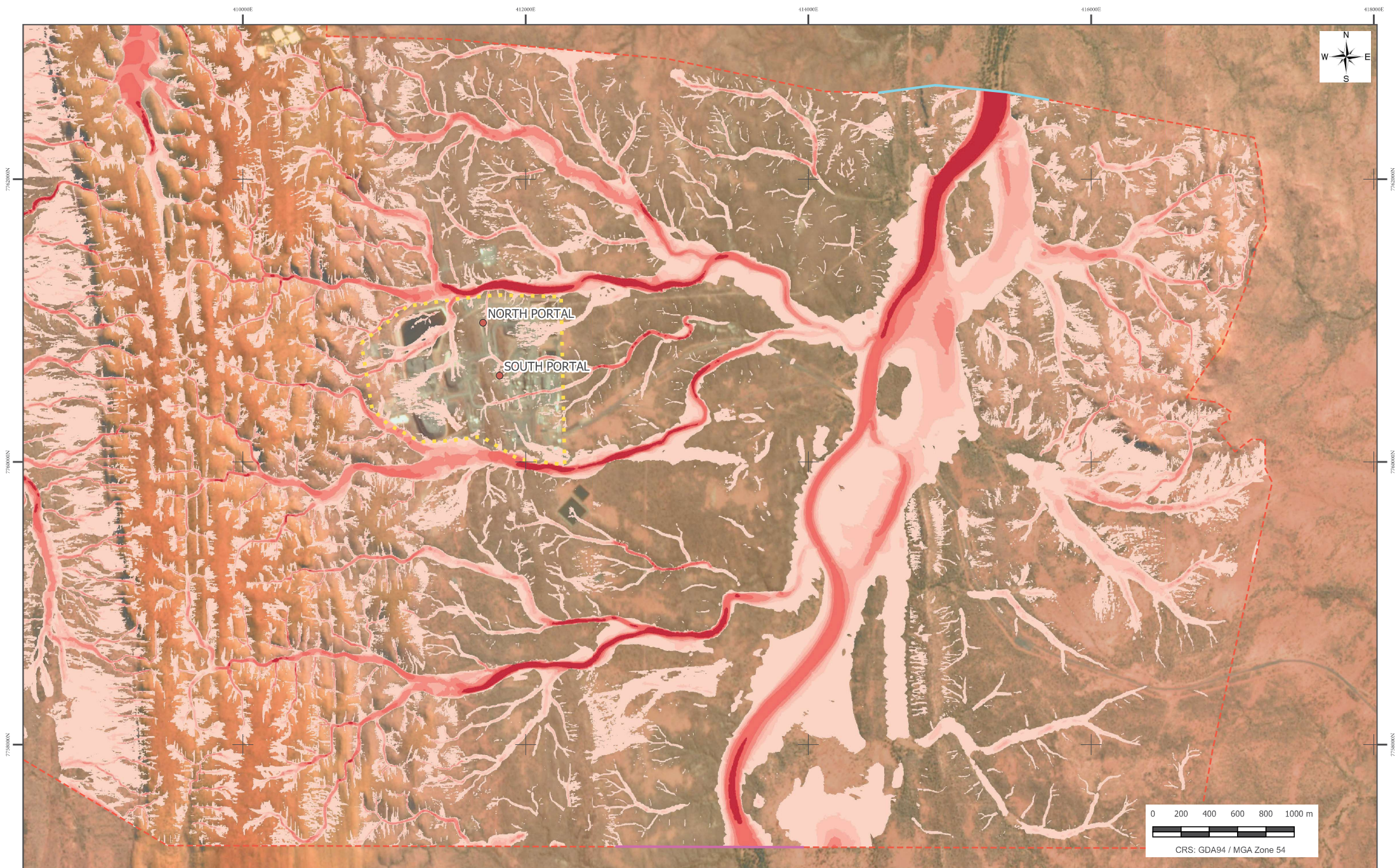
MMG AUSTRALIA PTY LTD  
 DUGALD RIVER MINE  
 PROCESS AREA PMP - MAXIMUM FLOOD DEPTH



FIGURE 007

108003-49  
 DATE: 2021-05-18





**LEGEND**

- OUTFLOW BOUNDARY
- INFLOW BOUNDARY
- TUFLOW MODEL BOUNDARY
- PA EXTENT

**ELEVATION (RL m)**

- 170
- 205
- 240
- 275
- 310

**MAXIMUM VELOCITY (m/sec)**

- 0.3 - 0.6
- 0.6 - 0.8
- 0.6 - 0.8
- 0.8 - 1.0
- 1.0 - 1.5
- 1.5 - 2.5
- > 2.5

MMG AUSTRALIA PTY LTD  
 DUGALD RIVER MINE  
 PROCESS AREA PMP - MAXIMUM FLOOD VELOCITY

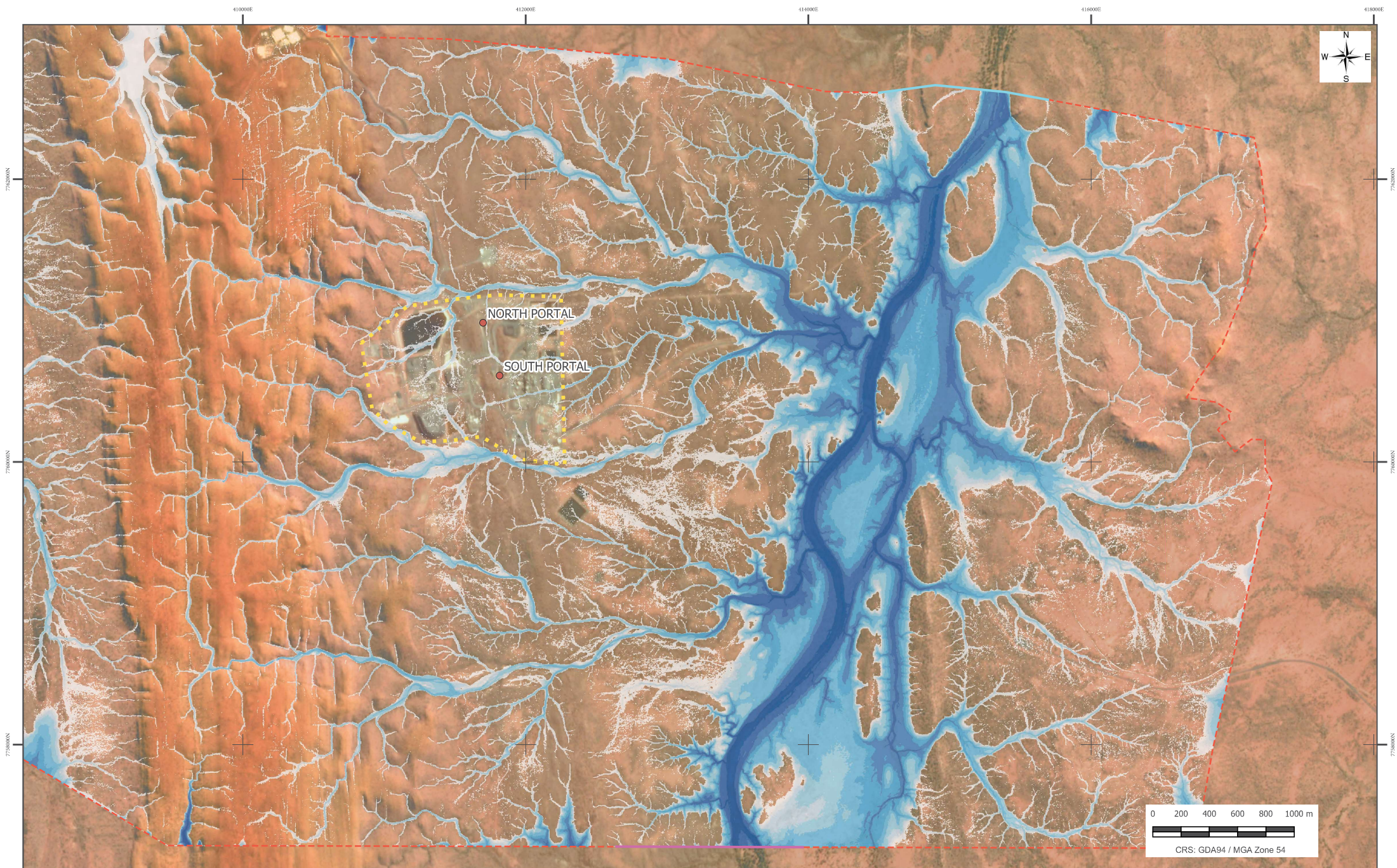


**FIGURE 008**

108003-49

DATE: 2021-05-18





**LEGEND**

- OUTFLOW BOUNDARY
- INFLOW BOUNDARY
- TUFLOW MODEL BOUNDARY
- PA EXTENT

**ELEVATION (RL m)**

- 170
- 275
- 205
- 310
- 240

**MAXIMUM DEPTH (m)**

- 0.3 - 0.5
- 1.5 - 2.5
- 5.0 - 7.5
- 0.5 - 0.8
- 2.5 - 3.5
- > 7.5
- 0.8 - 1.5
- 5.0 - 7.5

MMG AUSTRALIA PTY LTD  
 DUGALD RIVER MINE  
 PROCESS AREA 0.1% AEP - MAXIMUM FLOOD DEPTH

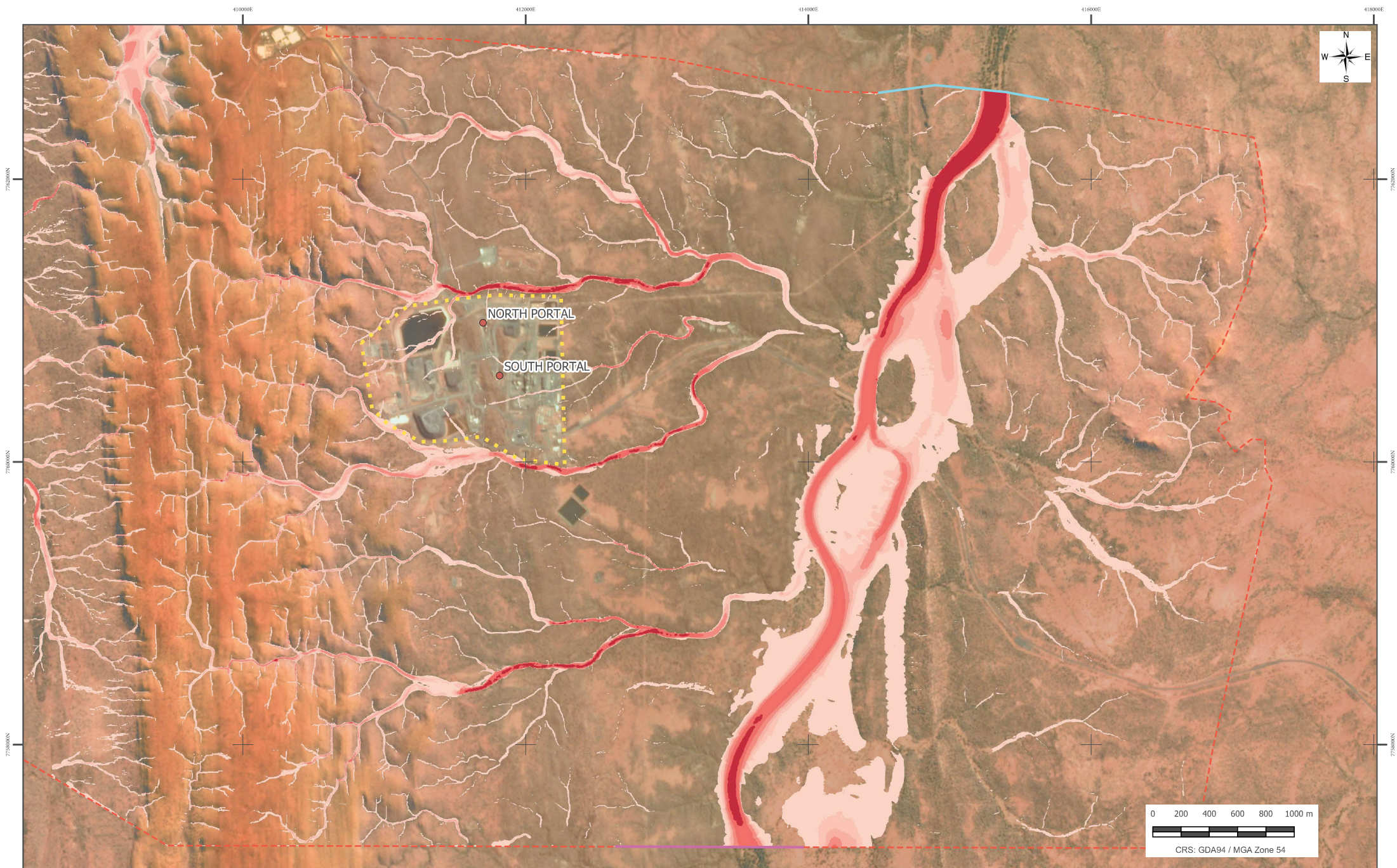


**FIGURE 009**

108003-49

DATE: 2021-05-18





LEGEND

- OUTFLOW BOUNDARY
- INFLOW BOUNDARY
- TUFLOW MODEL BOUNDARY
- PA EXTENT

ELEVATION (RL m)

- 170
- 275
- 205
- 310
- 240

MAXIMUM VELOCITY (m/sec)

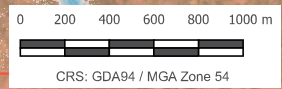
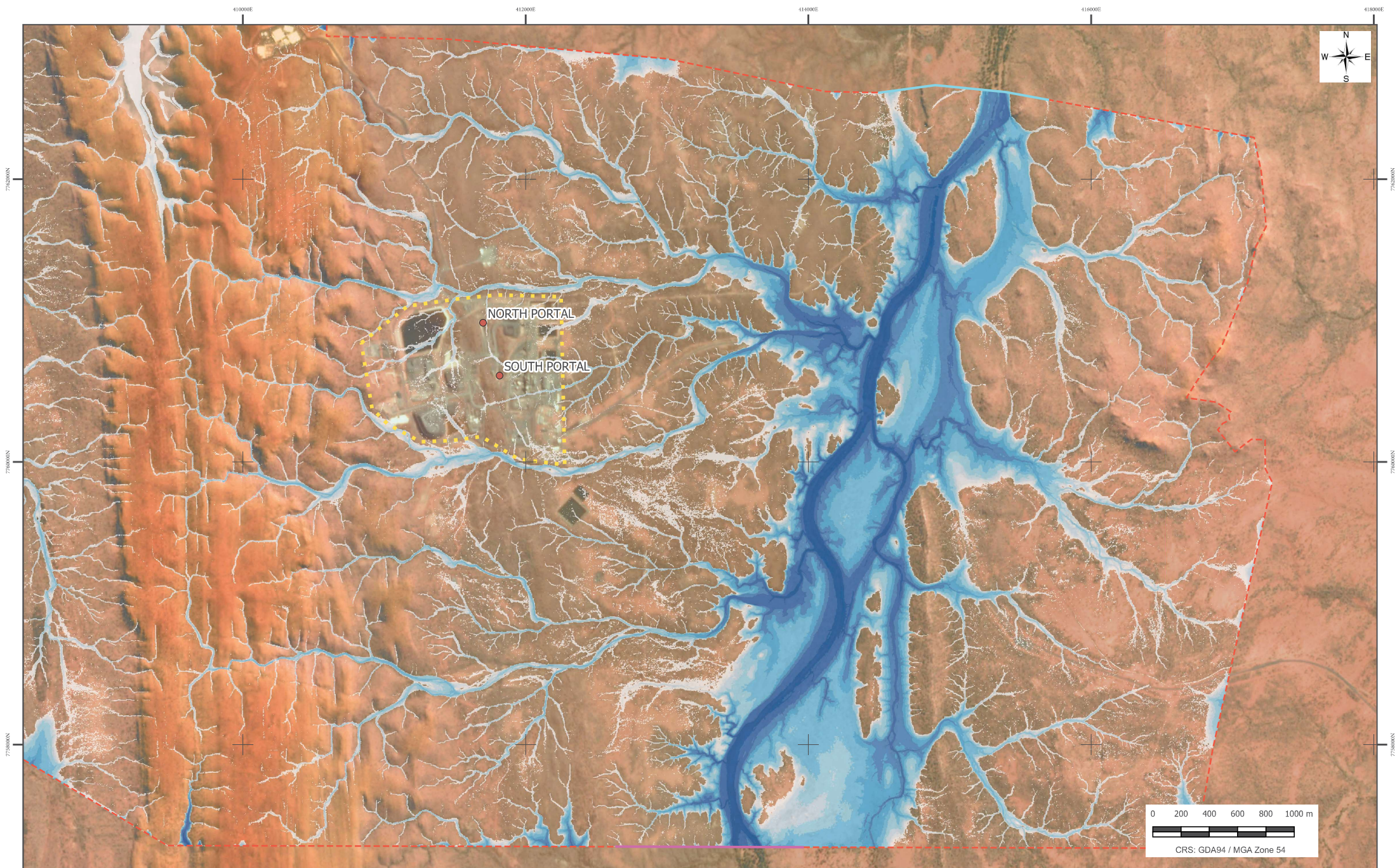
- 0.3 - 0.6
- 0.8 - 1.0
- > 2.5
- 0.6 - 0.8
- 1.0 - 1.5
- 1.5 - 2.5

MMG AUSTRALIA PTY LTD  
 DUGALD RIVER MINE  
 PROCESS AREA 0.1% AEP - MAXIMUM FLOOD VELOCITY



**FIGURE 010**  
 108003-49  
 DATE: 2021-05-18





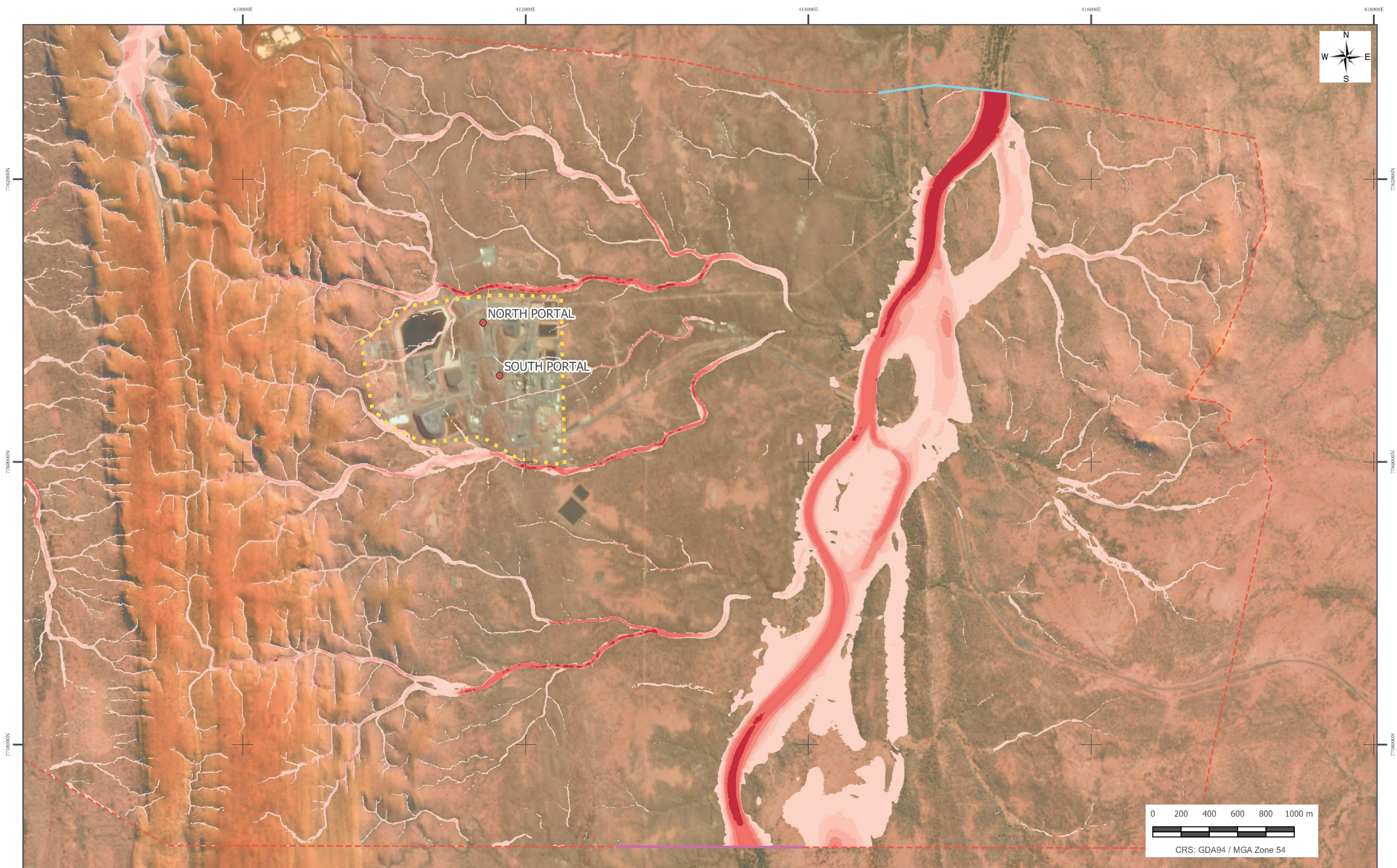
LEGEND		ELEVATION (RL m)		MAXIMUM DEPTH (m)					
	OUTFLOW BOUNDARY		170		0.3 - 0.5		1.5 - 2.5		5.0 - 7.5
	INFLOW BOUNDARY		275		0.5 - 0.8		2.5 - 3.5		> 7.5
	TUFLOW MODEL BOUNDARY		205		0.8 - 1.5		5.0 - 7.5		
	PA EXTENT		310						
			240						

MMG AUSTRALIA PTY LTD  
 DUGALD RIVER MINE  
 PROCESS AREA 1.0% AEP - MAXIMUM FLOOD DEPTH



**FIGURE 011**  
 108003-49  
 DATE: 2021-05-18





**LEGEND**

- OUTFLOW BOUNDARY
- INFLOW BOUNDARY
- TUFLOW MODEL BOUNDARY
- PA EXTENT

**ELEVATION (RL m)**

- 170
- 275
- 205
- 310
- 240

**MAXIMUM VELOCITY (m/sec)**

- 0.3 - 0.6
- 0.8 - 1.0
- 0.6 - 0.8
- 1.0 - 1.5
- 0.6 - 0.8
- 1.5 - 2.5
- > 2.5

MMG AUSTRALIA PTY LTD  
 DUGALD RIVER MINE  
 PROCESS AREA 1.0% AEP - MAXIMUM FLOOD VELOCITY



**FIGURE 012**  
 108003-49  
 DATE: 2021-05-18



---

## APPENDICES



---

**APPENDIX A**

**PMP CALCULATIONS**



## Generalised Short-Duration Method (GSDM)

### LOCATION INFORMATION

Catchment Name		Dugald River Mine and TSF		<i>Reference:</i> Generalised Short Duration Method (BOM, 2003)	
Catchment Area		16.6 km <sup>2</sup>			
State		Qld			
Latitude	Longitude	Duration Limit	Prop Smooth	Prop Rough	
-20.224	140148.000	6 Hrs	0%	100%	

### ELEVATION ADJUSTMENT FACTOR (EAF)

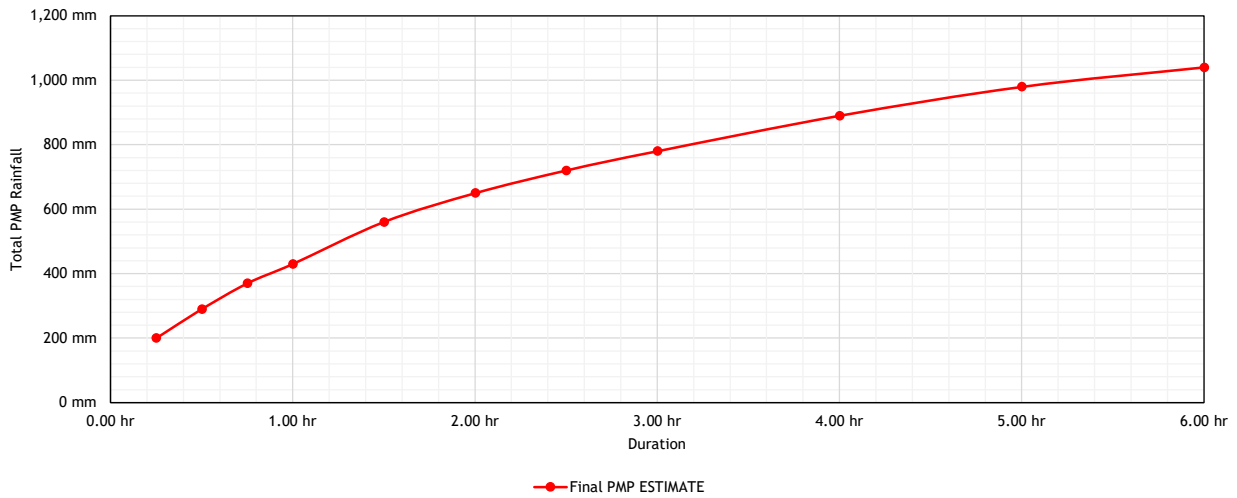
Mean Elevation at Site Location:	236 m	EAF	1
----------------------------------	-------	-----	---

### MOISTURE ADJUSTMENT FACTOR (MAF)

MAF	0.960649
-----	----------

### PMP VALUES (mm)

Duration (hours)	Initial Depth - Smooth (DS)	Initial Depth - Rough (DR)	PMP Estimate = (Ds x S + DR x R) x MAF x EAF	Rounded PMP Estimate (nearest 10 mm)
0.25 hr	203.1 mm	203.1 mm	195.1 mm	200 mm
0.50 hr	298.9 mm	298.9 mm	287.2 mm	290 mm
0.75 hr	381.2 mm	381.2 mm	366.2 mm	370 mm
1.00 hr	447.6 mm	447.6 mm	429.9 mm	430 mm
1.50 hr	511.2 mm	573.3 mm	550.7 mm	560 mm
2.00 hr	573.4 mm	670.2 mm	643.9 mm	650 mm
2.50 hr	610.2 mm	740.6 mm	711.5 mm	720 mm
3.00 hr	640.3 mm	807.7 mm	775.9 mm	780 mm
4.00 hr	708.8 mm	923.7 mm	887.4 mm	890 mm
5.00 hr	763.3 mm	1,014.6 mm	974.7 mm	980 mm
6.00 hr	808.6 mm	1,081.2 mm	1,038.6 mm	1040 mm



Dugald River Mine and TSF

PMP ESTIMATES

Short Duration  
GSDM

Job No: 108003.49

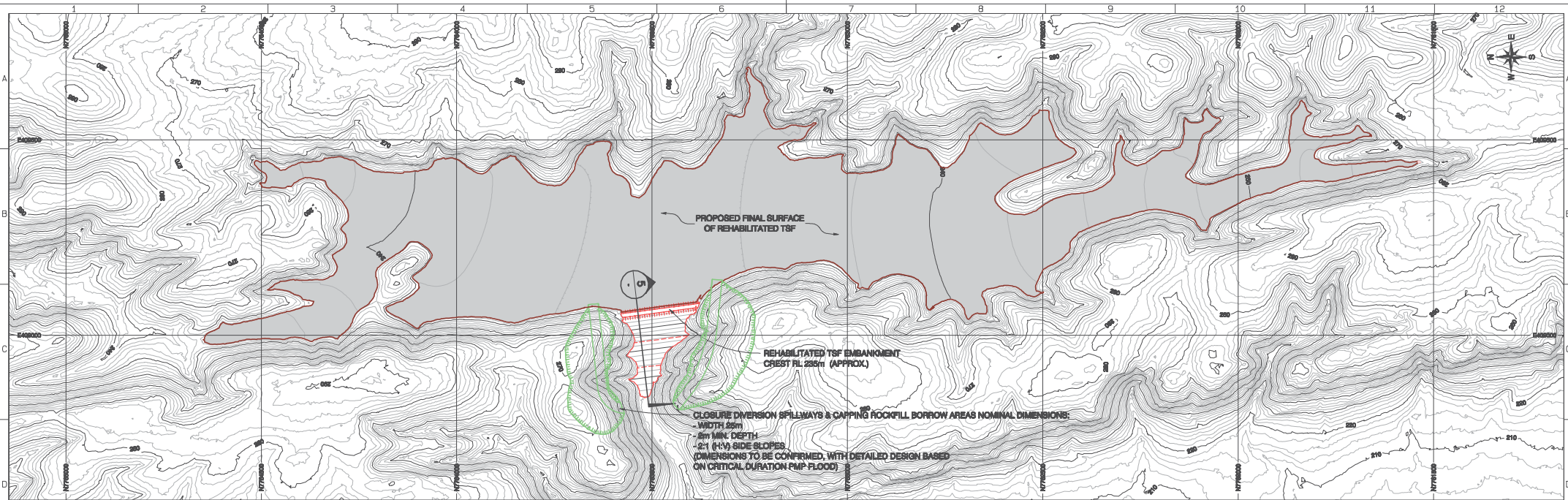
Date: 18/05/2021



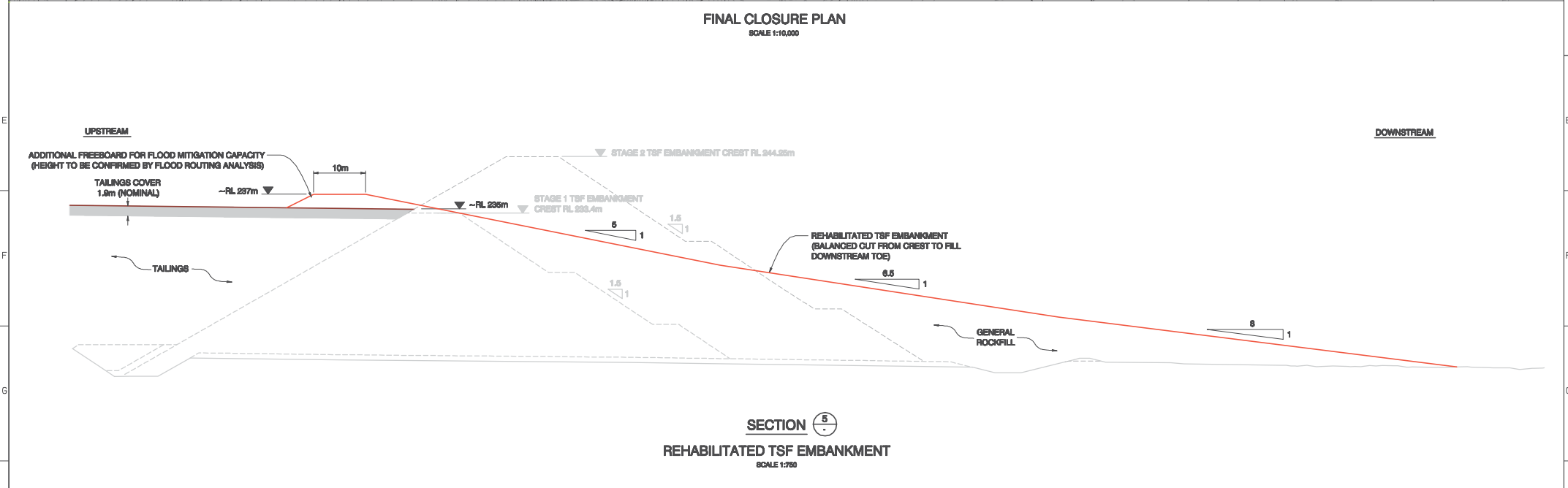
www.atcwilliams.com.au  
perth@atcwilliams.com.au  
T +61 8 9213 1600

**FIGURE 1**





**FINAL CLOSURE PLAN**  
SCALE 1:10,000



**SECTION 5**  
**REHABILITATED TSF EMBANKMENT**  
SCALE 1:750

No.	DESCRIPTION	DATE	DRAWN	CHECKED	APPRD

SCALE AS SHOWN

JOB No.	106005.20
DATE	22.02.16
DESIGN	CM
DRAWN	HR
CHECKED	
APPROVED	

Melb T +61 3 8587 0900  
melbourne@atcwilliams.com.au

**ATC Williams**  
GROUNDED IN DESIGN

A.B.N. 64 005 931 286  
www.atcwilliams.com.au

Bris T +61 7 3362 7222  
brisbane@atcwilliams.com.au

Perth T +61 8 9365 6700  
perth@atcwilliams.com.au

**MMG DUGALD RIVER  
TAILINGS STORAGE FACILITY**

**DESIGN REPORT  
CLOSURE CONCEPT**

**FIGURE 15.1**

CLIENT No.	
OND REF.	
REV. 0	SHT SIZE AS
SHEET 1 OF 1	

# **Appendix G: DRM Community and Social Performance Standard**

# COMMUNITY AND SOCIAL PERFORMANCE

## WORK QUALITY REQUIREMENT

### DUGALD RIVER MINE



**TABLE OF CONTENTS**

**1 PURPOSE.....3**

**2 SCOPE.....3**

**3 ACRONYMS AND ABBREVIATIONS.....4**

**4 LAND ACCESS AND CULTURAL HERITAGE.....4**

4.1 LAND ACCESS AND ENVIRONMENTAL AUTHORITY .....4

4.2 CULTURAL HERITAGE MANAGEMENT.....5

**5 SOCIAL BASELINE STUDIES AND SOCIAL IMPACT AND OPPORTUNITIES .....5**

5.1 SOCIAL BASELINE STUDY .....5

5.2 SOCIO ECONOMIC IMPACTS AND OPORTUNITIES .....6

**6 SOCIAL DEVELOPMENT AND COMMUNITY ENGAGEMENT.....7**

6.1 SOCIAL INVESTMENT .....7

6.2 SOCIAL COMMITMENTS .....7

6.3 COMMUNITY ENGAGEMENT.....8

**7 LOCAL EMPLOYMENT AND LOCAL SUPPLY .....8**

7.1 LOCAL EMPLOYMENT .....8

7.2 LOCAL SUPPLY.....9

**8 STAKEHOLDER GRIEVANCES AND SOCIAL INCIDENTS .....9**

**9 SOCIAL PERFORMANCE COMPETENCY.....9**

**10 MONITORING AND EVALUATION .....9**



## 1 PURPOSE

The purpose of this Work Quality Requirement (WQR) is to provide an overview of MMG's Dugald River Mine (DRM) social performance activities and to explain their significance in meeting local community expectations as well as MMG standards and international obligations. It also outlines how DRM's social performance reporting frameworks are to be used to inform and guide MMG's interactions with local/host communities (Cloncurry, Kalkadoon Traditional Owners and the North West Minerals Province which includes Mount Isa).

Recognising the 'people aspect' of MMG's business and committing to strong social performance is critical to delivering on MMG's vision 'To build the world's most respected mining company' and meeting the MMG Social Performance Standard.

MMG also adheres to international best practice, with relevant International Council of Mining and Metals (ICMM) membership commitments including:

- Principle 3: Respect human rights and the interest, cultures, customs and values of employees and communities affected by our activities.
- Principle 9: Pursue continual improvement in social performance and contribute to the social, economic and institutional development of host countries and communities. ICMM members commit to support effective management of local grievances. This is supported by meaningful engagement with local people, taking care to include women, vulnerable or marginalised groups.
- Principle 10: Proactively engage key stakeholders on sustainable development challenges and opportunities in an open and transparent manner, effectively report and independently verify progress and performance.

MMG additionally commits to align all social investment to the first six United Nations Sustainable Development Goals (UN SDGs). These include: no poverty; zero hunger; good health and wellbeing; quality education; gender equality; and clean water and sanitation.

This WQR document summarises the practical actions that MMG's DRM takes to ensure all necessary compliance in respect of the local context. Respectful efforts to minimise adverse impacts and maximise benefits in local communities also help MMG maintain its intangible, but important, social licence to operate.

N°	Document Title and Link	Document Type
1.	International Council on Mining & Metals – <a href="https://www.icmm.com/">https://www.icmm.com/</a>	Website
2.	United Nations Sustainable Development Goals <a href="https://sdgs.un.org/goals">https://sdgs.un.org/goals</a>	Website

## 2 SCOPE

This document applies to all DRM People and all activities controlled or managed by MMG or where stipulated to be in partnership with MMG. It addresses how the Social Performance Standard is met by DRM, and supports assurance of the standard, which is to be conducted periodically in line with the MMG Assurance Framework.

N°	Document Title and Link	Document Type
1.	MMG Social Performance Standard - <a href="http://mmglibrary.myintranet.local/otcs/cs.exe?func=ll&amp;objld=12975735&amp;objAction=download">http://mmglibrary.myintranet.local/otcs/cs.exe?func=ll&amp;objld=12975735&amp;objAction=download</a>	Standard
2.	MMG Assurance Framework - <a href="https://mmglibrary.mmg.com/otcs/llisapi.dll?func=ll&amp;objld=40863121&amp;objAction=download&amp;viewType=1">https://mmglibrary.mmg.com/otcs/llisapi.dll?func=ll&amp;objld=40863121&amp;objAction=download&amp;viewType=1</a>	Framework

### 3 ACRONYMS AND ABBREVIATIONS

LIST OF ACRONYMS AND ABBREVIATIONS			
DRM	Dugald River Mine	EIS	Environmental Impact Statement
ICMM	International Council on Mining & Metals	KPIs	Key Performance Indicators
SBS	Socio-economic Baseline Study	SIMP	Socio-economic Impact Management Plan
SMP	Stakeholder Management Plan	SIOA	Socio-economic Impact and Opportunities Assessment
SIP	Social Investment Plan	The EA	Environmental Authority EPML00731213
UNSDGs	United Nations Sustainable Development Goals	WQR	Work Quality Requirement

### 4 LAND ACCESS AND CULTURAL HERITAGE

All activities controlled by MMG’s DRM are established and operated on lands owned or leased by MMG and secured through processes that respect legal and traditional rights of landholders.

#### 4.1 LAND ACCESS AND ENVIRONMENTAL AUTHORITY

Activities at MMG DRM is authorised under the *Mineral Resources Act 1989*, and the *Environmental Protection Act 1994*. This is reflected in Environmental Authority EPML00731213 (the EA). The EA sets the minimums standards for environmental protection. MMG then has a series of procedures and work quality requirements to ensure obligations required under the EA are met.

The EA requires that MMG’s DRM consult, promote and maintain easily accessible lines of communication between residents, stakeholders and landowners. MMG facilitates this by hosting regular community consultation meetings (Community Consultative Group and Kalkadoon meetings both occur within no more than 6 months intervals A26). Contact details are also provided on the MMG website ([www.mmg.com](http://www.mmg.com)), and in the window of MMG’s Cloncurry office as follows:

General Enquiries/Site Contact  
 Phone: +61 7 4442 0630  
 Email: [dr\\_siteadmin@mmg.com](mailto:dr_siteadmin@mmg.com)

Community Issues/Grievances  
 Phone: +61 1800 532 007  
 Email: [dugaldrivercsp@mmg.com](mailto:dugaldrivercsp@mmg.com)

N°	Document Title and Link	Document Type
1.	DRM Environmental Authority EPML00731213 - <a href="https://mmglibrary.mmg.com/otcs/llisapi.dll/app/nodes/15153694">https://mmglibrary.mmg.com/otcs/llisapi.dll/app/nodes/15153694</a>	Environmental Authority
2.	Mineral Resources Act 1989 - <a href="https://www.legislation.qld.gov.au/view/html/inforce/current/act-1989-110">https://www.legislation.qld.gov.au/view/html/inforce/current/act-1989-110</a>	Legislation
3.	Environmental Protection Act 1994 - <a href="https://www.legislation.qld.gov.au/view/pdf/inforce/current/act-1994-062">https://www.legislation.qld.gov.au/view/pdf/inforce/current/act-1994-062</a>	Legislation

## 4.2 CULTURAL HERITAGE MANAGEMENT

MMG's DRM values and respects local cultures and traditions, particularly that of the Kalkadoon Traditional Owners. Cultural Heritage agreements for DRM between MMG and the Kalkadoon People have been designed to comply with the *Queensland Aboriginal Cultural Heritage Act 2003*, *The Queensland Heritage Act 1992* and *Torres Strait Islander Cultural Heritage Act 2003*. These are reflected in the ancillary agreement between Oz Minerals/MMG and the Kalkadoon People and the cultural heritage management procedure.

These documents define the base standards MMG's DRM must adhere to in complying with the agreements and legislation.

N°	Document Title and Link	Document Type
1.	Oz Minerals/MMG and Kalkadoon Agreement - <a href="https://mmglibrary.mmg.com/otcs/cs.exe/app/nodes/1663383">https://mmglibrary.mmg.com/otcs/cs.exe/app/nodes/1663383</a>	Agreement
2.	DRM Cultural Heritage Management Procedure - <a href="https://mmglibrary.mmg.com/otcs/llisapi.dll/app/nodes/39260027">https://mmglibrary.mmg.com/otcs/llisapi.dll/app/nodes/39260027</a>	Procedure
3.	Queensland Aboriginal Cultural Heritage Act 2003 - <a href="https://www.legislation.qld.gov.au/view/html/inforce/current/act-2003-079">https://www.legislation.qld.gov.au/view/html/inforce/current/act-2003-079</a>	Legislation
4.	The Queensland Heritage Act 1992 - <a href="https://www.legislation.qld.gov.au/view/html/inforce/current/act-1992-009">https://www.legislation.qld.gov.au/view/html/inforce/current/act-1992-009</a>	Legislation
5.	Torres Strait Islander Cultural Heritage Act 2003 - <a href="https://www.legislation.qld.gov.au/view/html/inforce/current/act-2003-080">https://www.legislation.qld.gov.au/view/html/inforce/current/act-2003-080</a>	Legislation

## 5 SOCIAL BASELINE STUDIES AND SOCIAL IMPACT AND OPPORTUNITIES

A socio-economic baseline study (SBS) and socio-economic impact and opportunities assessment (SIOA) were completed by Nation Partners in 2019 to comply with MMG's Social Performance Standard, which requires these reports are updated at least every 5 years (in line with international best practice). The Nation Partners reports build on, and provide an update to, those prepared in 2010/11 by AustralAsian Resource Consultants, as part of DRM's Environmental Impact Statement (EIS) under the *Environmental Protection Act 1994*.

The SBS and SIOA have slightly different focuses as explained below, although collectively identify demographic aspects, issues and perceptions of stakeholders and interested parties from communities local to DRM. The SBS provides rich and important contextual information about the local communities, however the SIOA is the key report of interest from a social performance perspective and in the eyes of regulators because it focuses on the meaningful management of socio-economic impacts and opportunities associated with DRM. This helps build earnest project support from local communities and in turn, a social licence to operate.

## 5.1 SOCIAL BASELINE STUDY

The SBS prepared for MMG by Nation Partners in 2019 profiles the key socio-economic and cultural characteristics of regional and local communities which interface with MMG's DRM. The focus of the SBS is on objectively investigating past, current and projected socio-economic data. This helps MMG understand the community dynamics that existed prior to, and independent of, DRM versus those which appear to have been influenced by the project. The SBS therefore informs the SIOA by providing insights into the community's likely vulnerability to project influences and potentially its ability to adapt to change. SBS data also provides benchmark conditions against which potential social impacts can subsequently be measured and monitored over time. Furthermore, the findings of the SBS are very valuable because they help MMG's DRM understand who their local communities are relative to other sites, and inform the design and nature of DRM's stakeholder engagement and social investment activities so they are culturally and contextually appropriate.

N°	Document Title and Link	Document Type
1.	Dugald River Mine – Social Baseline Study - <a href="https://mmglibrary.mmg.com/otcs/llisapi.dll/app/nodes/38399043">https://mmglibrary.mmg.com/otcs/llisapi.dll/app/nodes/38399043</a>	Report
2.	Environmental Protection Act 1994 - <a href="https://www.legislation.qld.gov.au/view/pdf/inforce/current/act-1994-062">https://www.legislation.qld.gov.au/view/pdf/inforce/current/act-1994-062</a>	Legislation

## 5.2 SOCIO ECONOMIC IMPACTS AND OPORUNITIES

The SIOA prepared for MMG by Nation Partners in 2019 reports on project-related socio-economic impacts and opportunities on surrounding local and regional study communities. It covers the identification, analysis, assessment, management and monitoring of a project's social and economic impacts, both positive and negative. In contrast to the SBS, the SIOA draws on baseline data in conjunction with community engagement feedback regarding the project and comparable project experiences elsewhere to analyse key issues as assessable social and economic impacts and opportunities associated with DRM. The SIOA includes impact management measures and impact monitoring and is typically accompanied with a supporting socio-economic impact management plan (SIMP). Nation Partners prepared a DRM SIMP in 2019. SIMPs have long been considered international best practice, although are now mandatory in Queensland whenever an EIS process is triggered for large resource projects. This is due to the introduction of the *Strong and Sustainable Resource Communities Act 2017* which mandates use of the Queensland Government's 2018 Social Impact Assessment Guidelines. These guidelines were followed when preparing the SIOA and SIMP.

N°	Document Title and Link	Document Type
1.	Dugald River Mine – Social Impacts and Opportunities - <a href="https://mmglibrary.mmg.com/otcs/llisapi.dll/app/nodes/38439710">https://mmglibrary.mmg.com/otcs/llisapi.dll/app/nodes/38439710</a>	Report
2.	Environmental Protection Act 1994 - 1994 <a href="https://www.legislation.qld.gov.au/view/pdf/inforce/current/act-1994-062">https://www.legislation.qld.gov.au/view/pdf/inforce/current/act-1994-062</a>	Legislation

3.	Strong and Sustainable Resource Communities Act 2017 - <a href="https://www.legislation.qld.gov.au/view/pdf/inforce/current/act-2017-028">https://www.legislation.qld.gov.au/view/pdf/inforce/current/act-2017-028</a>	Legislation
4.	Queensland 2018 Social Impact Assessment Guidelines - <a href="https://www.statedevelopment.qld.gov.au/coordinator-general/strong-and-sustainable-resource-communities/social-impact-assessment">https://www.statedevelopment.qld.gov.au/coordinator-general/strong-and-sustainable-resource-communities/social-impact-assessment</a>	Guidelines
5.	Dugald River Mine – Socio-Economic Impact Management Plan - <a href="https://mmglibrary.mmg.com/otcs/llisapi.dll/app/nodes/39097377">https://mmglibrary.mmg.com/otcs/llisapi.dll/app/nodes/39097377</a>	Plan

## 6 SOCIAL DEVELOPMENT AND COMMUNITY ENGAGEMENT

Dugald River Mine is committed to the future of our local/host communities through supporting education and skills development for future generations as well as preserving the history of our region's through infrastructure and legacy preservation. Social investments, social commitments and community engagement tools are used to achieve these outcomes which will create MMG's long term positive legacy.

### 6.1 SOCIAL INVESTMENT

A DRM Social Investment Plan (SIP) was prepared by Nation Partners in 2019 to create improved processes for managing MMG's social investment, which is defined to incorporate multi-stakeholder partnerships, social development programs, sponsorships and community contributions (including employee volunteering). The SIP outlines community goals for Cloncurry and Kalkadoon (distilled from community engagement feedback), local and regional government planning directives and MMG's business drivers and sustainability objectives. These are integrated into social investment criteria to promote maximum shared value for community, government and MMG. The SIP contains a practical tool to apply the criteria and allow social investment proposals to be objectively evaluated to better determine how available funding can best be utilised to positively contribute to the social and economic development of the area. MMG have also updated MMG's DRM Sponsorship Program Application Kit form, which helps community members preparing a proposal to clearly demonstrate the anticipated benefit and any shared value across stakeholder groups.

MMG's DRM develop a yearly social development investment budget, aligned with the Social Performance Standard and the DRM Social Investment Plan, and track progress. Borealis is to be used to store social investment and sponsorship proposals, decisions, agreements, and evaluations, and report on key milestones and community contributions (cash and in-kind), to ensure reporting is based on DRM's total social investment. Investments are to be assessed using appropriate metrics where possible to evaluate whether anticipated benefits have materialised (See SIMP for monitoring and evaluation guidance).

N°	Document Title and Link	Document Type
1.	Dugald River Mine - Social Investment Plan - <a href="https://mmglibrary.mmg.com/otcs/llisapi.dll/app/nodes/38439397">https://mmglibrary.mmg.com/otcs/llisapi.dll/app/nodes/38439397</a>	Plan
2.	MMG Sponsorship Program – Application Kit <a href="http://www.mmg.com/en/Our-Operations/Mining-operations/Dugald-River.aspx">http://www.mmg.com/en/Our-Operations/Mining-operations/Dugald-River.aspx</a>	Form
3.	Dugald River Mine – Socio-Economic Impact Management Plan <a href="https://mmglibrary.mmg.com/otcs/llisapi.dll/app/nodes/39097377">https://mmglibrary.mmg.com/otcs/llisapi.dll/app/nodes/39097377</a>	Plan

## 6.2 SOCIAL COMMITMENTS

The DRM Social Commitments and Agreements Procedure outlines the processes and requirements for commitment and agreement making, and for establishing and maintaining the DRM site-level Social Commitments and Agreements Register through Borealis (MMG's stakeholder management system). A commitment is defined as a pledge, promise and/or public or private statement of intent to do something for someone on behalf of MMG while an Agreement is a decision or arrangement between MMG and one or more stakeholders. More detailed interpretations of these terms are provided in the procedure. Designed for internal use, the procedure ensures that commitments are made with due consideration of the potential benefits and risks and are appropriately authorised. It also holds MMG's personnel accountable for commitments and agreements made internally as well as those made with, and for, external stakeholders.

N°	Document Title and Link	Document Type
1.	Dugald River Mine - Social Commitments and Agreements Procedure - <a href="https://mmglibrary.mmg.com/otcs/llisapi.dll/app/nodes/6952270">https://mmglibrary.mmg.com/otcs/llisapi.dll/app/nodes/6952270</a>	Procedure

## 6.3 COMMUNITY ENGAGEMENT

A Stakeholder Management Plan (SMP) was prepared by Nation Partners for MMG in 2020 to guide communications with stakeholders and manage relationships across the lifecycle of the DRM, with a focus on operations. It provides a framework for comprehensive and strategic planning of community engagement activities. It also supports long-term improvements to the social performance of the DRM, enhancing MMG's reputation among local communities and helping the company build and maintain a social license to operate.

Prepared in alignment with ICMM principles and the International Association for Public Participation Australasia (IAP2) Spectrum, the SMP identifies key stakeholders impacted by, or with an interest in, the DRM, and outlines areas of interest for each stakeholder group and the likely extent of the engagement. Stakeholder groups include local communities, marginalised and vulnerable groups, affected individuals and landholders, local government, local opinion leaders, health and education providers, community groups and non-government organisations. The SMP identifies tailored communications methods and tools relevant for engaging different stakeholders. Stakeholder grievance management processes are also outlined and a monitoring and evaluation framework is included to support continual improvement.

Nation Partners additionally prepared a Community Engagement Plan in 2019 to guide targeted community engagement activities occurring in support of the social performance reporting being undertaken at that time.

All stakeholder engagement activities and mapping are to be captured in Borealis.

N°	Document Title and Link	Document Type
1.	Dugald River Mine Stakeholder Management Plan	Plan
2.	Dugald River Mine – Community Engagement Plan - <a href="https://mmglibrary.mmg.com/otcs/llisapi.dll/app/nodes/30361782">https://mmglibrary.mmg.com/otcs/llisapi.dll/app/nodes/30361782</a>	Plan



## 7 LOCAL EMPLOYMENT AND LOCAL SUPPLY

### 7.1 LOCAL EMPLOYMENT

The DRM Local Employment Framework describes the MMG processes and procedures used to manage local employment at the DRM, and outlines associated benefits. It has been established in response to concerns raised by the community in 2019 in relation to the relatively low levels of local employment at the mine, and a perceived lack of commitment to change this.

MMG is committed to supporting its people to live locally, having established a variety of incentives and initiatives to encourage greater uptake of employment among the existing local community, and attract current and future DRM employees to move to the local area. The framework has been developed to articulate DRM's commitment to promoting the growth of its locally based workforce. The document highlights the package of benefits available to local employees, and MMG's broader initiatives intended to enhance the education and long-term employability of the local population and offset some of the key barriers that often deter people from living in a remote community (i.e., to encourage population growth in the region).

The DRM Local Employment Framework assists with compliance against Part 2, Section 6 of the Strong and Sustainable Resource Communities Act 2017 which states Prohibition on 100% fly-in fly-out workers for large resource projects close to local communities.

Nº	Document Title and Link	Document Type
1.	Dugald River Mine Local Employment Framework – <a href="#">Contact HR Department</a>	Framework
2.	Strong and Sustainable Resource Communities Act 2017 - <a href="https://www.legislation.qld.gov.au/view/pdf/inforce/current/act-2017-028">https://www.legislation.qld.gov.au/view/pdf/inforce/current/act-2017-028</a>	Legislation

### 7.2 LOCAL SUPPLY

DRM is committed to the regions in which we operate and endeavours to establish positive engagements with the communities in close proximity to our assets. As part of DRM's procurement strategy, we aim to develop sustainable supply options in our host communities. MMG's Dugald River Local Supply Management Plan communicates the DRM policies and measures designed to maximise local procurement opportunities. This document includes an action plan and discussion of how DRM's Sourcing and Contracting process involves MMG routinely undertaking an assessment of prospective and existing suppliers to understand their capabilities. These suppliers are provided with information regarding DRM's goods and service needs and the typical terms of engagement. MMG selects suppliers which meet required standards across safety, quality and commercial criteria. Where local suppliers demonstrate these attributes, MMG provides them with opportunities to supply DRM.

Nº	Document Title and Link	Document Type
1.	Dugald River Local Supply Management Plan - <a href="https://mmglibrary.mmg.com/otcs/llisapi.dll/app/nodes/36043146">https://mmglibrary.mmg.com/otcs/llisapi.dll/app/nodes/36043146</a>	Procedure

## 8 STAKEHOLDER GRIEVANCES AND SOCIAL INCIDENTS

DRM's grievance mechanism is a tool to strengthen engagement with local stakeholders, build trust and stakeholder support for its operations and demonstrate a commitment to respecting and upholding human rights. Through identifying potential and actual impacts, including human rights impacts, DRM can critically examine its operations and implement appropriate controls. Maintaining collaborative and positive relationships with our stakeholders is critical to the long-term success of DRM. All grievances received through the mechanism are to be responded to in a timely manner and processed through, and stored in, Borealis.

N°	Document Title and Link	Document Type
1.	Dugald River Mine - Grievance Procedure - <a href="https://mmglibrary.mmg.com/otcs/llisapi.dll/app/nodes/6991881">https://mmglibrary.mmg.com/otcs/llisapi.dll/app/nodes/6991881</a>	Procedure

## 9 SOCIAL PERFORMANCE COMPETENCY

MMG's DRM has committed to conducting a site-specific Social Performance Competency Assessment every two years for all Social Development and Community Relations employees, to identify competency gaps and training requirements, these gaps will then be loaded against employees My Commitment & My Development goals. Testing was last routinely completed in 2020 by MMG's corporate team. MMG's DRM is currently investigating alternative and more thorough systems of competency testing for application in 2022.

## 10 MONITORING AND EVALUATION

In line with its ICMM membership commitment to continual improvement in social performance, MMG's DRM recognises the importance of monitoring and evaluation. Nation Partners prepared the aforementioned SIMP and SIP reports which explicitly address monitoring and evaluation from a social performance perspective.

The SIMP provides a practical framework for the implementation of the social impact mitigation and opportunity enhancement measures outlined in the SIOA, including an overview of associated monitoring and evaluation activities. The SIMP details appropriate Key Performance Indicators (KPIs) and monitoring mechanisms to measure the extent to which each mitigation or enhancement measure implemented by MMG is successful in achieving its intended outcome.

The SIP outlines how social investment can be assessed using metrics which evaluate whether anticipated community and business benefits have materialised and other strategic goals have been satisfied. Monitoring and evaluation of the social investments (cash and in-kind) against their objectives and designated KPIs including relevant UN SDG/s occurs in Borealis. Stakeholder surveys are key in obtaining up-to-date and unbiased feedback. Nation Partners investigated DRM's social performance with surveys in 2019, while MMG regularly surveys stakeholders on its social investments to monitor and evaluate success and to support continual improvement.

N°	Document Title and Link	Document Type
1.	Dugald River Mine – Socio-Economic Impact Management Plan <a href="https://mmglibrary.mmg.com/otcs/llisapi.dll/app/nodes/39097377">https://mmglibrary.mmg.com/otcs/llisapi.dll/app/nodes/39097377</a>	Plan
2.	Dugald River Mine - Social Investment Plan - <a href="https://mmglibrary.mmg.com/otcs/llisapi.dll/app/nodes/38439397">https://mmglibrary.mmg.com/otcs/llisapi.dll/app/nodes/38439397</a>	Plan

## Appendix H: DRM Community Engagement Plan

The logo for Nation Partners, featuring the word "nation" in a lowercase sans-serif font above the word "partners" in a lowercase sans-serif font, both in white on a black background.

SOLUTIONS  
FOR COMPLEX  
PROJECTS

**Dugald River Draft  
Community Engagement  
Plan**

---

Prepared for MMG by  
Nation Partners

24 May 2019



## We help solve complex problems for projects

We believe that well-planned and targeted advice can help shape a project that is not only better developed, but is delivered more effectively, with greater acceptance and positive outcomes.

Nation Partners isn't your regular consulting firm. A certified B Corporation, we attract and develop the brightest thinkers and take an active part in shaping the world.

With expertise in projects in the government, transport, water, property and urban development sectors, we provide a suite of services aptly tailored to each client and project at hand.

---

Document title  
Dugald River Draft Community Engagement Plan

---

Version  
[0.0]

---

Date  
May 2019

---

Prepared by  
Jara McKinlay and Olivia Whitaker

---

Approved by  
Jenni Forrester

---

File name  
Dugald River Draft CEP v1.0

---

**Nation Partners Pty Ltd**  
ABN 96 166 861 892

Level 3, The Alley, 75-77 Flinders Lane  
Melbourne Vic 3000

Suite 108, 50 Holt St  
Surry Hills NSW 2010

☎ 1300 876 976

✉ [info@nationpartners.com.au](mailto:info@nationpartners.com.au)

🌐 [nationpartners.com.au](http://nationpartners.com.au)



COPYRIGHT: The concepts and information contained in this document are the property of Nation Partners Pty Ltd. Use or copying of this document in whole or in part without the written permission of Nation Partners constitutes an infringement of copyright

## Table of Contents



<b>DUGALD RIVER COMMUNITY ENGAGEMENT PLAN</b> .....	<b>3</b>
1. INTRODUCTION.....	3
2. PURPOSE AND OBJECTIVES .....	3
2.1 <i>The CEP</i> .....	3
2.2 <i>Community and Stakeholder Engagement</i> .....	3
3. APPROACH.....	4
4. RESOURCES .....	6
5. STAKEHOLDER AND ISSUES IDENTIFICATION .....	7
6. INFORMATION REQUIREMENTS FROM STAKEHOLDERS .....	9
7. PROPOSED METHODOLOGY.....	10
8. ENGAGEMENT SCHEDULE.....	12
<b>APPENDICES</b> .....	<b>14</b>
<b>APPENDIX A - ISSUES SCOPING</b> .....	<b>15</b>
<b>APPENDIX B – PROPOSED STAKEHOLDER ENGAGEMENT METHOD</b> .....	<b>18</b>
<b>APPENDIX C – SLIDE PACK FOR COMMUNITY CONSULTATIVE GROUP MEETING (AND KALKADOON MEETING)</b> .....	<b>25</b>
<b>APPENDIX D – PROPOSED MESSAGING TO STAKEHOLDERS (FOLLOW-UP EMAIL TEMPLATE)</b> .....	<b>26</b>
<b>APPENDIX E – PROPOSED MESSAGING TO STAKEHOLDERS (PRIMARY ENGAGEMENT EMAIL FOR LOW INFLUENCE/INTEREST STAKEHOLDERS)</b> .....	<b>27</b>



# Dugald River Community Engagement Plan



## 1. Introduction

Nation Partners has been engaged to undertake a suite of social performance related tasks for the Dugald River project and has prepared the following community engagement plan (CEP) to identify the communications and consultation activities required to support this work.

Dugald River mine is a zinc and lead mine located in north-western Queensland (QLD) approximately 65 kilometres northwest of Cloncurry and approximately 85 kilometres north-east of Mount Isa. It is among the top 10 largest zinc mines globally and has an expected lifespan of 25 years. During this time, it is anticipated the mine will annually process about 170,000 tonnes of zinc in zinc concentrate, plus by-products.

MMG submitted a final Environmental Impact Statement (EIS) for the project in December 2010, which was approved by the Department of Environment and Resource Management in November 2011. Construction began in August 2015 and was completed in late 2017, with first production of finished zinc concentrate leaving Dugald River on 8 November 2017. The mine successfully achieved commercial production in May 2018.

In light of the project's recent transition from construction to operation and a number of resourcing changes at the site, it is considered an opportune time to undertake targeted community and stakeholder engagement to support the updating of key social performance documents and plans.

## 2. Purpose and Objectives

### 2.1 The CEP

This CEP has been prepared to guide targeted community and stakeholder engagement in support of the suite of Dugald River social performance work being undertaken by Nation Partners to satisfy the requirements of the MMG Social Performance Standard. Nation Partners will conduct targeted community and stakeholder engagement to inform:

- a revised Social Baseline Study (SBS)
- a revised Social Impact and Opportunity Assessment (SIOA)
- a revised Social Impact Management Plan (SIMP)
- a Social Investment Plan (SIP)
- an updated Local Employment Management Plan (LEMP).

The CEP provides a framework for comprehensive and strategic planning of community engagement activities designed to:

- embody a best practice approach (see section 3)
- encourage improved levels of participation in project community engagement activities
- demonstrate respect, build trust and strengthen MMG's reputation (i.e., social licence to operate)
- obtain clear and structured feedback which is directly applicable to the social performance reports
- facilitate the development of practical and effective social management systems for application across the life of the project in collaboration with the community, and ideally with their final endorsement/approval.

### 2.2 Community and stakeholder engagement

Targeted community and stakeholder engagement is a critical input to the development of the social performance reporting. It is undertaken to:

- understand who is likely to be impacted and how
- establish the values and socio-economic characteristics of potentially affected communities

- identify and evaluate potential social impacts (positive and negative)
- develop management measures to mitigate adverse impacts and enhance positive impacts
- support monitoring and evaluation reporting, including outcomes and key social performance indicators.

Community and stakeholder engagement helps generate up-to-date qualitative research, which assists to fill information gaps in desktop research and validate or occasionally identify discrepancies in statistical data. As local stakeholders have a first-hand appreciation of the local context and how socio-economic conditions have evolved over time due to a variety of influences it makes sense to test preliminary findings and recommendations with the community before drawing any final conclusions.

Community and stakeholder engagement will also facilitate meaningful community input into the mitigation design process as well as some form of stakeholder endorsement or agreement on the outcomes of the updated social performance reporting. Local communities usually value the opportunity to be involved in developing solutions to issues affecting them, and are well placed to apply their local knowledge to advise what likely will and won't work in terms of mitigation strategies, benefit enhancement measures and monitoring activities.

### 3. Approach

This CEP has been prepared in accordance with the core values and basic principles of good practice of the International Association for Public Participation Australasia (IAP2).

The engagement process will aim to be:

- targeted at the appropriate stakeholders and focused on relevant topics
- early enough for feedback to be meaningfully considered
- informed with relevant information disseminated in advance
- meaningful in that content is clearly understandable and culturally appropriate
- supportive of a two-way exchange in information
- gender-inclusive and sufficiently diverse to reflect the stakeholder base
- free from coercion
- documented with follow up processes.

A wide range of potential key stakeholders will be contacted and informed about this work, and invited to participate. In general, those groups most directly and significantly affected will be encouraged, and naturally have more incentive, to be the most involved in applicable aspects of the social performance work. Equally where project interest, and impacts to, stakeholders are marginal, stakeholders informed of this social performance work may elect to not participate further. See Table 1 for the IAP2 Public Participation Spectrum, with the engagement of potential stakeholders on the Dugald River project expected to range anywhere from inform through to collaborate if stakeholders take an active role in the development and design of social impact mitigation and monitoring plans.

**Table 1 IAP2 Public Participation Spectrum**

## IAP2 Public Participation Spectrum

Developed by the International Association for Public Participation

INCREASING LEVEL OF PUBLIC IMPACT				
INFORM	CONSULT	INVOLVE	COLLABORATE	EMPOWER
<b>Public Participation Goal:</b>	<b>Public Participation Goal:</b>	<b>Public Participation Goal:</b>	<b>Public Participation Goal:</b>	<b>Public Participation Goal:</b>
To provide the public with balanced and objective information to assist them in understanding the problems, alternatives and/or solutions.	To obtain public feedback on analysis, alternatives and/or decisions.	To work directly with the public throughout the process to ensure that public issues and concerns are consistently understood and considered.	To partner with the public in each aspect of the decision including the development of alternatives and the identification of the preferred solution.	To place final decision-making in the hands of the public.
<b>Promise to the Public:</b>	<b>Promise to the Public:</b>	<b>Promise to the Public:</b>	<b>Promise to the Public:</b>	<b>Promise to the Public:</b>
We will keep You informed.	We will keep you informed, listen to and acknowledge concerns and provide feedback on how public input influenced the decision.	We will work with you to ensure that your concerns and issues are directly reflected in the alternatives developed and provide feedback on how public input influenced the decision.	We will look to you for direct advice and innovation in formulating solutions and incorporate your advice and recommendations into the decisions to the maximum extent possible.	We will implement what you decide.
<b>Example Tools:</b>	<b>Example Tools:</b>	<b>Example Tools:</b>	<b>Example Tools:</b>	<b>Example Tools:</b>
<ul style="list-style-type: none"> <li>● Fact sheets</li> <li>● Web Sites</li> <li>● Open houses</li> </ul>	<ul style="list-style-type: none"> <li>● Public comment</li> <li>● Focus groups</li> <li>● Surveys</li> <li>● Public meetings</li> </ul>	<ul style="list-style-type: none"> <li>● Workshops</li> <li>● Deliberate polling</li> </ul>	<ul style="list-style-type: none"> <li>● Citizen Advisory Committees</li> <li>● Consensus-building</li> <li>● Participatory decision-making</li> </ul>	<ul style="list-style-type: none"> <li>● Citizen juries</li> <li>● Ballots</li> <li>● Delegated decisions</li> </ul>

© 2000 International Association for Public Participation

A core principle integral to our approach will be to clearly define which aspects of the process stakeholders are being asked to contribute to and/or be involved in for the social performance work, and what is negotiable and not negotiable with respect to decision-making.

There are two rounds of face-to-face engagement planned, with the first being dedicated to building a greater understanding of the local communities and uncovering the full extent of relevant project-related social impacts and opportunities, and the second focused on refining concepts for mitigation, monitoring and social investment initiatives. The second round will also seek to gain stakeholder agreement/endorsement on the reporting deliverables, particularly the SIMP. Given this work is being driven by internal standards rather than regulatory requirements, the endorsement process will likely be relatively informal, documented in terms of participation, inputs and general feedback provided throughout the engagement process.

For this scope of work, targeted community and stakeholder engagement will adopt standard and well-established techniques and approaches, that stakeholders are likely to be comfortable with and which do not rely on overly complicated technology. Engagement methods will include:

- **phone introductions/interviews**, to be undertaken as an initial step with all key stakeholders and followed up with additional phone interviews, face-to-face interviews or focus groups as requested (see below). During the initial interviews, we will verify project interest and confirm what further engagement will entail with each stakeholder.
- **email**, to provide further information for key stakeholders following initial phone introductions, and for notifying low influence/interest potential key stakeholders of this work, an inviting them to participate if of interest. Email will be used for stakeholder updates, reminders, and to share draft documentation and facilitate feedback when explicitly requested by stakeholders.
- **face-to-face interviews** with key stakeholders who could not be reached via phone or who requested an in-person meeting as a follow up to the initial phone interview.
- **face-to-face focus group sessions** with multiple stakeholders from the same group or with common interests (e.g. councils).

Given it is difficult to anticipate the exact amount of time that will be spent on each community engagement activity, and based on the 45 stakeholder groups identified, we have made allowances for:

- 18 initial phone interviews (30 minutes each) supplemented with 12 follow up calls (30 minutes)
- 12 face-to-face interviews (1 hour each)
- 5 focus group sessions (1 hour each)
- 18 emails (personally tailored, although sometimes incorporating standardised group email type content taking 15 minutes each)

We plan to be flexible in our approach, allowing for two people to be on phone calls for any potentially controversial stakeholders, and to spread the time allocated across activities to wherever most demand exists. For example, if focus groups end up taking longer than anticipated, we will look to borrow time from activities where budgeted time has not been fully utilised.

As part of operating flexibly, we have contingency plans in place to ensure the engagement has a sufficiently wide reach. For example, in the event that a key stakeholder is unable or would prefer not to participate in the proposed engagement via phone interviews, then face-to-face interviews and/or focus sessions will be arranged. We will do our best to accommodate and cater to the requests of the key stakeholders through comprehensive and early planning.

The social performance activities being completed by Nation Partners are community centric in nature in that they are primarily focused on identifying, managing and monitoring impacts on, and opportunities for, the community as opposed to MMG as a business. That said, feedback from community and stakeholder engagement is likely to provide useful insights into how community and social impacts in turn represent risks and opportunities for the project and MMG.

#### 4. Resources

Nation Partners proposes to send two of our team members to Cloncurry to undertake face-to-face interviews and targeted focus group sessions in order to:

- allow one person to lead the engagement and the other to support and scribe feedback
- help to formalise the process and demonstrate commitment, making stakeholders feel valued
- reduce the likelihood of any stakeholders subsequently developing differing versions of events and accounts of what was said and agreed upon.

For each of the two rounds of engagement, one Nation Partners team member will fly from Melbourne and the other from Brisbane, both for a three day stay in Mount Isa and Cloncurry, with shared vehicle hire.

Nation Partners will require access to the Cloncurry Community Information Centre/MMG Project Office over the period of time that the face-to-face engagement is to occur, with some form of basic catering to be provided by MMG (e.g. coffee/tea and biscuits).

## 5. Stakeholder and issues identification

This section identifies a list of potential key stakeholders along with possible issues/interests they may have in the Dugald River project and the social performance work being undertaken. A stakeholder is defined as any individual, group of individuals, organisation or political entity with an interest in the outcome of a decision. Stakeholders may be, or perceive they may be, affected directly or indirectly by the outcome of a decision.

Early identification of stakeholders enhances the consultation process by enabling more time for planning, stakeholder notifications and tailoring of the engagement approach as appropriate. It therefore supports greater participation, greater efficiencies and an improved likelihood of generating desired outcomes/outputs.

Potential stakeholders have been profiled where an interest in, issue with or capacity to influence the project and planned social performance work has been identified. The proposed list of stakeholders embodies a good cross-representation of the community, and has been developed using the draft SIMP prepared by ARC in 2011 coupled with recent feedback from MMG. Notably, due to government restructures since the ARC report was prepared, many key government stakeholders who expressed interest in the project and made submissions during the EIS process now hold different names.

The list of potential project related social issues and impact areas of interest to the stakeholders was developed as part of scoping activities, having been drawn primarily from the 2010 Social and Economic Impact Assessment and the 2011 and 2015 Social Impact Management Plans for the Dugald River project.

Stakeholder groups have been ranked according to their likely influence/interest in the project in accordance with the criteria presented in Table 2. Table 3 summarises potential stakeholder groups by social issue/impact area, with a more detailed breakdown of the social issues/impacts available in Appendix A.

**Table 2 Criteria for ranking stakeholders by Project influence/interest**

High influence or interest in the project and the commissioned social performance work
Medium influence or interest in the project and commissioned the social performance work
Low influence or interest in the project and the commissioned social performance work

**Table 3 Potential key stakeholder by social issues/ impact areas**

Potential stakeholder groups	Key social issue/impact area
Local landholders and land users on neighbouring land <ul style="list-style-type: none"> <li>Mount Roseby Homestead</li> </ul>	<ul style="list-style-type: none"> <li>Land use</li> <li>Environment</li> <li>Traffic</li> </ul>
Indigenous groups and traditional owners <ul style="list-style-type: none"> <li>Kalkadoon Native Title Aboriginal Corporation – Registered Native Title Bodies Corporate</li> <li>the Mitakoodi Aboriginal Corporation</li> <li>Carpentaria Land Council Aboriginal Corporation</li> <li>Queensland South Native Title Services</li> </ul>	<ul style="list-style-type: none"> <li>Economic development and benefit</li> <li>Training and employment</li> <li>Community values and heritage</li> <li>Land use</li> </ul>
Councils <ul style="list-style-type: none"> <li>Cloncurry Shire Council</li> <li>Townsville City Council</li> <li>Mount Isa City Council</li> </ul>	<ul style="list-style-type: none"> <li>Economic development and benefit</li> <li>Training and employment</li> <li>Housing</li> <li>FIFO lifestyle</li> <li>Environment</li> <li>Social profile</li> <li>Community values and heritage</li> <li>Cumulative impacts</li> <li>Community services</li> </ul>

<p>State Departments</p> <ul style="list-style-type: none"> <li>• State Development, Manufacturing, Infrastructure and Planning</li> <li>• Aboriginal and Torres Strait Islander Partnerships</li> <li>• Housing and Public Works</li> <li>• Employment, Small Business and Training</li> <li>• Communities, Disability Services and Seniors</li> <li>• Child Safety, Youth and Women</li> <li>• Transport and Main Roads</li> <li>• Fire and Emergency Services</li> <li>• Education</li> <li>• Natural Resources, Mines and Energy</li> <li>• Police</li> <li>• Health</li> <li>• Agriculture and Fisheries</li> <li>• Innovation, Tourism, Industry Development and the Commonwealth Games</li> </ul>	<ul style="list-style-type: none"> <li>• Traffic</li> <li>• Economic development and benefit</li> <li>• Training and employment</li> <li>• Environment</li> <li>• Cumulative impacts</li> <li>• Community services</li> </ul>
<p>Other emergency services</p> <ul style="list-style-type: none"> <li>• Queensland Ambulance Service</li> <li>• State Emergency Service</li> <li>• CareFlight</li> </ul>	<ul style="list-style-type: none"> <li>• Cumulative impacts</li> <li>• Community services</li> </ul>
<p>Non-governmental organisations</p> <ul style="list-style-type: none"> <li>• Southern Gulf Natural Resource Management</li> </ul>	<ul style="list-style-type: none"> <li>• Environment</li> <li>• Cumulative impacts</li> </ul>
<p>Industry groups and businesses</p> <ul style="list-style-type: none"> <li>• Construction, Forestry, Mining and Energy Union</li> <li>• Multi-Skill Centre</li> <li>• Glencore</li> <li>• CuDeco Limited</li> <li>• Copper Mountain Mining Corporation</li> <li>• CuString</li> <li>• CS Energy</li> <li>• Ergon Energy</li> <li>• Sunwater</li> <li>• Local Chambers of Commerce</li> <li>• Queensland Resources Council</li> <li>• Townsville Enterprise</li> <li>• Mount Isa to Townsville Economic Development Zone</li> </ul>	<ul style="list-style-type: none"> <li>• Economic development and benefit</li> <li>• Training and employment</li> <li>• Cumulative impacts</li> </ul>
<p>Community and underrepresented groups</p> <ul style="list-style-type: none"> <li>• Cloncurry Justice Association</li> <li>• Country Women's Association</li> <li>• Rotary Club of Cloncurry</li> <li>• Lions Club of Cloncurry</li> <li>• Cloncurry and District Historical and Museum Society</li> <li>• Sisters of the North</li> </ul>	<ul style="list-style-type: none"> <li>• Economic development and benefit</li> <li>• Community values and heritage</li> <li>• Social profile</li> <li>• Cumulative impacts</li> </ul>
<p>Local residents</p> <ul style="list-style-type: none"> <li>• Cloncurry and surrounding areas</li> </ul>	<ul style="list-style-type: none"> <li>• Economic development and benefit</li> <li>• Training and employment</li> <li>• Housing</li> <li>• Environment</li> <li>• Social profile</li> <li>• Community values and heritage</li> <li>• Cumulative impacts</li> <li>• Community services</li> <li>• Traffic</li> </ul>
<p>Dugald River mine employees</p>	<ul style="list-style-type: none"> <li>• Economic development and benefit</li> <li>• Training and employment</li> <li>• FIFO lifestyle</li> </ul>



## 6. Information requirements from stakeholders

Nation Partners has drafted an SBS report and is in the process of drafting a SIOA using desktop information. We have reviewed the information available and identified gaps and in some cases anomalies in the data and literature which require further investigation directly with stakeholders (see Table 3). In order to support the engagement being of the most value, we plan to discuss the preliminary findings of our work (i.e. from the SBS and SIOA) with stakeholders, and use the identified topics in Table 4 to formulate insightful questions helpful to completing the key deliverables.

**Table 4 Information needs from community and stakeholder engagement**

SBS Requirements	SIOA, SIMP and Social Investment Requirements*
<p>Additional information on the existing or baseline conditions, with particular focus on:</p> <ul style="list-style-type: none"> <li>• Underlying factors driving fluctuations in the population over time and its overall decline</li> <li>• Understanding the volatility of the local unemployment rate and recent increase (as of December 2018)</li> <li>• Exploring the connection between the opening and closing of mines on local employment levels</li> <li>• Investigate the above average turnover of local businesses</li> <li>• Confirming the assumption that average incomes for the Cloncurry Local Government Area (LGA) and Indigenous population of Cloncurry LGA are due to the presence of well-paid mining industry employment opportunities</li> <li>• Understanding the extent to which volunteering levels correlate with local community pride and whether there is any explanation for differences between Cloncurry LGA and the Indigenous population of Cloncurry LGA</li> <li>• Investigating the nature and magnitude of disadvantage as an issue in the community, in light of the Index of Socio-Economic Disadvantage reported for the community</li> <li>• Investigating the above average level of developmentally vulnerable children reported to be entering school</li> <li>• Confirming the assumption that lower than average education levels yet high levels of income in the community, result from low skill and high pay mining jobs</li> <li>• Further investigating disparity between Indigenous and non-Indigenous education, employment and income</li> <li>• Uncovering what the high level of “other” dwelling structures in the community incorporates</li> <li>• Exploring the fundamentals of the local housing rental market and the fluctuations in rental prices over time</li> <li>• Investigating mobility/ the transience of the population</li> </ul>	<p>Confirm relevance/ significance of impacts identified to date and adequacy of current management and mitigation and monitoring requirements with focus on:</p> <ul style="list-style-type: none"> <li>• Evaluating local and regional economic benefit, including lost opportunities due to FIFO workforce</li> <li>• Understanding expectations for community investment</li> <li>• Assessing the benefit of training, graduate studies, vacation, scholarship and employment opportunities for local community members</li> <li>• Understanding the positive and negative aspects of FIFO lifestyle for relevant Dugald River mine employees</li> <li>• Exploring impacts to community culture, values and lifestyle due to FIFO workforce</li> <li>• Investigating impacts on land use for nearby residents and Native Title claimants</li> <li>• Understanding the environmental impacts (noise, dust, vibration, traffic) of the project, particularly in reference to nearby landholders and the community</li> <li>• Exploring the trend of local residents gaining employment and transferring to FIFO leading to a reduction in local population</li> <li>• Understanding impact to the values and lifestyle of the local community, including effect on social order</li> <li>• Understanding impact to Indigenous community culture</li> <li>• Investigating cumulative impacts across the majority of described impacts</li> <li>• Discussing project impacts on community services and traffic</li> </ul>

**SBS Requirements**

**SIOA, SIMP and Social Investment Requirements\***

- Gaining insights into the local culture, values and lifestyle (including Kalkadoon)
- Understanding the drivers and details regarding the elevated rate of reported offences in the area and any links to the project workforce
- Confirming any land use changes

\* Note this list is very preliminary in nature given many of these reports are not yet drafted or in very preliminary draft form.

**7. Proposed methodology**

**Step 1: MMG review stakeholder list and engagement approach**

Nation Partners requests that MMG review and confirm the adequacy and appropriateness of the list of potential key stakeholders profiled above in Table 3, in addition to the proposed approach and timelines set out in this plan and provide feedback. We anticipate that further refinements may occur following the initial round of phone interviews (i.e., with some stakeholders listed potentially indicating that they do not need or desire to be further involved as stakeholders).

See Appendix B for a table which profiles potential key stakeholders, their contact details and planned methods of engagement, noting that we will operate flexibly and adjust our approach and methods of engagement to suit stakeholder preferences wherever possible.

**Step 2: Coordinate dates for face-to-face engagement**

Nation Partners is keen to lock in dates for face-to-face community and stakeholder engagement as soon as possible to ensure team availability. In consideration of the proposed project delivery schedule, the preexisting commitments of team members and being conscious to avoid school holidays<sup>1</sup>, we have proposed that the first visit occur the week starting Monday 17 June (from Wednesday 19 June to Friday 21 June). We suggest that the second trip occur in late August the week starting Monday 19 August or Monday 26 August to allow for stakeholder and community engagement on the full spectrum of social performance reports being prepared, and in particular the SIMP and SIP.

**Step 3: Nation Partners attend Community Consultative Committee (CCC) and Kalkadoon meetings**

Given the importance of providing MMG’s stakeholders with timely and relevant information, Nation Partners prepared some PowerPoint slides (Appendix C) about the work being conducted and the planned engagement activities which were shared with attendees of the Kalkadoon and CCC meetings on 23 May 2019. Introducing the Nation Partners team and this work is expected to help ensure stakeholders are well aware of, and informed, about this work with maximum opportunity to participate. This step will have provided a foundation for engagement to commence with these key stakeholders imminently.

**Step 4: Make initial contact with potential key stakeholders**

Nation Partners will phone stakeholders to confirm the contact information we hold is correct, introduce ourselves and this scope of work, confirm stakeholder interest levels, and set up a telephone interview time and/or face-to-face interview time. In some instances, stakeholders may be open to participating in an interview at the time of the initial introductory call, while others will likely schedule it in for another time. Flexibility is at the heart of our approach and therefore we will attempt to cater to the preferences of all stakeholders.

In addition to making an introductory phone call, we also propose to send all stakeholders an email following up, to summarise the project information and confirm any agreed future time for a phone or face-to-face

<sup>1</sup>QLD school holiday no-go consultation periods include (5 April – 23 April, 28 June -15 July, and 20 September – 8 October)

interview or focus group. See Appendix D for a template email, which we would tailor slightly depending the type of stakeholder and the nature of the initial communication.

For low influence/interest stakeholders, email will be the primary form of engagement, with stakeholders notified about the social performance work in progress and invited to get in touch/ participate if desired. See Appendix E for a proposed standardised template email, which we would tailor slightly for some stakeholders as appropriate.

#### **Step 5: Undertake round 1 phone interviews**

We will attempt to do phone interviews with as many stakeholders as possible, and if this falls through or there are still gaps at the end of these interviews, we can subsequently undertake a face-to-face interview or follow up by email or further phone interviews. In general, each call will include an introduction of Nation Partners and this scope of work (in high level detail only and to the extent required depending on the nature of any previous introductory call), an overview of some of our main findings from preliminary phase of reporting, and a number of questions aimed to expand our understanding of some of the baseline conditions and also impacts from a local perspective. The phone interviews will vary by stakeholder depending on their interests/influence and the information gaps (see Table 4) of relevance to given stakeholders. We will also make sure to express our and MMG's gratitude for the time and participation offered by stakeholders, invite any questions and provide next steps/ a plan for follow up.

#### **Step 6: Undertake round 1 face-to-face Interviews and focus group sessions**

Round 1 face-to-face interviews will be similar in structure to round 1 phone interviews detailed above, except that they will be held in person. We will plan to bring some copies of the preliminary reports in the event that stakeholders request to view them, and to talk through any anomalies (i.e. point to graphs).

While the focus group sessions will be similar to the above, they will likely be a little more formal in structure and we will have a few power point slides available to use if desired. Depending on attendance levels, and how receptive the stakeholders are to responding to questions with an audience, we may opt to provide printed handouts with areas we are seeking input and encourage stakeholders to get in touch for personal interviews or to give feedback privately. We will run focus groups with cultural sensitivity and in an agile manner, adjusting our approach as we lead the engagement to get the most value out of it.

#### **Step 7: Draft summary report and integrate feedback into reporting**

Nation Partners will draft a report summarising the findings of community engagement and integrate these into the SBS, SIOA and SIMP as appropriate.

#### **Step 8: Undertake round 2 phone interviews**

Once the reporting has progressed further, we will undertake a second round of phone interviews, primarily to demonstrate how the initial inputs have been used and to present the proposed mitigations, social investments and monitoring plans to stakeholders.

We will consult with MMG on any new mitigation and social investment initiatives we are recommending before they are discussed during these interviews, to ensure they are realistic options and something MMG is open to committing to. Equally if new mitigations are raised through the engagement process by stakeholders, we will invite conversation to understand why something has been proposed but be very careful in how we discuss any such recommendations. Our messaging will be that we appreciate all inputs and suggestions, and will investigate recommendations further and discuss them with MMG before a decision can be made about whether they will become formally adopted as an MMG commitment in the SIMP. This is very important so that we effectively temper expectations and do not end up putting MMG in a position of seeming to over promise and under deliver.

#### **Step 9: Undertake round 2 face-to-face Interviews and focus group sessions**

Round 2 face-to-face interviews will also be similar to the round 2 phone interviews described above with the focus on mitigations, social investment initiatives and monitoring. We will use any learnings from round 1 to improve the focus group sessions. We will provide printed hand-outs summarising the main items we would like input and feedback on, and once again if individuals are uncomfortable providing feedback as part of a group, we will invite stakeholders to follow up with us individually.

### Step 10: Finalise engagement summary report and integrate feedback into reporting

Nation Partners will add to and finalise the report summarising the findings of community engagement and integrate relevant findings into the SIOA, SIMP, SIP and LEMP as appropriate.

## 8. Engagement schedule

Activity	Purpose	Timeframe
<b>MMG review draft CEP</b>	<ul style="list-style-type: none"> <li>Ensure approach is aligned with MMG's expectation for stakeholder engagement</li> <li>Confirm proposed messaging to stakeholders</li> <li>Approve materials for CCC and Kalkadoon meetings</li> </ul>	w/c 20 May 2019
<b>CCC meeting</b> <ul style="list-style-type: none"> <li>Includes short presentation on social performance work</li> <li>JM and OW to dial-in to introduce themselves and the work</li> </ul>	<ul style="list-style-type: none"> <li>Introduce Nation Partners and the social performance work</li> <li>Ensure the CCC are fully briefed and know what to expect for upcoming engagement</li> </ul>	23 May 2019
<b>Kalkadoon Native Title Aboriginal Corporation (KNTAC) meeting</b> <ul style="list-style-type: none"> <li>Includes short presentation on social performance work</li> </ul>	<ul style="list-style-type: none"> <li>Introduce Nation Partners and the social performance work</li> <li>Ensure the KNTAC are fully briefed and know what to expect for upcoming engagement</li> </ul>	23 May 2019
<b>Initial contact with stakeholders</b> <ul style="list-style-type: none"> <li>Phone call, supplemented with email for medium and high influence/interest stakeholders</li> <li>Email only to most low influence/interest stakeholders</li> <li>Refer to Appendix B for list of</li> </ul>	<p>Introductory phone call:</p> <ul style="list-style-type: none"> <li>Confirm contact information is correct</li> <li>Introduce Nation Partners and the social performance work</li> <li>Confirm stakeholder interest levels</li> <li>Set time for phone and/or face-to-face interview, or undertake during call if desired</li> </ul> <p>Email follow-up:</p> <ul style="list-style-type: none"> <li>Summarise project information</li> <li>Confirm time for future engagement (phone, face-to-face, focus group)</li> </ul> <p>Alternate introductory email:</p> <ul style="list-style-type: none"> <li>Introduce Nation Partners and the social performance work</li> </ul>	w/c 27 May 2019

stakeholders and contact details	<ul style="list-style-type: none"> <li>Invite stakeholder to get in contact if interested in learning more/ participating</li> </ul>	
<b>Round 1 phone interviews</b>	<ul style="list-style-type: none"> <li>Provide overview of main findings from preliminary phase of reporting</li> <li>Expand understanding of baseline conditions and impacts from a local perspective</li> </ul>	w/c 3 June 2019 and 10 June 2019
<b>Evaluation and gap assessment of round 1 phone interviews</b>	<ul style="list-style-type: none"> <li>Determine any gaps from phone interviews and confirm follow-up requirements (face-to-face or focus sessions)</li> </ul>	w/c 10 June 2019
<b>Round 1 face-to-face interview and focus group sessions</b>	<ul style="list-style-type: none"> <li>Provide overview of main findings from preliminary phase of reporting</li> <li>Expand understanding of baseline conditions and impacts from a local perspective</li> </ul> <p>Focus group sessions:</p> <ul style="list-style-type: none"> <li>Capture a specific group's perspective on baseline conditions and impacts</li> </ul>	w/c 17 June 2019
<b>Draft summary report and integrate feedback into reporting</b>	<ul style="list-style-type: none"> <li>Provide MMG with a summary of findings from Round 1</li> <li>Increase usefulness and relevance of SBS, SIOA and SIMP by integrating up-to-date qualitative information</li> </ul>	w/c 24 June 2019 – 22 July 2019
<b>Round 2 phone interviews</b>	<ul style="list-style-type: none"> <li>Demonstrate how feedback captured during Round 1 has been used</li> <li>Present proposed mitigations, social investments and monitoring plans to stakeholders</li> </ul>	w/c 29 July 2019 and w/c 5 August 2019
<b>Evaluation and gap assessment of round 2 phone interviews</b>	<ul style="list-style-type: none"> <li>Determine any gaps from phone interviews and confirm follow-up requirements (face-to-face or focus sessions)</li> </ul>	w/c 12 August 2019
<b>Round 2 face-to-face interview and focus group sessions</b>	<ul style="list-style-type: none"> <li>Demonstrate how feedback captured during round 1 has been used</li> <li>Present proposed mitigations, social investments and monitoring plans to stakeholders and invite further feedback</li> </ul>	w/c 19 August 2019 OR w/c 26 August 2019
<b>Finalise engagement summary report and integrate feedback into reporting</b>	<ul style="list-style-type: none"> <li>Provide MMG with a final summary of all findings</li> <li>Increase usefulness and relevance of SIOA, SIMP, SIP and LEMP by integrating up-to-date qualitative information</li> </ul>	w/c 2 September 2019 – w/c 9 September 2019 <i>(may start earlier depending on above)</i>
<b>Close-the-loop with stakeholders</b>	<ul style="list-style-type: none"> <li>Thank stakeholders for participating in the process and provide information around what their outputs will be / has been used for</li> </ul>	w/c 9 September 2019
<ul style="list-style-type: none"> <li>Via email</li> </ul>		

nation  
partners

SOLUTIONS FOR  
COMPLEX PROJECTS

Appendices





## Appendix A - Issues Scoping

Table 1 outlines impact areas identified as part of the 2010 Social and Economic Impact Assessment and the 2011 and 2015 Social Impact Management Plans for the Dugald River Project.

**Table 1 Key social impact areas**

Impact	2010 SEIA	2011 SIMP	2015 SIMP
<b>Economic Development and Benefit</b>			
Positive impact on regional economic development	X	X	
Local economic benefit via investment, purchasing of consumables and use of certain service industries	X		X
Economic benefit via payment of royalties and taxes to QLD Government	X		
Lost opportunity for/ reduced local economic benefit to some services in Cloncurry due to large FIFO workforce	X		X
Increased expectation for community investment			X
Intercity rivalries (Mount Isa and Cloncurry) for mine derived benefits			X
<b>Training and Employment</b>			
Training and employment opportunities for local Indigenous and non-indigenous people	X	X	
Training, graduate studies, vacation work and scholarship programs provided to employees and students	X		
<b>Housing</b>			
Minimal impact to accommodation and housing market in Cloncurry due to FIFO workforce	X		
Impact on short-term accommodation		X	
<b>FIFO lifestyle</b>			
Positive aspects of FIFO lifestyle including more quality family and leisure time, and financial incentives	X		

Impact	2010 SEIA	2011 SIMP	2015 SIMP
Negative aspects of FIFO lifestyle including extended absences from families and insufficient rest for employees	X	X	
Reduced community participation in Cloncurry due to FIFO workforce			X
<b>Land use</b>			
Impact on land for nearby residents, including reduction of grazing area due to the Project infrastructure footprint	X	X	X
Impact on land for Native Title claimants	X	X	X
<b>Environment</b>			
Potential impact to the liveability and quality of lifestyle for nearby landholders and community	X	X	
Environmental impacts including noise, vibration, dust, lighting and visual amenity		X	X
Impact on local water security			X
Increase in uncontrolled pests and feral flora in Project area			X
Increase in noise, dust, traffic from Cloncurry load out facility			X
Increase in dust, noise, traffic at Townsville Port			X
Impact of mine closure		X	
<b>Social profile</b>			
Minimal impact expected on population size and structure of Cloncurry	X		
No contribution to population growth or diversity in Cloncurry due to FIFO nature of the work	X		
Local employees gain employment and transfer to FIFO leading to a reduction in local population*			
<b>Community values and heritage</b>			
Continuing tradition of mining playing a major role in the historical and cultural background of Cloncurry	X		

Impact	2010 SEIA	2011 SIMP	2015 SIMP
Negative impact on social amenity, community values and lifestyle		X	
Impact to Indigenous cultural heritage	X	X	X
Impact to historical cultural heritage			X
Impact to social order		X	
<b>Cumulative impacts</b>			
General cumulative impacts across majority of described impacts	X	X	
Impact to services without active social contribution to town	X		
Increased house and rental prices	X		
Spike in antisocial behaviour such a crime, vandalism and alcoholism	X		X
<b>Community services</b>			
Impact to health services		X	
Impact to education		X	
Impact to emergency services		X	
Expectation that commercial airline services will remain due to the Project			X
<b>Traffic</b>			
Impact on public safety on highway and roads		X	
Increased road traffic from mining operations			X

## Appendix B – Proposed Stakeholder engagement method

**Table 2 Stakeholder contact details and anticipated method of engagement**

Stakeholder	Contact details	CCC Member?	Anticipated engagement method
Mount Roseby Homestead landowners	<b>Harold and Catherine McMillan</b> 0427 425 904 <a href="mailto:mtroseby@bigpond.com">mtroseby@bigpond.com</a>	Yes	Phone call, supplemented with email. Phone interviews and/or face-to-face interviews/focus groups with residents of all affiliated homesteads invited.
Corella Park Station landowners	<b>Anthony and Jane McMillan</b> 0417 799 063 <a href="mailto:corellapark@reachnet.com.au">corellapark@reachnet.com.au</a>	Yes	Phone call, supplemented with email. Phone interviews and/or face-to-face interviews/ focus groups combined at Mount Roseby Homestead.
Landowners (pastoralists)	<b>Mark and Chelsea McMillan</b> <i>MMG to provide</i>	Yes	Phone call, supplemented with email. Phone interviews and/or face-to-face interviews/focus groups combined at Mount Roseby Homestead.
	<b>Allan and Brooke Adby</b> (07) 4742 1227		Phone call, supplemented with email. Phone interviews and/or face-to-face interviews/focus groups (on request).
	<b>David and Tracy Corbett</b> (07) 4742 1085		Phone call, supplemented with email. Phone interview and/or face-to-face interviews/focus groups (on request).
Kalkadoon Native Title Aboriginal Corporation	<b>Virginia Mayo</b> (Board Member) <b>Kurt</b> (Board Member) <b>Dorsey</b> (Board Member) <b>Jenny</b> (Board Member) (07) 4749 2766 <a href="mailto:admin@kalkadoonpbc.com.au">admin@kalkadoonpbc.com.au</a> 109 Barkly Highway, Mount Isa QLD 4825 (office address)	Yes	Phone call, supplemented with email. Two focus group sessions plus interviews as specified.
	<b>Dorothea Seumanutafa</b> (admin support) Same as above	No	N/A – will liaise with to facilitate engagement with board members

Stakeholder	Contact details	CCC Member?	Anticipated engagement method
Queensland South Native Title Services	<p><b>Kelly Thomas-Greer</b> (Assistant Legal Manager) (07) 3224 1200 <a href="mailto:kelly.thomasgreer@qsnts.com.au">kelly.thomasgreer@qsnts.com.au</a> Level 10, 307 Queen Street, Brisbane QLD 4000 (head office address)</p>	No	Phone call, supplemented with email. Phone interview/s.
Mitakoodi Aboriginal Coroproation	<p><b>Beverly Wardrop</b> (Manager) (07) 4742 1208 <a href="mailto:mitakoodi@gmail.com">mitakoodi@gmail.com</a> 55 King Street, Cloncurry QLD 4824</p>	No	Phone call, supplemented with email. Phone interviews and/or face-to-face interviews/ focus groups.
Carpentaria Land Council Aboriginal Corporation	<p>Cairns Office: (07) 4041 3833 <a href="mailto:info@clcac.com.au">info@clcac.com.au</a> PO Box 6662 Cairns QLD 4870</p>	No	Email introducing SP work. Phone interview/s on request.
Cloncurry Shire Council	<p><b>Greg Campbell</b> (Mayor) 0484 829 444 <a href="mailto:Mayor@cloncurry.qld.gov.au">Mayor@cloncurry.qld.gov.au</a> <b>David Bezuidenhout</b> (CEO) 0439 294 747 <a href="mailto:DavidB@cloncurry.qld.gov.au">DavidB@cloncurry.qld.gov.au</a> 38-46 Daintree Street, Cloncurry (office address)</p>	Yes	Phone call/s, supplemented with email/s. Focus group sessions plus interviews as specified.
	<p><b>Dane Swalling</b> (Deputy Mayor) 0408 019 691 <a href="mailto:crdswalling@cloncurry.qld.gov.au">crdswalling@cloncurry.qld.gov.au</a> 38-46 Daintree Street, Cloncurry (office address)</p>	No	Invite to focus group sessions
Mount Isa City Council	<p><b>Joyce McCulloch</b> (Mayor) <a href="mailto:mayorjoyce@mountisa.qld.gov.au">mayorjoyce@mountisa.qld.gov.au</a> <b>Sharon Ibardolaza</b> (CEO) <a href="mailto:SharonI@mountisa.qld.gov.au">SharonI@mountisa.qld.gov.au</a> (07) 4747 3200 23 West Street, Mount Isa QLD 4825 (office address)</p>	Yes	Phone calls, supplemented with emails. Face to-face interviews/ focus groups.

Stakeholder	Contact details	CCC Member?	Anticipated engagement method
Townsville City Council	<p><b>Jenny Hill</b> (Mayor) <a href="mailto:jenny.Hill@townsville.qld.gov.au">jenny.Hill@townsville.qld.gov.au</a></p> <p><b>Mike Chiodo</b> (CEO) <a href="mailto:Mike.Chiodo@townsville.qld.gov.au">Mike.Chiodo@townsville.qld.gov.au</a> 13 48 10 103 Walker Street, Townsville QLD 4810 (office address)</p>	No	Phone calls, supplemented with emails. Phone interview/s.
Department of State Development, Manufacturing, Infrastructure and Planning	<p><b>Tammy Parry</b> (Regional Director) (07) 4747 3909 <a href="mailto:tammy.parry@dsdmip.qld.gov.au">tammy.parry@dsdmip.qld.gov.au</a></p> <p><b>Darren Cleland</b> (Executive Regional Director) 0417 007 571 <a href="mailto:darren.cleland@dsdmip.qld.gov.au">darren.cleland@dsdmip.qld.gov.au</a> PO Box 15009, City East QLD 4002</p>	Yes	Phone calls, supplemented with emails. Phone interview/s.
Department of Environment and Science	<p><b>Ingrid Fomiatti Minnesma</b> (Director Minerals) 0412 588 475 <a href="mailto:ingrid.fomiattiminnesma@des.qld.gov.au">ingrid.fomiattiminnesma@des.qld.gov.au</a> GPO Box 2454, Brisbane QLD 4001</p>	No	Email introducing SP work. Phone interview/s on request.
Department of Transport and Main Roads	<p><b>Mark Desira</b> (Inspector of Mines – Occupational Hygiene) 0467 808 736 <a href="mailto:mark.desira@dnrme.qld.gov.au">mark.desira@dnrme.qld.gov.au</a></p> <p><b>Andrew Hobbs</b> (Director) 0405 506 019 <a href="mailto:Andrew.r.hobbs@tmr@qld.gov.au">Andrew.r.hobbs@tmr@qld.gov.au</a></p> <p><b>Sandra Voll</b> (Program Support Office, North West) (07) 4769 3249 <a href="mailto:Sandra.G.Voll@tmr.qld.gov.au">Sandra.G.Voll@tmr.qld.gov.au</a> PO Box 673 Fortitude Valley QLD 4006</p>	No	Email/s introducing SP work. Phone interview/s on request.



Stakeholder	Contact details	CCC Member?	Anticipated engagement method
Department of Aboriginal and Torres Strait Islander Partnerships	13 74 68 <a href="mailto:enquiries@datsip.qld.gov.au">enquiries@datsip.qld.gov.au</a> PO Box 15397 City East QLD 4002	No	Email introducing SP work. Phone interview/s on request.
Department of Housing and Public Works	13 74 68 <a href="mailto:DirectorGeneral@hpw.qld.gov.au">DirectorGeneral@hpw.qld.gov.au</a> GPO Box 2457 Brisbane QLD 4001	No	Email introducing SP work. Phone interview/s on request.
Department of Employment, Small Business and Training	13 74 68 <a href="mailto:info@desbt.qld.gov.au">info@desbt.qld.gov.au</a> PO Box 15033 City East Brisbane QLD 4002	No	Email introducing SP work. Phone interview/s on request.
Department of Communities, Disability Services and Seniors	13 74 68 1 William Street, Brisbane QLD 4000	No	Phone call to get correct contact email. Email introducing SP work. Phone interview/s on request.
Department of Child Safety, Youth and Women	13 74 68 1 William Street, Brisbane QLD 4000	No	Phone call to get correct contact email. Email introducing SP work. Phone interview/s on request.
Queensland Fire and Emergency Services	13 74 68 <a href="mailto:QFESenquiries@qfes.qld.gov.au">QFESenquiries@qfes.qld.gov.au</a> GPO Box 1425, Brisbane QLD 4001	No	Email introducing SP work. Phone interview/s on request.
Department of Education	13 74 68 PO Box 15033, City East QLD 4002	No	Phone call to get correct contact email. Email introducing SP work. Phone interview/s on request.
Department of Natural Resources, Mines and Energy	North West Region (07) 4747 2158 <a href="mailto:isamines@dnrme.qld.gov.au">isamines@dnrme.qld.gov.au</a> PO Box 334, Mount Isa QLD 4825	No	Email introducing SP work. Phone interview/s on request.
Queensland Police	131 444 (07) 3055 6206 GPO Box 1440, Brisbane QLD 4000	No	Phone call to get correct contact email. Email introducing SP work. Phone interview/s on request.
Queensland Health	13 74 68 GPO Box 48, Brisbane QLD 4001	No	Phone call to get correct contact email. Email introducing SP work. Phone interview/s on request.
Department of Agriculture and Fisheries	13 25 23 <a href="mailto:info@daf.qld.gov.au">info@daf.qld.gov.au</a> GPO Box 46, Brisbane QLD 4001	No	Phone call to get correct contact email. Email introducing SP work. Phone interview/s on request.

Stakeholder	Contact details	CCC Member?	Anticipated engagement method
Innovation, Tourism, Industry Development and the Commonwealth Games	13 74 68 PO Box 15168, City East QLD 4002	No	Phone call to get correct contact email. Email introducing SP work. Phone interview/s on request.
Queensland Ambulance Service	13 74 68 GPO Box 1425 Brisbane QLD 4001	No	Phone call to get correct contact email. Email introducing SP work. Phone interview/s on request.
State Emergency Service	(07) 4743 2601 <a href="mailto:SESNR.Admin@qfes.qld.gov.au">SESNR.Admin@qfes.qld.gov.au</a> 1/173 Camooweal Street, Mount Isa QLD 4825 Note: Cloncurry Office in Alice Street	No	Email introducing SP work. Phone interview/s on request.
CareFlight	Mount Isa and the North West Region (07) 4743 0937 1/24 West Street, Mount Isa QLD 4825	No	Phone call to get correct contact email. Email introducing SP work. Phone interview/s on request.
Southern Gulf Natural Resource Management	(07) 4743 1888 <a href="mailto:admin@southerngulf.com.au">admin@southerngulf.com.au</a> PO Box 2211, Mount Isa QLD 4825	No	Email introducing SP work. Phone interview/s on request.
Construction, Forestry, Mining and Energy Union	CFMEU Brisbane (07) 3231 4600 <a href="mailto:gntqueries@cfmeu.org">gntqueries@cfmeu.org</a> 16 Campbell Street, Bowen Hills QLD 4006	No	Email introducing SP work. Phone interview/s on request.
Multi-Skill Centre	(07) 4742 2887 <a href="mailto:paul@multiskillcentre.com.au">paul@multiskillcentre.com.au</a> 32-36 Short Street, Cloncurry QLD	No	Phone call, supplemented with email. Phone interviews or face-to-face interviews (on request)
Glencore	Glencore Brisbane (07) 3833 8500 10/160 Ann Street, Brisbane QLD 4000	No	Phone call to get correct contact email. Email introducing SP work. Phone interview/s on request.
CuDeco Limited	(07) 4742 4800 <a href="mailto:cloncurry@cudeco.com.au">cloncurry@cudeco.com.au</a> Corella Park Road, Cloncurry QLD 4824	No	Email introducing SP work. Phone interview/s on request.
Copper Mountain Mining Corporation	(08) 9485 2929 1/2 Kings Park Road, West Perth WA 6005	No	Phone call to get correct contact email. Email introducing SP work. Phone interview/s on request.

Stakeholder	Contact details	CCC Member?	Anticipated engagement method
CuString	No contact information currently available (project soon to go through EIS process, so expected in near future)	No	Phone call to get correct contact email. Email introducing SP work. Phone interview/s on request.
CS Energy	(07) 3854 7777 PO Box 2227, Fortitude Valley BC QLD 4006	No	Phone call to get correct contact email. Email introducing SP work. Phone interview/s on request.
Ergon Energy	13 74 66 PO Box 1090 Townsville QLD 4810	No	Phone call to get correct contact email. Email introducing SP work. Phone interview/s on request.
Sunwater	(07) 3120 0000 9/515 St Pauls Terrace, Fortitude Valley QLD 4006	No	Phone call to get correct contact email. Email introducing SP work. Phone interview/s on request.
Local Business Network Cloncurry	Contact via Council (07) 4742 4100 <a href="mailto:council@cloncurry.qld.gov.au">council@cloncurry.qld.gov.au</a> 38-46 Daintree Street, Cloncurry QLD 4824	No	Phone call, supplemented with email. Phone interview or face-to-face interview (on request)
Queensland Resources Council	<b>Ian Macfarlene</b> (CEO) (07) 3295 9560 <a href="mailto:info@qrc.org.au">info@qrc.org.au</a> 13/133 Mary Street, Brisbane QLD 4000	No	Email introducing SP work. Phone interview/s on request.
Townsville Enterprise	<b>Patricia O'Callaghan</b> (CEO) (07) 4726 2733 <a href="mailto:patricia.ocallaghan@tel.com.au">patricia.ocallaghan@tel.com.au</a> PO Box 1043, Townsville QLD 4810	No	Email introducing SP work. Phone interview/s on request.
Mount Isa to Townsville Economic Development Zone	<b>David Glasson</b> (President) <b>Glen Graham</b> (CEO) (07) 4743 3488 0428 781 594 <a href="mailto:ceo@mitez.com.au">ceo@mitez.com.au</a> PO Box 1258, Mount Isa QLD 4825	No	Phone call, supplemented with email. Phone interview/s.
Cloncurry Justice Association	<b>Judith Ontronen</b> (Manager) (07) 4742 0846 <a href="mailto:cloncurryjustice@bigpond.com">cloncurryjustice@bigpond.com</a>	No	Email introducing SP work. Phone interview/s on request.

Stakeholder	Contact details	CCC Member?	Anticipated engagement method
	12 Ramsay Street, Cloncurry QLD 4824		
Country Women's Association	<b>Sarah Harvey</b> (President) 0414 187 052 <a href="mailto:cloncurrycwa@gmail.com">cloncurrycwa@gmail.com</a>	No	Phone call, supplemented with email. Phone interview or face-to-face interview (on request).
Rotary Club of Cloncurry	(02) 8894 9800 Matilda Highway, Cloncurry QLD 4824	No	Email introducing SP work. Phone interview/s on request.
Cloncurry Lions Club	1800 655 201 PO Box 279, Cloncurry QLD 4824	No	Email introducing SP work. Phone interview/s on request.
Cloncurry and District Historical and Museum Society	<b>John Walton</b> (President) 0429 664 907 <a href="mailto:gail.wipaki@bigpond.com">gail.wipaki@bigpond.com</a>	No	Email introducing SP work. Phone interview/s on request.
Eagles Football Club	<b>John and Susan Swalling</b> 0428 421 573 <a href="mailto:wallingcnj@gmail.com">wallingcnj@gmail.com</a>	Yes	Phone call, supplemented with email. Phone interview or face-to-face interview (on request).
Cloncurry Merry Muster	<b>Janessa Bidgood</b> 0429 855 734 <a href="mailto:outbackauctions@bigpond.com">outbackauctions@bigpond.com</a>	Yes	Email introducing SP work. Phone interview/s on request.
Sisters of the North	Susan Dowling 0429 467 300 <a href="mailto:susanldowling@gmail.com">susanldowling@gmail.com</a>	Yes	Email introducing SP work. Phone interview/s on request.
Bowls Club	<b>Kevin Wherman (Bungie)</b> 0409 476 978 <a href="mailto:adm@krcontracting.com.au">adm@krcontracting.com.au</a> <b>Damien McGee</b> 0418 713 608 <a href="mailto:manager@ozecool.com">manager@ozecool.com</a>	Yes	Email introducing SP work. Phone interview/s on request.
Local residents in Cloncurry and surrounding areas	n/a	n/a	Option to provide information about social performance work on Cloncurry Council website and community facebook page if desired
Dugald River mine employees	n/a	n/a	Employee survey

## Appendix C – Slide Pack for Community Consultative Group Meeting (and Kalkadoon meeting)



## Appendix D – Proposed messaging to Stakeholders (Follow-up email template)

Dear <insert name here>,

Thank you for your time on the phone <earlier, yesterday etc.>. As discussed, we have contacted you regarding work we are undertaking to support the social performance of the Dugald River mine, a zinc-lead-silver mine owned and operated by MMG 65 kilometres northwest of Cloncurry.

Nation Partners have been engaged to complete a number of social performance tasks (including a social baseline study, a social impact and opportunity assessment, a Social Impact Management Plan and a Social Investment Plan) which will support MMG to enhance the management of social impacts associated with the Dugald River mine on an ongoing basis, and benefit the local communities through positive social and economic development.

As discussed, we would like to engage with you to help us better understand the existing socio-economic characteristics of local communities, and investigate how these communities are impacted by the operation of Dugald River project or likely to be impacted in futures phases, both positively and negatively. We are also seeking input on social impact management and monitoring systems being developed for the Dugald River mine.

We would like to invite you to participate in a <phone> interview on <date> at <time>. If this does not suit, please contact us on the details below and we would be happy to arrange an alternative time. Please also get in touch if you have any questions or would like any further information on the work we are undertaking.

Thank you in advance for your participation. Your local knowledge will help us build our understanding of the issues and considerations unique to this area, and contribute to the long-term improvement of the social performance of the Dugald River mine.

We look forward to speaking to you soon.

Kind regards,



## Appendix E – Proposed messaging to Stakeholders (Primary engagement email for low influence/interest stakeholders)

Dear <inset name here>,

We are writing to you regarding work we are undertaking to support the social performance of the Dugald River mine, a zinc-lead-silver mine located 65 kilometres north-west of Cloncurry in north-western Queensland. The mine is owned and operated by MMG, the world's second largest producer of zinc and a substantial producer of copper, lead, gold and silver.

With construction of the mine now complete, and the achievement of commercial production having occurred in May 2018, MMG is seeking to update key documents and plans to contribute to the long-term improvement of the social performance of the Dugald River mine.

To complete this work, MMG have engaged Nation Partners - a trusted consultancy that provides solutions to complex problems and offer a wealth of local and international experience undertaking social performance activities on mining projects. We will be completing the following tasks:

- Preparing a social baseline study
- Creating a social impact and opportunity assessment
- Developing a Social Impact Management Plan
- Developing a Social Investment Plan

These documents and plans will support MMG to enhance the management of social impacts associated with the Dugald River mine on an ongoing basis, and benefit local communities through positive social and economic development.

You have been identified as a stakeholder who may have an interest in the work we are undertaking. We would like to engage with stakeholders who can help us better understand the existing socio-economic characteristics of local communities, and investigate how these communities are impacted by the operation of Dugald River project or likely to be impacted in futures phases, both positively and negatively. We are also seeking input on social impact management and monitoring systems being developed for the Dugald River mine.

If you are interested in participating in the community and stakeholder engagement to support this work, or would like more information, please contact us on the details below.

We look forward to speaking to you soon.

Kind regards,

## Appendix I: Minutes MMG/Kalkadoon July 2023

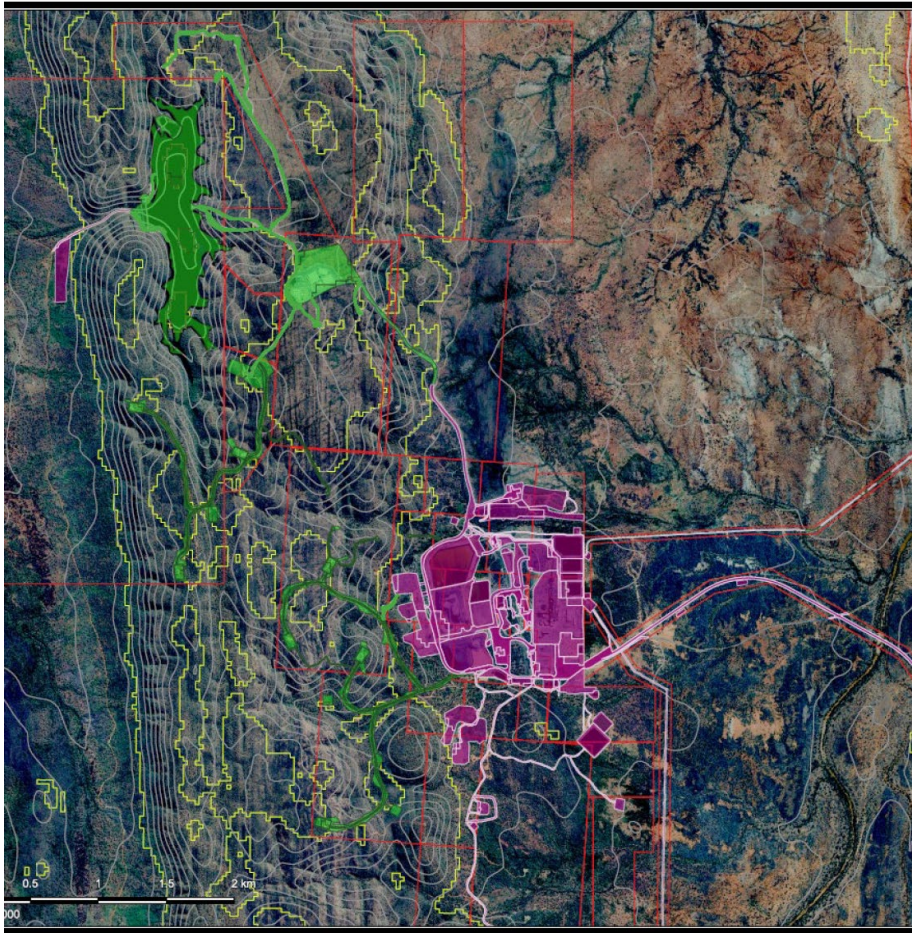
# Minutes

<b>Subject</b>	<b>MMG/Kalkadoon Meeting re: Change in PMLU</b>		
<b>Date and time</b>	Tuesday, 04 July 2023	<b>Time started</b>	08.30am
<b>Location</b>	Coffee Club, Mount Isa		
<b>Attendees</b>	Leigh Kirkhoffs (Kalkadoon People #4), Robert James (MMG), Nick Johnson (MMG)		
<b>Apologies</b>	None		
<b>Courtesy copy</b>	Department of Environment and Science		
<b>Chairperson</b>	N/A		
<b>Recorded by</b>	Nick Johnson		
<b>Distributed by</b>	Gemma Green		

Item	Description
1	<p><b>Proposed Change to Post Mining Land Use (PMLU)</b></p> <p><b>Issues Raised and Discussed:</b></p> <p>MMG outlined that as it currently stands, all land on the “flat” (not the Knapdale Range) is a combined PMLU of grazing and native ecosystem. Following consultation with the McMillan family it was identified that the preferred PMLU was a single use of grazing. MMG is seeking to make this change through the PRCP framework if the Kalkadoon People are supportive. Alternatively, MMG asked if the Kalkadoon People have a preferred PMLU.</p> <p>The below imagine was provided to Mr Kirkhoffs in A3 size and formed part of the discussion.</p> <p><b>How were the Issues Considered:</b></p> <p>Mr Kirkhoff, on behalf of the Kalkadoon People, support the change.</p> <p><b>Decision and Outcome:</b></p> <p>MMG will apply to DES to change the PMLU's as per the below image.</p>

Meeting closed at:	09.30am	Next meeting date and time:	N/A
--------------------	---------	-----------------------------	-----

# Minutes



## **Appendix J: Minutes MMG/McMillians October 2023**

# Minutes

Subject	MMG/Landholder Meeting		
Date and time	Monday, 23 October 2023	Time started	12.00pm
Location	Quamby Pub		
Attendees	Harold McMillan, Anthony McMillan, Tom McMillan, Robert James (MMG), Nick Johnson (MMG), Tim Akroyd (MMG)		
Apologies	None		
Courtesy copy	Department of Environment and Science		
Chairperson	N/A		
Recorded by	Robert James		
Distributed by	Gemma Green		

Item	Description
1	<p><b>Proposed Change to Post Mining Land Use (PMLU)</b></p> <p>Issues Raised and Discussed:</p> <p>MMG outlined that as it currently stands, all land on the “flat” (not the Knapdale Range) is a combined PMLU of grazing and native ecosystem. Through informal conversations MMG has become aware that the McMillan family would prefer a focus on grazing as a PMLU. It is noted that livestock cannot access the Knapdale Range as the terrain is too steep. MMG proposed that the PMLU for all land on the “flat” is changed to a grazing PMLU only.</p> <p>The attached “Figure 01: Proposed Post Mine Land Use” was provided to the McMillans and formed part of the discussion.</p> <p>How were the Issues Considered:</p> <p>The McMillan family supported the change in PMLU.</p> <p>Decision and Outcome:</p> <p>MMG will apply to DES to change the PMLU’s as per the attached map.</p>
2	<p><b>Proposed Wind Farm</b></p> <p>Issues Raised and Discussed:</p> <p>MMG provided an update to the McMillan family in relation to the WF application. Namely, that DES did not accept the initial application submitted by MMG. Discussion was held regarding conflicting messages from government and the McMillan family re-stated that they were supportive of the move to renewable energy technologies and would like to see a larger network developed that includes the entire Knapdale Range.</p> <p>How were the Issues Considered:</p> <p>MMG explained that under the EA process MMG is only able to apply for the turbines required to operate the mine. MMG went on to explain that we are holding discussions with other government departments and may look to follow a DA process in the future to allow for expansion. The McMillan family was supportive of this.</p> <p>Decision and Outcome:</p>



# Minutes

	MMG is actively addressing the matters raised by DES and plans to re-submit the EA Amendment application by 30 November 2023.
--	---

Meeting closed at:	1.30pm	Next meeting date and time:	N/A
--------------------	--------	-----------------------------	-----

